

Operation and Service Manual

Analog Limiter

SIM964



Stanford Research Systems

Revision 1.3 • May 17, 2006

Certification

Stanford Research Systems certifies that this product met its published specifications at the time of shipment.

Warranty

This Stanford Research Systems product is warranted against defects in materials and workmanship for a period of one (1) year from the date of shipment.

Service

For warranty service or repair, this product must be returned to a Stanford Research Systems authorized service facility. Contact Stanford Research Systems or an authorized representative before returning this product for repair.

Information in this document is subject to change without notice.

Copyright © Stanford Research Systems, Inc., 2006. All rights reserved.

Stanford Research Systems, Inc.
1290-D Reamwood Avenue
Sunnyvale, CA 94089 USA
Phone: (408) 744-9040 • Fax: (408) 744-9049
www.thinkSRS.com • e-mail: info@thinkSRS.com

Printed in U.S.A.



SIM964 Analog Limiter

Contents

General Information	iii
Safety and Preparation for Use	iii
Symbols	iv
Notation	v
Specifications	vi
1 Getting Started	1 – 1
1.1 Overview	1–2
1.2 Front-panel Operation	1–3
1.3 Clock Stopping	1–5
1.4 SIM Interface	1–6
2 Remote Operation	2 – 1
2.1 Index of Common Commands	2–2
2.2 Alphabetic List of Commands	2–4
2.3 Introduction	2–5
2.4 Commands	2–5
2.5 Status Model	2–15
3 Circuitry	3 – 1
3.1 Circuit Descriptions	3–2
3.2 Parts Lists	3–5
3.3 Schematic Diagrams	3–6

General Information

The SIM964 Analog Limiter, part of Stanford Research Systems' Small Instrumentation Modules family, is a low-noise programmable clamp for general signal conditioning from DC to 1 MHz. Upper and lower limits are independently settable between ± 10 V with 10 mV resolution. The clamped signal is available at the front-panel output, while rear-panel logic outputs indicate when either limit is exceeded.

Safety and Preparation for Use









The front-panel input, front-panel output, and the rear-panel output coaxial (BNC) connectors in the SIM964 are referenced to the Earth, and their outer casings are grounded. No dangerous voltages are generated by the module.

 **WARNING**

Do not exceed ± 15 volts to the Earth at the center terminal of any BNC connector. Do not install substitute parts or perform any unauthorized modifications to this instrument.

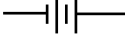
The SIM964 is a single-wide module designed to be used inside the SIM900 Mainframe. Do not turn on the power until the module is completely inserted into the mainframe and locked in place.

Symbols you may Find on SRS Products

Symbol	Description
	Alternating current
	Caution - risk of electric shock
	Frame or chassis terminal
	Caution - refer to accompanying documents
	Earth (ground) terminal
	Battery
	Fuse
	On (supply)
	Off (supply)

Notation



WARNING

The following notation will be used throughout this manual.

A warning means that injury or death is possible if the instructions are not obeyed.



CAUTION

A caution means that damage to the instrument or other equipment is possible.

Typesetting conventions used in this manual are:

- Front-panel buttons are set as [Button];
[Adjust ▲▼] is shorthand for “[Adjust ▲] & [Adjust ▼]”.
- Front-panel indicators are set as *Overload*.
- Remote command names are set as *IDN?.
- Literal text other than command names is set as OFF.

Remote command examples will all be set in monospaced font. In these examples, data sent by the host computer to the SIM964 are set as *straight teletype font*, while responses received by the host computer from the SIM964 are set as *slanted teletype font*.

Specifications

Performance Characteristics

Limit setting range	± 10 V
Resolution	10 mV
Bandwidth	1 MHz
Gain	1 \times
Input impedance	1 M Ω
Output noise	< 400 μ V rms
Total harmonic distortion	0.01 % (–80 dB) at 1 kHz
Slew rate	70 V/ μ s
Limit detection	TTL level outputs are LOW when corresponding limit (upper/lower) is exceeded.
Operating temperature	0 °C to 40 °C, non-condensing
Power	+5 V (50 mA typ., 100 mA max.) ± 15 V (50 mA typ., 300 mA max.)

General Characteristics

Interface	Serial (RS-232) through SIM interface
Connectors	BNC (2 front, 2 rear)
	DB-15 (male) SIM interface
Weight	1.5 lbs
Dimensions	1.5" W \times 3.6" H \times 7.0" D

1 Getting Started

This chapter gives you the necessary information to get started quickly with the SIM964 Analog Limiter.

In This Chapter

1.1	Overview	1-2
1.2	Front-panel Operation	1-3
1.2.1	Upper limit	1-3
1.2.2	Lower limit	1-3
1.2.3	Shortcuts	1-4
1.2.4	Input	1-4
1.2.5	Output	1-4
1.2.6	Rear panel outputs	1-4
1.3	Clock Stopping	1-5
1.4	SIM Interface	1-6
1.4.1	SIM interface connector	1-6
1.4.2	Direct interfacing	1-6

1.1 Overview

The SIM964 Analog Limiter is a digitally programmable signal limiter with a fully analog signal path. User-defined upper and lower voltage limits, in the range of ± 10 V, define a linear operating band for input signals from DC to 1 MHz.

The user can select an upper voltage limit, V_{UL} , and a lower voltage limit, V_{LL} , either remotely, or from the front panel. While the input signal, V_i , is within the range defined by the upper and lower limits, the SIM964 output, V_o , is a unity-gain buffered signal that follows the input signal. If the input signal exceeds one of the limits, the output of the SIM964 will be clamped to that limit for as long as the signal is in excess of the limit. When the input signal returns to the range between the limits, the output immediately recovers and follows the input signal again.

Mathematically, this can be expressed as

$$V_o = \begin{cases} V_{UL} & V_i > V_{UL} \\ V_i & V_{UL} \geq V_i \geq V_{LL} \\ V_{LL} & V_i < V_{LL} \end{cases}$$

The input and output signals are applied to the SIM964 through BNC connections on the front panel. Two TTL monitor outputs, corresponding to upper and lower limit saturation conditions, are provided through rear-panel BNC connections. The TTL output level is +5 V when the corresponding limit is *not* exceeded, and falls to 0 V for as long as the input is in excess of the limit.

1.2 Front-panel Operation

The front panel of the SIM964 (see Figure 1.1) provides a simple operator interface.



Figure 1.1: The SIM964 front and rear panels.

1.2.1 Upper limit

The [▲] and [▼] buttons on the left side of the front panel are associated with the upper numeric display to form the Upper Limit block. The numeric display indicates the value of V_{UL} (in volts), with 10 mV resolution.

Pressing [UL ▲] will raise the upper voltage limit, while [UL ▼] will lower it. Short presses of either key will step the limit in 10 mV increments; holding the key continuously will cause the limit setting to continuously change upwards or downwards at an accelerating rate.

The upper limit voltage V_{UL} can be set within the range:

$$+10\text{ V} \geq V_{UL} \geq (V_{LL} + 100\text{ mV})$$

1.2.2 Lower limit

The [▲] and [▼] buttons on the right side of the front panel are associated with the lower numeric display to form the Lower Limit block.

Operation is analogous to the Upper Limit block. Note, however, that pressing [LL ▲] will increase the signed value of V_{LL} (that is, make V_{LL} more positive); this acts to narrow the linear range of the SIM964, rather than expand it.

The lower limit voltage V_{LL} can be set within the range:

$$(V_{UL} - 100 \text{ mV}) \geq V_{LL} \geq -10 \text{ V}$$

1.2.3 Shortcuts

Pressing the two buttons [UL ▲▼] simultaneously will step the V_{UL} setting between +10 V, +5 V, 0 V, and -5 V (each successive two-button press steps to the next setting). This shortcut, however, cannot set $V_{UL} < (V_{LL} + 100 \text{ mV})$. Similarly, pressing the two buttons [LL ▲▼] simultaneously will step the V_{LL} setting between -10 V, -5 V, 0 V, and +5 V.

1.2.4 Input

The user signal, V_i , is input at the front-panel upper BNC connector, which presents a 1 M Ω input impedance.

1.2.5 Output

The analog output, V_o , is available at the front-panel lower BNC connector. Note that the SIM964 has a 50 Ω output impedance. When driving an external 50 Ω user load, this will result in the output signal being divided by 2.

1.2.6 Rear panel outputs

The two BNC connectors on the rear panel provide TTL monitor signals for the state of the SIM964 Analog Limiter. When the upper or lower limit is exceeded, the corresponding rear panel output is LOW (0 V); otherwise it idles HIGH (+5 V).

1.3 Clock Stopping

The microprocessor clock of the SIM964 stops if the module is idle, “freezing” the digital circuitry. The following actions “wake up” the clock:

1. A power-on.
2. A press of a front-panel button.
3. Activity (send or receive) at the remote interface.
4. An input overload.
5. An upper or lower limit clamp.

The clock runs for as long as is necessary to complete a limit setting adjustment, or to communicate the output of a query through the remote interface. However, the clock will remain active for as long as the overload or limit condition exists.

This default behavior can be modified with the remote command *AWAK*. Setting *AWAK ON* will prevent the clock from stopping. The module returns to *AWAK OFF* upon power-on.

1.4 SIM Interface

The primary connection to the SIM964 Analog Limiter is the rear-panel DB-15 SIM interface connector. Typically, the SIM964 is mated to a SIM900 Mainframe via this connection, either through one of the internal Mainframe slots, or the remote cable interface.

It is also possible to operate the SIM964 directly, without using the SIM900 Mainframe. This section provides details on the interface.



CAUTION

The SIM964 has no internal protection against reverse polarity, missing supply, or overvoltage on the power supply pins. Misapplication of power may cause circuit damage. SRS recommends using the SIM964 together with the SIM900 Mainframe for most applications.

1.4.1 SIM interface connector

The DB-15 SIM interface connector carries all the power and communications lines to the instrument. The connector signals are specified in Table 1.1

Pin	Signal	Direction Src ⇒ Dest	Description
1	SIGNAL_GND	MF ⇒ SIM	Ground reference for signal
2	-STATUS	SIM ⇒ MF	Status/service request (GND = asserted, +5 V = idle)
3	RTS	MF ⇒ SIM	HW handshake (unused in SIM964)
4	CTS	SIM ⇒ MF	HW handshake (unused in SIM964)
5	-REF_10MHZ	MF ⇒ SIM	10 MHz reference (no connection in SIM964)
6	-5 V	MF ⇒ SIM	Power supply (no connection in SIM964)
7	-15 V	MF ⇒ SIM	Power supply
8	PS_RTN	MF ⇒ SIM	Power supply return
9	CHASSIS_GND		Chassis ground
10	TXD	MF ⇒ SIM	Async data (start bit = "0" = +5 V; "1" = GND)
11	RXD	SIM ⇒ MF	Async data (start bit = "0" = +5 V; "1" = GND)
12	+REF_10MHz	MF ⇒ SIM	10 MHz reference (no connection in SIM964)
13	+5 V	MF ⇒ SIM	Power supply
14	+15 V	MF ⇒ SIM	Power supply
15	+24 V	MF ⇒ SIM	Power supply (no connection in SIM964)

Table 1.1: SIM Interface Connector Pin Assignments, DB-15

1.4.2 Direct interfacing

The SIM964 is intended for operation in the SIM900 Mainframe, but users may wish to directly interface the module to their own systems without the use of additional hardware.

The mating connector needed is a standard DB-15 receptacle, such as Amp part # 747909-2 (or equivalent). Clean, well-regulated supply voltages of $\pm 15, +5$ VDC must be provided, following the pin-out specified in Table 1.1. Ground must be provided on pins 1 and 8, with chassis ground on pin 9. The -STATUS signal may be monitored on pin 2 for a low-going TTL-compatible output indicating a status message.

1.4.2.1 Direct interface cabling

If the user intends to directly wire the SIM964 independent of the SIM900 Mainframe, communication is usually possible by directly connecting the appropriate interface lines from the SIM964 DB-15 plug to the RS-232 serial port of a personal computer.¹ Connect RXD from the SIM964 directly to RD on the PC, TXD directly to TD. In other words, a null-modem style cable is *not* needed.

To interface directly to the DB-9 male (DTE) RS-232 port typically found on contemporary personal computers, a cable must be made with a female DB-15 socket to mate with the SIM964, and a female DB-9 socket to mate with the PC's serial port. Separate leads from the DB-15 need to go to the power supply, making what is sometimes know as a "hydra" cable. The pin-connections are given in Table 1.2.

DB-15/F to SIM964	Name
	DB-9/F
10 \longleftrightarrow 3	TxD
11 \longleftrightarrow 2	RxD
5	Computer Ground
	to P/S
7 \longleftrightarrow -15 VDC	
13 \longleftrightarrow +5 VDC	
14 \longleftrightarrow +15 VDC	
8,9 \longleftrightarrow Ground (P/S return current)	
1 \longleftrightarrow Signal Ground (separate wire to Ground)	

Table 1.2: SIM964 Direct Interface Cable Pin Assignments

¹ Although the serial interface lines on the DB-15 do not satisfy the minimum voltage levels of the RS-232 standard, they are typically compatible with desktop personal computers

1.4.2.2 Serial settings

The initial serial port settings at power-on are: 9600 Baud, 8–bits, no parity, 1 stop bit, and no flow control. The serial baud rate is fixed, but the parity may be changed with the **PARI** commands.

2 Remote Operation

This chapter describes operating the SIM964 over the serial interface.

In This Chapter

2.1	Index of Common Commands	2-2
2.2	Alphabetic List of Commands	2-4
2.3	Introduction	2-5
2.3.1	Power-on configuration	2-5
2.3.2	Buffers	2-5
2.3.3	Device Clear	2-5
2.4	Commands	2-5
2.4.1	Command Syntax	2-6
2.4.2	Notation	2-7
2.4.3	Examples	2-7
2.4.4	Configuration Commands	2-8
2.4.5	Monitor Commands	2-9
2.4.6	Serial Communication Commands	2-9
2.4.7	Status Commands	2-10
2.4.8	Interface Commands	2-11
2.5	Status Model	2-15
2.5.1	Status Byte (SB)	2-16
2.5.2	Service Request Enable (SRE)	2-17
2.5.3	Standard Event Status (ESR)	2-17
2.5.4	Standard Event Status Enable (ESE)	2-18
2.5.5	Communication Error Status (CESR)	2-18
2.5.6	Communication Error Status Enable (CESE)	2-19

2.1 Index of Common Commands

symbol	definition
<i>i,j</i>	Integers
<i>f</i>	Floating-point values
<i>z</i>	Literal token
(?)	Required for queries; illegal for set commands
<i>var</i>	parameter always required
{ <i>var</i> }	required parameter for set commands; illegal for queries
[<i>var</i>]	optional parameter for both set and query forms

Configuration

ULIM(?) { <i>f</i> }	2 – 8	Upper Limit
LLIM(?) { <i>f</i> }	2 – 8	Lower Limit
AWAK(?) { <i>z</i> }	2 – 8	Keep Clock Awake

Monitor

ULCR?	2 – 9	Upper Limit Condition
LLCR?	2 – 9	Lower Limit Condition
OVLDD?	2 – 9	Overload Condition

Serial Communications

PARI(?) { <i>z</i> }	2 – 9	Parity
----------------------	-------	--------

Status

*STB? [<i>i</i>]	2 – 10	Status Byte
*SRE(?) [<i>i</i> ,] { <i>j</i> }	2 – 10	Service Request Enable
*CLS	2 – 10	Clear Status
*ESR? [<i>i</i>]	2 – 10	Standard Event Status
*ESE(?) [<i>i</i> ,] { <i>j</i> }	2 – 10	Standard Event Status Enable
CESR? [<i>i</i>]	2 – 11	Comm Error Status
CESE(?) [<i>i</i> ,] { <i>j</i> }	2 – 11	Comm Error Status Enable
PSTA(?) { <i>z</i> }	2 – 11	Pulse –STATUS Mode

Interface

*RST	2 – 11	Reset
*IDN?	2 – 12	Identify
*OPC(?)	2 – 12	Operation Complete
CONS(?) { <i>z</i> }	2 – 12	Console Mode
LEXE?	2 – 12	Execution Error
LCME?	2 – 13	Command Error
LBTN?	2 – 13	Button
TOKN(?) { <i>z</i> }	2 – 14	Token Mode
TERM(?) { <i>z</i> }	2 – 14	Response Termination

2.2 Alphabetic List of Commands

★

*CLS	2-10	Clear Status
*ESE(?) [i,] {j}	2-10	Standard Event Status Enable
*ESR? [i]	2-10	Standard Event Status
*IDN?	2-12	Identify
*OPC(?)	2-12	Operation Complete
*RST	2-11	Reset
*SRE(?) [i,] {j}	2-10	Service Request Enable
*STB? [i]	2-10	Status Byte

A

AWAK(?) {z}	2-8	Keep Clock Awake
-------------	-----	------------------

C

CESE(?) [i,]{j}	2-11	Comm Error Status Enable
CESR? [i]	2-11	Comm Error Status
CONS(?) {z}	2-12	Console Mode

L

LBTN?	2-13	Button
LCME?	2-13	Command Error
LEXE?	2-12	Execution Error
LLCR?	2-9	Lower Limit Condition
LLIM(?) {f}	2-8	Lower Limit

O

OVLD?	2-9	Overload Condition
-------	-----	--------------------

P

PARI(?) {z}	2-9	Parity
PSTA(?) {z}	2-11	Pulse -STATUS Mode

T

TERM(?) {z}	2-14	Response Termination
TOKN(?) {z}	2-14	Token Mode

U

ULCR?	2-9	Upper Limit Condition
ULIM(?) {f}	2-8	Upper Limit

2.3 Introduction

Remote operation of the SIM964 is through a simple command language documented in this chapter. Both set and query forms of most commands are supported, allowing the user complete control of the analog limiter from a remote computer, either through the SIM900 Mainframe or directly via RS-232 (see Section 1.4.2.1).

See Table 1.1 for specification of the DB-15 SIM interface connector.

2.3.1 Power-on configuration

The settings for the remote interface are 9600 baud with no parity or flow control, and local echo disabled (**CONS OFF**).

Most of the SIM964 instrument settings are stored in non-volatile memory, and at power-on the instrument returns to the state it was last in when power was removed. Exceptions are noted in the command descriptions.

Reset values of parameters are shown in **boldface**.

2.3.2 Buffers

Incoming data from the host interface is stored in a 64-byte input buffer. Characters accumulate in the input buffer until a command terminator (either **<CR>** or **<LF>**) is received, at which point the message is parsed and executed. Query responses from the SIM964 are buffered in a 64-byte output queue.

If the input buffer overflows, then all data in *both* the input buffer and the output queue are discarded, and an error is recorded in the CESR and ESR status registers.

2.3.3 Device Clear

The SIM964 host interface can be asynchronously reset to its power-on configuration by sending an RS-232-style **<break>** signal. From the SIM900 Mainframe, this is accomplished with the SIM900 **SRST** command; if directly interfacing via RS-232, then use a serial break signal. After receiving the Device Clear, the interface is reset to 9600 baud and **CONS** mode is turned **OFF**. Note that this *only* resets the communication interface; the basic function of the SIM964 is left unchanged; to reset the instrument, see ***RST**.

2.4 Commands

This section provides syntax and operational descriptions for remote commands.

2.4.1 Command Syntax

The four letter mnemonic (shown in **CAPS**) in each command sequence specifies the command. The rest of the sequence consists of parameters.

Commands may take either *set* or *query* form, depending on whether the “?” character follows the mnemonic. *Set only* commands are listed without the “?”, *query only* commands show the “?” after the mnemonic, and *optionally query* commands are marked with a “(?)”.

Parameters shown in { } and [] are not always required. Parameters in { } are required to set a value, and are omitted for queries. Parameters in [] are optional in both set and query commands. Parameters listed without any surrounding characters are always required.

Do *not* send () or { } or [] as part of the command.

Multiple parameters are separated by commas. Multiple commands may be sent on one command line by separating them with semicolons (;) so long as the input buffer does not overflow. Commands are terminated by either <CR> or <LF> characters. Null commands and whitespace are ignored. Execution of command(s) does not begin until the command terminator is received.

tokens Token parameters (generically shown as *z* in the command descriptions) can be specified either as a keyword or integer value. Command descriptions list the valid keyword options, with each keyword followed by its corresponding integer value. For example, to set the response termination sequence to <CR>+<LF>, the following two commands are equivalent:

TERM CRLF —or— TERM 3

For queries that return token values, the return format (keyword or integer) is specified with the **TOKN** command.

2.4.2 Notation

The following table summarizes the notation used in the command descriptions:

symbol	definition
<i>i,j</i>	Integers
<i>f</i>	Floating-point values
<i>z</i>	Literal token
(?)	Required for queries; illegal for set commands
<i>var</i>	parameter always required
{ <i>var</i> }	required parameter for set commands; illegal for queries
[<i>var</i>]	optional parameter for both set and query forms

2.4.3 Examples

Each command is provided with a simple example illustrating its usage. In these examples, all data sent by the host computer to the SIM964 are set as *straight teletype font*, while responses received the host computer from the SIM964 are set as *slanted teletype font*.

The usage examples vary with respect to set/query, optional parameters, and token formats. These examples are not exhaustive, but are intended to provide a convenient starting point for user programming.

2.4.4 Configuration Commands

ULIM(?) {f} Upper Limit

Set (query) the upper limit voltage V_{UL} {to *f*}, in volts.

If ULIM is set outside the range

$$+10\text{ V} \geq V_{UL} \geq V_{LL} + 100\text{ mV},$$

then the command will fail, setting the EXE bit in the *ESR register, and setting the LEXE parameter to “invalid parameter” (16).

Example: ULIM 3.14
 ULIM?
 +3.14

LLIM(?) {f} Lower Limit

Set (query) the lower limit voltage V_{LL} {to *f*}, in volts.

If LLIM is set outside the range

$$V_{UL} - 100\text{ mV} \geq V_{LL} \geq -10\text{ V},$$

then the command will fail, setting the EXE bit in the *ESR register, and setting the LEXE parameter to “invalid parameter” (16).

Example: LLIM -8.042
 LLIM?
 -8.04

AWAK(?) {z} Keep Clock Awake

Set (query) the SIM964 keep-awake mode {to *z* = (OFF 0, ON 1)}.

Ordinarily, the clock oscillator for the SIM964 microcontroller is held in a stopped state, and only enabled during processing of events (Section 1.3). Setting AWAK ON forces the clock to stay running, and is useful only for diagnostic purposes.

Example: AWAK ON

2.4.5 Monitor Commands

ULCR?	<p>Upper Limit Condition</p> <p>Query the upper limit detector. Returns 1 if input signal exceeds the upper limit voltage, $V_i > V_{UL}$. Returns 0 otherwise.</p> <p>ULCR? returns the complement of the rear-panel output; ULCR? returns 1 when the Upper Limit Detect output is LOW, and 0 when HIGH.</p> <p><i>Example:</i> ULCR? 0</p>
<hr/>	
LLCR?	<p>Lower Limit Condition</p> <p>Query the lower limit detector. Returns 1 if input signal exceeds the lower limit voltage, $V_i < V_{LL}$. Returns 0 otherwise.</p> <p>LLCR? returns the complement of the rear-panel output; LLCR? returns 1 when the Lower Limit Detect output is LOW, and 0 when HIGH.</p> <p><i>Example:</i> LLCR? 1</p>
<hr/>	
OVLD?	<p>Overload Condition</p> <p>Query the input overload detector. Returns 1 if the input is overloaded, or 0 otherwise.</p> <p><i>Example:</i> OVLD? 0</p>

2.4.6 Serial Communication Commands

PARI(?) {z}	<p>Parity</p> <p>Set (query) parity {to z = (NONE 0, ODD 1, EVEN 2, MARK 3, SPACE 4)}.</p> <p>After power-on, modules default to PARI NONE.</p> <p><i>Example:</i> PARI EVEN</p>
-------------	--

2.4.7 Status Commands

The Status commands query and configure registers associated with status reporting of the SIM964.

*STB? [i]	<p>Status Byte</p> <p>Reads the Status Byte register [bit <i>i</i>].</p> <p>Execution of the *STB? query (without the optional bit <i>i</i>) always causes the –STATUS signal to be deasserted. Note that *STB? <i>i</i> will <i>not</i> clear –STATUS, even if bit <i>i</i> is the only bit presently causing the –STATUS signal. See also the PSTA command.</p> <p><i>Example:</i> *STB? 16</p>
*SRE(?) [i,] {j}	<p>Service Request Enable</p> <p>Set (query) the Service Request Enable register [bit <i>i</i>] {to <i>j</i>}.</p> <p><i>Example:</i> *SRE 0,1</p>
*CLS	<p>Clear Status</p> <p>*CLS immediately clears the ESR and CESR status registers.</p> <p><i>Example:</i> *CLS</p>
*ESR? [i]	<p>Standard Event Status</p> <p>Reads the Standard Event Status Register [bit <i>i</i>].</p> <p>Upon executing *ESR?, the returned bit(s) of the ESR register are cleared.</p> <p><i>Example:</i> *ESR? 64</p>
*ESE(?) [i,] {j}	<p>Standard Event Status Enable</p> <p>Set (query) the Standard Event Status Enable Register [bit <i>i</i>] {to <i>j</i>}.</p> <p><i>Example:</i> *ESE 6,1 ESE? 64</p>

CESR? [i]	<p>Comm Error Status</p> <p>Query Comm Error Status Register [for bit <i>i</i>].</p> <p>Upon executing a CESR? query, the returned bit(s) of the CESR register are cleared.</p> <p><i>Example:</i> CESR? 0</p>
<hr/>	
CESE(?) [i],[j]	<p>Comm Error Status Enable</p> <p>Set (query) Comm Error Status Enable Register [for bit <i>i</i>] {to <i>j</i>}</p> <p><i>Example:</i> CESE? 0</p>
<hr/>	
PSTA(?) {z}	<p>Pulse –STATUS Mode</p> <p>Set (query) the Pulse –STATUS Mode {to <i>z</i>=(OFF 0, ON 1)}.</p> <p>When PSTA ON is set, any new service request will only <i>pulse</i> the –STATUS signal low (for a minimum of 1 μs). The default behavior is to latch –STATUS low until a *STB? query is received.</p> <p>At power-on, PSTA is set to OFF.</p> <p><i>Example:</i> PSTA? OFF</p>

2.4.8 Interface Commands

Interface commands provide generic control over the interface between the SIM964 and the host computer.

*RST	<p>Reset</p> <p>Reset the SIM964 to default configuration.</p> <p>The following commands are internally executed upon *RST:</p> <ul style="list-style-type: none"> • ULIM +10.00 • LLIM -10.00 • AWAK OFF <p><i>Example:</i> *RST</p>
------	--

*IDN?	<p>Identify</p> <p>Read the device identification string.</p> <p>The identification string is formatted as: Stanford_Research_Systems,SIM964,s/n*****,ver#.# where ***** is the 6-digit serial number, and #.# is the firmware revision level.</p> <p><i>Example:</i> *IDN? Stanford_Research_Systems,SIM964,s/n003075,ver1.0</p>														
<hr/>															
*OPC(?)	<p>Operation Complete</p> <p>Operation Complete. Sets the OPC flag in the ESR register.</p> <p>The query form *OPC? writes a 1 in the output queue when complete, but does not affect the ESR register.</p> <p><i>Example:</i> *OPC</p>														
<hr/>															
CONS(?) {z}	<p>Console Mode</p> <p>Set (query) the Console mode {to z=(OFF 0, ON 1)}.</p> <p>CONS causes each character received at the Input Buffer to be copied to the Output Queue.</p> <p>At power-on and Device-Clear, CONS is set to OFF.</p> <p><i>Example:</i> CONS? 0</p>														
<hr/>															
LEXE?	<p>Execution Error</p> <p>Query the last execution error code. A query of LEXE? always clears the error code, so a subsequent LEXE? will return 0. Valid codes are:</p> <table border="1" style="margin-left: 40px; border-collapse: collapse;"> <thead> <tr> <th style="text-align: left; padding: 2px;">Value</th> <th style="text-align: left; padding: 2px;">Definition</th> </tr> </thead> <tbody> <tr> <td style="text-align: center; padding: 2px;">0</td> <td style="padding: 2px;">No execution error since last LEXE?</td> </tr> <tr> <td style="text-align: center; padding: 2px;">1</td> <td style="padding: 2px;">Illegal value</td> </tr> <tr> <td style="text-align: center; padding: 2px;">2</td> <td style="padding: 2px;">Wrong token</td> </tr> <tr> <td style="text-align: center; padding: 2px;">3</td> <td style="padding: 2px;">Invalid bit</td> </tr> <tr> <td style="text-align: center; padding: 2px;">16</td> <td style="padding: 2px;">Invalid parameter</td> </tr> <tr> <td style="text-align: center; padding: 2px;">18</td> <td style="padding: 2px;">No change</td> </tr> </tbody> </table> <p><i>Example:</i> *STB? 12; LEXE?; LEXE? 3 0</p> <p>The error (3, "Invalid bit,") is because *STB? only allows bit-specific queries of 0–7. The second LEXE? returns 0.</p>	Value	Definition	0	No execution error since last LEXE?	1	Illegal value	2	Wrong token	3	Invalid bit	16	Invalid parameter	18	No change
Value	Definition														
0	No execution error since last LEXE?														
1	Illegal value														
2	Wrong token														
3	Invalid bit														
16	Invalid parameter														
18	No change														

LCME?**Command Error**

Query the last command error code. A query of LCME? always clears the error code, so a subsequent LCME? will return 0. Valid codes are:

Value	Definition
0	No execution error since last LCME?
1	Illegal command
2	Undefined command
3	Illegal query
4	Illegal set
5	Missing parameter(s)
6	Extra parameter(s)
7	Null parameter(s)
8	Parameter buffer overflow
9	Bad floating-point
10	Bad integer
11	Bad integer token
12	Bad token value
13	Bad hex block
14	Unknown token

Example: *IDN
LCME?
4
The error (4, "Illegal set") is due to the missing "?".

LBTN?**Button**

Query the last button-press code. A query of LBTN? always clears the button code, so a subsequent LBTN? will return 0. Valid codes are:

Value	Definition
0	no button pressed since last LBTN?
1	[UL ▲]
2	[UL ▼]
3	[LL ▲]
4	[LL ▼]
5	[UL ▲▼]
6	[LL ▲▼]

Example: LBTN?
1

TOKN(?) {z}

Token Mode

Set (query) the Token Query mode {to z=(**OFF 0**, **ON 1**)}.

If TOKN ON is set, then queries to the SIM module that return tokens will return the text keyword; otherwise they return the decimal integer value.

Thus, the only possible responses to the TOKN? query are ON and 0.

On reset, TOKN is set to OFF.

Example: TOKN OFF

TERM(?) {z}

Response Termination

Set (query) the <term> sequence {to z=(**NONE 0**, **CR 1**, **LF 2**, **CRLF 3**, **LFCR 4**)}. The <term> sequence is appended to all query responses sent by the module, and is constructed of ASCII character(s) 13 (carriage return) and 10 (line feed). The token mnemonic gives the sequence of characters.

At power-on, TERM is set to CRLF.

Example: TERM?
3

2.5 Status Model

The SIM964 status registers follow the hierarchical IEEE–488.2 format. A block diagram of the status register array is given in Figure 2.1.

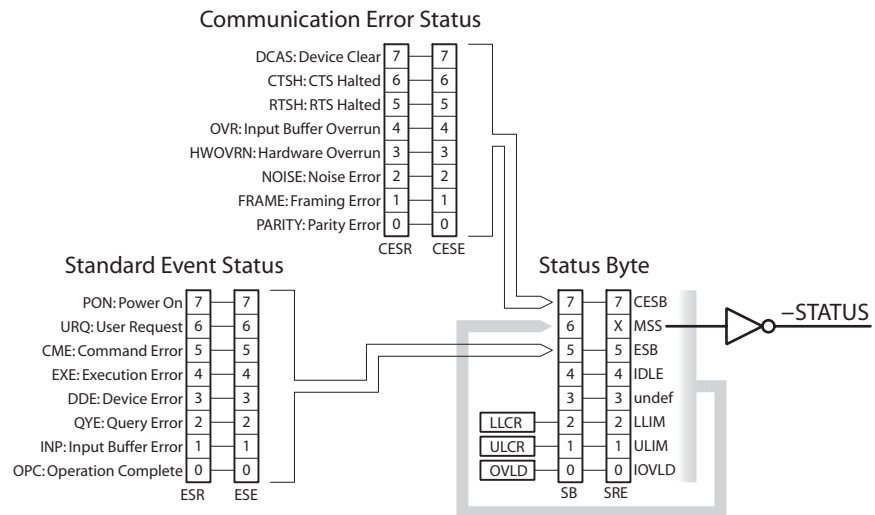

Figure 2.1: Status Register Model for the SIM964.

There are three categories of registers in the SIM964 status model:

- Condition Registers :** These read-only registers correspond to the real-time condition of some underlying physical property being monitored. Queries return the latest value of the property, and have no other effect. Condition register names typically end with CR (OVLD being an exception).
- Event Registers :** These read-only registers record the occurrence of defined events. When the event occurs, the corresponding bit is set to 1. Upon querying an event register, any set bits within it are cleared. These are sometimes known as “sticky bits,” since once set, a bit can only be cleared by reading its value. Event register names end with SR.
- Enable Registers :** These read/write registers define a bitwise mask for their corresponding event register. If any bit position is set in an event register while the same bit position is also set in the enable register, then the corresponding summary bit message is set. Enable register names end with SE.

2.5.1 Status Byte (SB)

The Status Byte is the top-level summary of the SIM964 status model. When masked by the Service Request Enable register, a bit set in the Status Byte causes the $\overline{\text{STATUS}}$ signal to be asserted on the rear-panel SIM interface connector.

Typically, $\overline{\text{STATUS}}$ remains asserted (low) until a *STB? query is received, at which time $\overline{\text{STATUS}}$ is deasserted (raised)¹. After clearing the $\overline{\text{STATUS}}$ signal, it will only be re-asserted in response to a *new* status-generating condition.

Weight	Bit	Flag
1	0	IOVLD
2	1	ULIM
4	2	LLIM (0)
8	3	undef (0)
16	4	IDLE
32	5	ESB
64	6	MSS
128	7	CESB

IOVLD : Overload Event. Indicates the input overload detector has been triggered. This corresponds to a $0 \rightarrow 1$ transition on OVLD).

ULIM : Upper Limit Event. Indicates the upper limit clamp has been activated. This corresponds to a $0 \rightarrow 1$ transition on ULCR.

LLIM : Lower Limit Event. Indicates the lower limit clamp has been activated. This corresponds to a $0 \rightarrow 1$ transition on LLCR.

IDLE : Indicates that the Input Buffer is empty and the command parser is idle. Can be used to help synchronize SIM964 query responses.

ESB : Event Status Bit. Indicates whether one or more of the enabled events in the Standard Event Status Register is true.

MSS : Master Summary Status. Indicates whether one or more of the enabled status messages in the Status Byte register is true. Note that while $\overline{\text{STATUS}}$ is released by the *STB? query, MSS is only cleared when the underlying enabled bit message(s) are cleared.

CESB : Communication Error Summary Bit. Indicates whether one or more of the enabled flags in the Communication Error Status Register has become true.

The IOVLD, ULIM, and LLIM bits are “true” event status bits, and after being set by their corresponding events, the “1” value persists

¹ but see the PSTA command

until read by the *STB? query. After a *STB? query, the IOVLD, ULIM, and LLIM bits are cleared to “0”, and can only be set back to 1 by a *new* event.

The remaining bits in the Status Byte are *not* cleared by the *STB? query. These bits are only cleared by reading the underlying event registers, or by clearing the corresponding enable registers.

2.5.2 Service Request Enable (SRE)

Each bit in the SRE corresponds one-to-one with a bit in the SB register, and acts as a bitwise AND of the SB flags to generate the MSS bit in the SB and the –STATUS signal. Bit 6 of the SRE is undefined—setting it has no effect, and reading it always returns 0. This register is set and queried with the *SRE(?) command.

This register is cleared at power-on.

2.5.3 Standard Event Status (ESR)

The Standard Event Status register consists of 8 event flags. These event flags are all “sticky bits” that are set by the corresponding event, and cleared only by reading or with the *CLS command. Reading a single bit (with the *ESR? *i* query) clears only bit *i*.

Weight	Bit	Flag
1	0	OPC
2	1	INP
4	2	QYE
8	3	DDE
16	4	EXE
32	5	CME
64	6	URQ
128	7	PON

OPC : Operation Complete. Set by the *OPC command.

INP : Input Buffer Error. Indicates data has been discarded from the Input Buffer.

QYE : Query Error. Indicates data in the Output Queue has been lost.

DDE : Device Dependent Error. Indicates a SIM964 had a delayed execution error, due to an illegal mode state. The error code can be queried with LDDE?.

EXE : Execution Error. Indicates an error in a command that was successfully parsed. Out-of-range parameters are an example. The error code can be queried with LEXE?.

CME : Command Error. Indicates a parser-detected error. The error code can be queried with LCME?.

URQ : User Request. Indicates a front-panel button was pressed.

PON : Power On. Indicates that an off-to-on transition has occurred

2.5.4 Standard Event Status Enable (ESE)

The ESE acts as a bitwise AND with the ESR register to produce the single bit ESB message in the Status Byte Register (SB). It can be set and queried with the *ESE(?) command.

This register is cleared at power-on.

2.5.5 Communication Error Status (CESR)

The Communication Error Status register consists of 8 event flags; each of which is set by the corresponding event, and cleared only by reading or with the *CLS command. Reading a single bit (with the CESR? *i* query) clears only bit *i*.

Weight	Bit	Flag
1	0	PARITY
2	1	FRAME
4	2	NOISE
8	3	HWOVRN
16	4	OVR
32	5	RTSH
64	6	CTSH
128	7	DCAS

PARITY : Parity Error. Set by serial parity mismatch on incoming data byte.

FRAME : Framing Error. Set when an incoming serial data byte is missing the STOP bit.

NOISE : Noise Error. Set when an incoming serial data byte does not present a steady logic level during each asynchronous bit-period window.

HWOVRN : Hardware Overrun. Set when an incoming serial data byte is lost due to internal processor latency. Causes the Input Buffer to be flushed, and resets the command parser.

OVR : Input Buffer Overrun. Set when the Input Buffer is overrun by incoming data. Causes the Input Buffer to be flushed, and resets the command parser.

RTSH : RTS Holdoff Event. Not implemented in the SIM964.

CTSH : CTS Holdoff Event. Not implemented in the SIM964.

DCAS : Device Clear. Indicates the SIM964 received the Device Clear signal (an RS-232 <break>). Clears the Input Buffer and Output Queue, and resets the command parser.

2.5.6 Communication Error Status Enable (CESE)

The CESE acts as a bitwise AND with the CESR register to produce the single bit CESB message in the Status Byte Register (SB). It can be set and queried with the CESE(?) command.

This register is cleared at power-on.

3 Parts Lists and Schematics

This chapter presents a brief description of the SIM964 circuit design. A complete parts list and circuit schematics are included.

In This Chapter

3.1	Circuit Descriptions	3-2
3.1.1	Microcontroller	3-2
3.1.2	Front Panel Display	3-2
3.1.3	Input Overload Detection	3-3
3.1.4	Limit Levels	3-3
3.1.5	Limiting Circuitry	3-3
3.1.6	Output Circuit	3-4
3.2	Parts Lists	3-5
3.3	Schematic Diagrams	3-6

3.1 Circuit Descriptions

The SIM964 consists of two separate printed circuit boards: the main board, and the front-panel board.

3.1.1 Microcontroller

The SIM964 is controlled by microcontroller U103. The controller is clocked at 5 MHz.

A critical aspect of the design is the clock-stop circuitry implemented by U111 and U102. A simple RC-oscillator is enabled or disabled at pin 1 of U102, which is driven by synchronizing flip-flop U111B to ensure that no “runt” clock pulses are produced that would violate U103’s minimum clock periods. Four separate clock-starting signals are diode-or’d by D103, D104, D105, and D106:

- Power-on reset (–RESET)
- Overload (–OVERLOAD)
- Incoming serial data (–TXD)
- Front-panel button press (–BTN.PRESS.*n*)

The fast start-time of the RC-oscillator ensures that incoming serial data will be correctly decoded by the microcontroller’s UART, even when the clock is started by the serial start bit of the incoming data. When the microcontroller has completed all pending activity, it drives the STOP signal high (pin 36 of U103), effectively halting its own processor clock. In this way, the SIM964 guarantees no digital clock artifacts can be generated during quiescent operation.

The fast start-time of the RC-oscillator ensures that incoming serial data will be correctly decoded by the microcontroller’s UART, even when the clock is started by the serial start bit of the incoming data. When the microcontroller has completed all pending activity, it drives the STOP signal high (pin 8 of U104), effectively halting its own processor clock. In this way, the SIM964 guarantees no digital clock artifacts can be generated during quiescent operation.

3.1.2 Front Panel Display

The seven segment displays and LED lamps on the front panel are powered by U401–U407, a daisy-chain of 74HC595 serial input shift registers. The currents to the lamps are limited by resistor networks in series with the displays and LEDs. The displays and LEDs are all statically driven (i.e., *not* multiplexed).

3.1.3 Input Overload Detection

Input overload is detected via dual comparator U201 with a wire-or output arrangement that is level shifted using Q201 and Q202. This signal is input to the controller.

3.1.4 Limit Levels

The upper and lower limits are generated using two 12-bit multiplying DACs with level shifting op-amps. A 10 V reference signal from U205, which can be trimmed with R207, is input to the DACs and the range of the resulting limit voltages is ± 10 V.

3.1.5 Limiting Circuitry

The limiter consists of two cascaded clamping circuits. Each clamping circuit consists of two operational amplifiers in a feedback arrangement that allows their outputs to flip between two stable states depending on whether the input signal is above or below the limit voltage.

Consider the operation of the clamping circuit for the upper limit. Op-amp U303 has diode D312 at its output. The diode is in the (DC) feedback loop of this amplifier, so depending on the polarity of the difference of the amplifier inputs, the output will either turn the diode on (into forward conduction) or off.

When diode D312 is on, the amplifier output acts as a current sink for the resistor combination R302/R304. This effectively clamps the output of the resistor combination to whatever the potential is at the noninverting input of U303. U305 is a current feedback amplifier whose output, in this limiting situation, will attempt to rise above the upper limit voltage, causing diode D311 to be reverse-biased. This means that the noninverting input of U303 will remain at the upper limit voltage, so the output of R302/R304 will also remain at the upper limit voltage.

If the input signal (U301s output) drops below the upper limit voltage, the noninverting input of U305 will also be lower than the upper limit, so the output of U305 will swing negative and eventually forward bias diode D311. Now current flows through R322/R324 and D311, so that the noninverting input to U303 is no longer pinned to the upper limit voltage. Now diode D312 becomes reverse biased, so that current from R302/R304 no longer has a sink at U303s output. When this happens, the feedback path from U303s output, through U305, and back to U303s noninverting input, stably holds U303s output about one diode drop above the upper limit.

The advantage of this (somewhat complicated) feedback path is that it keeps U303s output from saturating when the input signal is below the upper limit and D312 is reverse biased. When D312 becomes reverse biased, the local feedback path for U303 around R320 breaks, and would run away to the rails were it not for the new feedback path through U305 that turns on when D311 becomes forward biased. This is important, because when the input signal rises above the upper limit, U303s output can respond much more rapidly to turn on D312, since it does not first have to recover from positive output saturation. In normal operation, the output of U303 flips between being about one diode drop above or below the upper limit, depending on whether the input signal is below or above, respectively, the upper limit. The transition between either state is rapid but smooth, so the node at U303s output is used by the differential amplifier circuit of U308, along with the upper limit voltage to generate a TTL signal that indicates whether the input signal is above or below the upper limit.

The signal output from the R302/R304 combination is buffered by the follower U302 before passing to a nearly identical lower limit clamping circuit as the one for the upper limit. The only differences between the two are the orientation of the two diodes, and the orientation of the inputs to the differential amplifier U310. The output of the R303/R305 combination is then buffered by U302 before passing to the output circuitry.

3.1.6 Output Circuit

The output signal is low-pass RC filtered with a -3 dB frequency of 10 MHz by R612 and C602. U601 and U602 form a composite amplifier for the output driver. This arrangement provides the driving capability of the BUF634 without suffering its large input offset voltage, since the output of U602 is servoed to the noninverting input of U601 via the feedback resistor R605.

A $49.9\ \Omega$ resistor (R604) is in series with the output.

3.2 Parts Lists

Reference	SRS P/N	Value	Reference	SRS P/N	Value
C101	5-00381	330P	R201	4-01496	5.1K
C102	5-00104	3.5-20P	R202,R203,R206,R210,R310, R311,R312,R313,R316,R317, R318,R319	4-01213	10.0K
C105,C109,C111,C113,C114, C115,C119,C120,C121,C122, C123,C124,C125,C126,C202, C205,C206,C207,C208,C209, C210,C211,C212,C213,C305, C306,C307,C308,C309,C310, C311,C312,C313,C314,C315, C316,C319,C320,C323,C324, C401,C402,C403,C404,C405, C406,C407,C605,C606,C607, C608	5-00299	.1U	R204,R208,R211,R214	4-01242	20.0K
C106,C107,C108,C110,C112	5-00102	4.7U	R205,R209	4-01243	20.5K
C116,C117,C118	5-00387	1000P	R207	4-00011	10K
C201,C204	5-00369	33P	R212,R213	4-01280	49.9K
C203	5-00542	1.0U	R301	4-01405	1.00M
C302,C301	5-00313	1P	R302,R303,R304,R305,R322, R323,R324,R325	4-01146	2.00K
C331,C332,C609	5-00367	22P	R306	4-01021	100
C334,C333	5-00557	18P	R321,R320	4-01050	200
C602	5-00372	56P	R326	4-01038	150
D101	3-00945	BAT54S	R327,R328,R334,R335,R336, R337,R338,R341,R345,R346, R347,R352	4-01117	1.00K
D103,D104,D105,D106	3-00901	BAS40-06	R330,R343	4-01163	3.01K
D307,D308,D309,D310	3-01243	BAS40-04	R331,R332,R340,R350	4-01088	499
D311,D312,D313,D314	3-00004	1N4148	R333,R339,R344,R349	4-01230	15.0K
D501,D502	3-00424	GREEN	R342,R351	4-01105	750
D503	3-00425	RED	R401	4-01479	1.0K
JP101	1-00302	6 PIN DIF CES	R402,R403,R501,R502	4-01489	2.7K
JP103	1-00367	15 PIN D	R404,R405,R406	4-01487	2.2K
J101,J102,J301,J601	1-00003	BNC	R604	4-00913	49.9 FP
J401	1-01076	56 PIN DRA	R605	4-01104	732
J501	1-01077	56 PIN DRA	R612	4-01065	287
L101,L102,L103,L104,L105	6-00174	BEAD	S501,S502,S503,S504	2-00053	B3F-1052
Q201	3-00580	3906	U102	3-01405	74AC00
Q202	3-00601	3904	U103	3-01379	68HC912B32
RN401,RN402,RN403,RN404, RN405,RN406,RN407,RN408, RN409,RN410,RN411,RN412, RN413,RN414	4-00407	2.7K	U104,U112	3-00662	74HC14
R101,R110	4-01519	47K	U106	3-00903	MAX6348
R102	4-01479	1.0K	U111	3-00742	74HC74
R103	4-01053	215	U201	3-00728	LM393
R104,R112,R113,R122	4-01527	100K	U202	3-00729	LM741C
R105	4-01511	22K	U203	3-01363	LTC1590
R107	4-01431	10	U206,U204	3-01471	OPA2227
R114,R118,R123,R124,R125, R126	4-01503	10K	U205	3-00542	AD587JR
R115,R117,R119	4-01465	270	U301,U601	3-01289	LT1363
R116,R120,R121,R127,R128, R129,R130	4-01455	100	U302	3-01328	LT1361
			U303,U304	3-01334	THS4081
			U306,U305	3-01244	LT1227
			U310,U308	3-01327	THS4082
			U401,U402,U403,U404,U405, U406,U407	3-00672	74HC595ADT
			U501,U505	3-01424	HDSP-A107
			U502,U503,U504,U506,U507, U508	3-00290	HDSP-A101
			U602	3-01221	BUF634

3.3 Schematic Diagrams

Schematic diagrams follow this page.