

Valuetronics International, Inc.
1-800-552-8258
MASTER COPY

6070A 6071A

Synthesized RF Signal Generators

Operator Manual

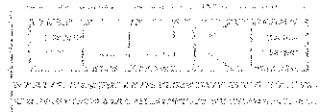

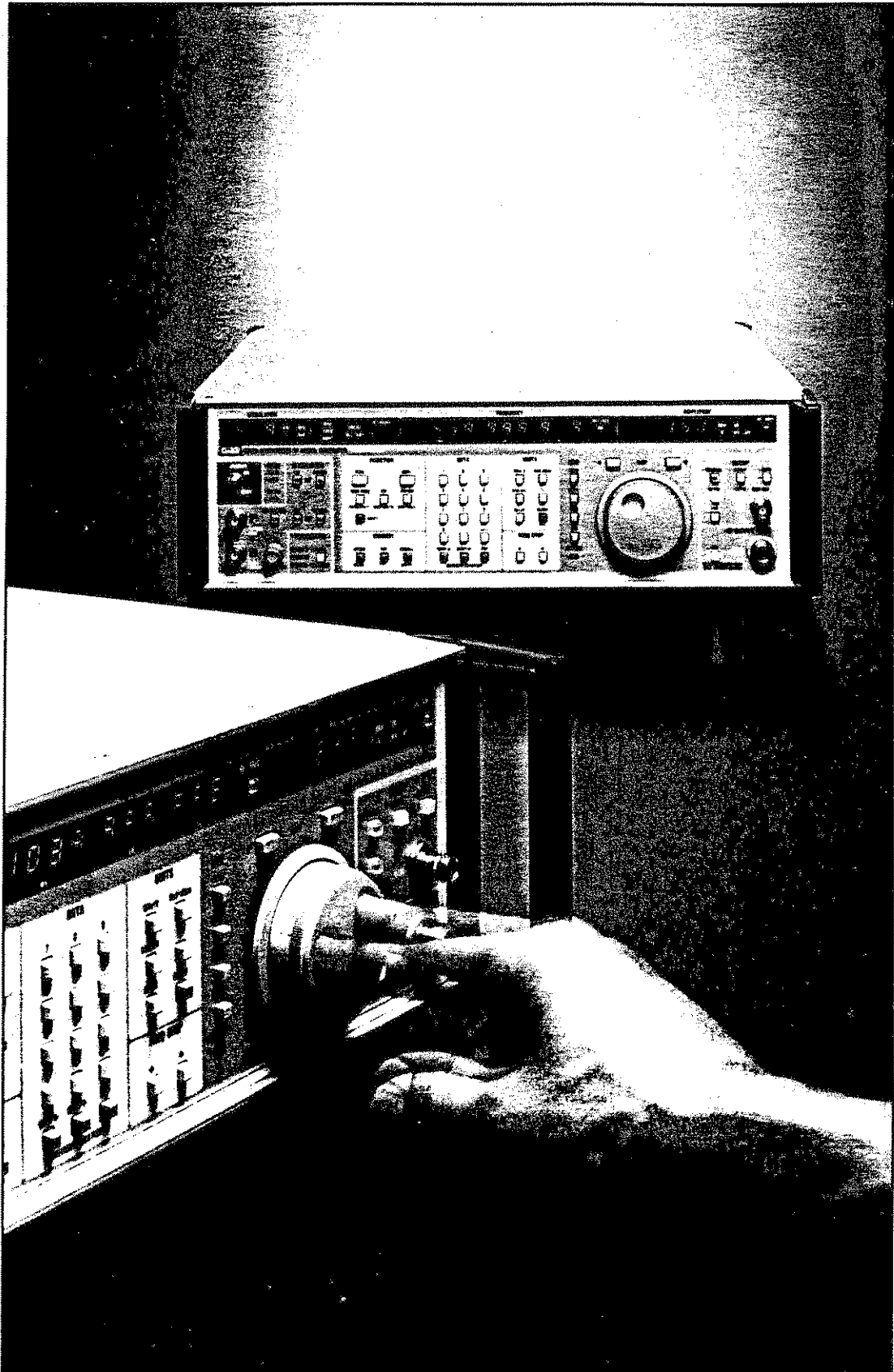

6070A/6071A Synthesized RF Signal Generators

Section 1

Introduction and Specifications

1-1. THE 6070A/6071A INSTRUCTION MANUAL SET

1-2. The John Fluke Models 6070A and 6071A RF Synthesized Signal Generators are documented by a set of four manuals: the 6070A/6071A Operator Manual, the 6070A/6071A Calibration Manual, the 6070A/6071A Service Manual, and the 6070A/6071A Schematic Manual (Figure 1-1). The 6070A/6071A Operator Manual introduces the operator to the instrument; familiarizes the operator with all instrument controls, connectors, and indicators; and presents detailed operating information and procedures for both manual (local) and systems (remote) operation. The 6070A/6071A Calibration Manual provides procedures for general maintenance, performance checks, and calibration adjustments. The 6070A/6071A Service Manual contains a description of the theory of operation, troubleshooting procedures, and a list of replaceable parts. The 6070A/6071A Schematic Manual contains schematic diagrams, wire lists, interconnects diagrams, and an overall basic block diagram of the instrument.

1-3. The major difference between the two models is that the 6071A has twice the upper frequency limit of the 6070A. Because of their similarity, most of the text in this manual will apply to both models. Text that applies to just the 6070A or just the 6071A will be identified as such.

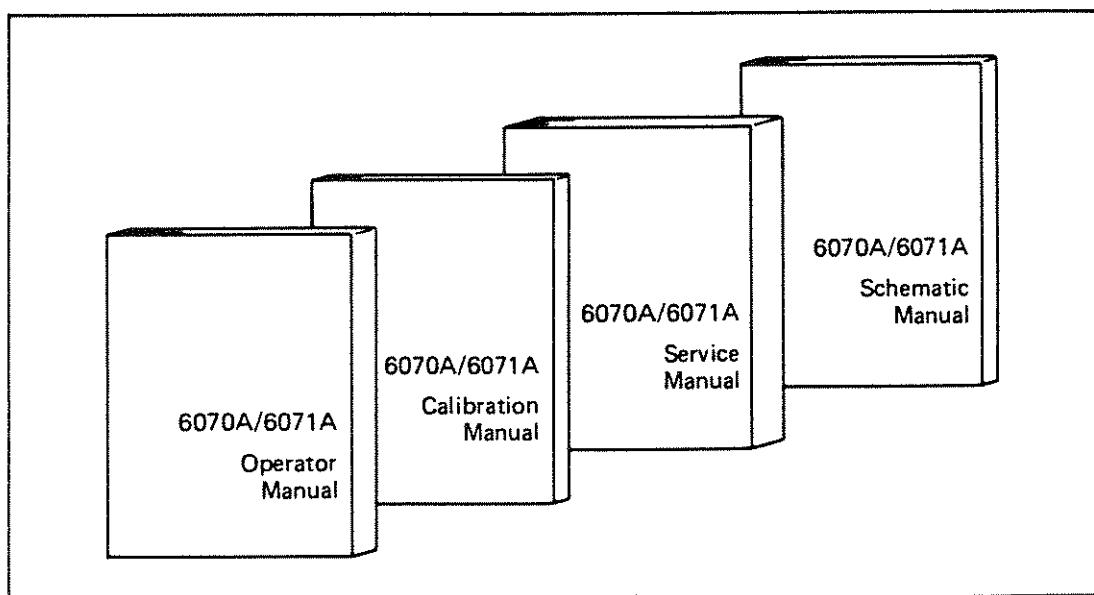

Figure 1-1. 6070A/6071A Instruction Manual Set

1-4. THE 6070A/6071A OPERATOR MANUAL

1-5. The information in this, the 6070A/6071A Operator Manual, is divided into 7 sections:

- | | |
|-------------------------------------|--|
| 1 INTRODUCTION AND SPECIFICATIONS | Introduces the 6070A/6071A Instruction Manual Set and the 6070A and 6071A RF Synthesized Signal Generators. Lists the specifications for both the 6070A and the 6071A. |
| 2 SHIPPING AND SERVICE INFORMATION | Describes how to ship the instrument and how to get problems corrected. |
| 3 INSTALLATION AND MAINTENANCE | Describes how to physically install the instrument -- including connecting line power and the IEEE-488 interface -- and how to perform operator maintenance. |
| 4 FAMILIARIZATION | Describes the location and function of each control, connector, indicator, and annunciator; and presents an exercise to familiarize the operator with the instrument (this exercise also provides a gross check of instrument function). |
| 5 LOCAL OPERATION | Describes manual (front panel) operation of the instrument. |
| 6 REMOTE OPERATION (IEEE-488, 1978) | Describes system operation via the IEEE-488 interface. |
| 7 ACCESSORY AND OPTION INFORMATION | Describes each accessory briefly and describes the capabilities and operation of each option. |

1-6. THE 6070A/6071A SYNTHESIZED RF SIGNAL GENERATOR

1-7. The John Fluke Models 6070A and 6071A Synthesized RF Signal Generators are designed for use in the calibration laboratory, engineering laboratory, or manufacturing environments. Both models offer extensive modulation capabilities and use phase-locked loop circuitry to generate fully synthesized signals with extremely low discrete spurious, and phase noise. These versatile instruments are intended for both bench and systems use. When the instrument is used in a system, all front panel control functions (except POWER and MOD OUT level) can be controlled via an IEEE-488, 1978, interface.

1-8. Instrument parameters, such as output frequency and amplitude, can be programmed to specific values or manually adjusted using the Edit Knob (large knob near the lower right corner of the front panel). The Edit Knob is connected to a digital rotary encoder to provide the same continuous manual adjustment capability that an analog tuning control provides, but with the positive positioning of a digital control. The rotary encoder has 25 magnetic detent positions. The user can feel each position of the Edit Knob.

1-9. The major difference between the two models is that the 6071A has twice the output frequency of the 6070A. The output frequency of the 6070A can be selected within 1 Hz

over a range from 200 kHz to 519.999999 MHz (520 MHz). The output frequency of the 6071A can be selected within 1 Hz from 200 kHz to 520 MHz and within 2 Hz from 520 MHz to 1039.999998 MHz (1040 MHz). Both models can produce frequencies outside of the specified ranges, but the performance is not guaranteed.

1-10. The UNCAL annunciator will turn on to indicate that the instrument is operating beyond specified ranges. The synthesized RF signal is available at the front panel RF OUTPUT connector (if the 607XA-830 Rear Panel Output Option is installed, the RF output is available at a rear panel Type N connector).

1-11. Internal frequency reference is a 10 MHz free air timebase (the 607XA-130 Oven Reference Option is available for increased accuracy and stability). This 10 MHz reference can also be phase locked to external references of 1, 2, 2.5, 5, or 10 MHz (0.3 to 4V peak-to-peak sine or square wave) input via a rear panel BNC connector (50 Ohm input impedance, nominally). When an external reference is used, the shift from internal to external is automatic. The 10 MHz reference signal (used as the internal instrument reference) is available as a TTL signal at a rear panel REF OUT connector.

1-12. Below 520 MHz, output level can be selected with a resolution of 0.1 dB over the range of +19 to -140 dBm (2 V to 22 nV rms) into 50 Ohms. At 520 MHz or above, output level can be selected with a resolution of 0.1 dB over the range of +13 to -140 dBm (1 V to 22 nV rms). Selected level is displayed on the front panel in either dBm or volts (the instrument will convert from one to the other if the units are changed). The internal microprocessor automatically compensates output level for flatness and accuracy although this automatic correction can be disabled (special function 81).

1-13. The RF output signal can be modulated in various combinations of amplitude modulation (AM), frequency modulation (FM), or phase modulation (PM) from internal sources, external sources, or a combination of internal and external sources. Table 1-1 lists all modulation combinations and the possible modulation sources for each combination. Amplitude modulation depth can be selected with a resolution of 0.1% over the range of 0% to 99.9% (see the specifications for calibrated range). The frequency modulation function allows the output frequency to be deviated while the output frequency is still synthesized unless the DCFM Mode is selected. Maximum index of modulation that can be selected for either FM or PM depends upon the output frequency and the modulation frequency selected. The internal modulation signal can be made available at the MOD OUT connectors (front and rear panels). An external modulation signal can be either ac or dc coupled through parallel connectors on the rear and front panels (MOD IN connector, 600 Ohm nominal input impedance). External input sensitivity is such that a 1 V peak input signal produces the calibrated modulation. The list of specifications at the end of this section provides detailed information about the modulation characteristics.

1-14. Up to 9 front panel setups can be stored in the internal memory of the standard instrument, but these setups are lost when the instrument is turned off. The 607XA-570 Non-Volatile Memory Option provides 50 memory locations. Since this option is battery powered, front panel setups stored in these 50 locations are not lost when the instrument is turned off.

1-15. Three outputs are available for coordinating the activity of associated devices: sweep analog output, penlift output, and output invalid output. The sweep analog output is available at the front panel SWP OUT connector. This output steps from 0 to 10V as the frequency is swept from the start frequency to the stop frequency. The size of the steps depends upon the sweep width and the sweep increment selected. The penlift output is

available at a rear panel BNC connector. This output is a TTL signal that goes high during a sweep retrace and stays high until the next sweep starts. The output valid signal is available at a rear panel BNC connector. This output is a TTL signal that goes high when output frequency, output amplitude, or modulation is potentially unsettled.

1-16. The 6070A or 6071A can operate from line voltages either between 90 to 132V ac or between 180 to 264V ac at any frequency from 47 to 63 Hz. Section 3 of this manual presents a procedure for switching between the two ranges of line voltage.

Table 1-1. Sources for Modulation Combinations

COMBINATION	SOURCE	
	INTERNAL	EXTERNAL
AM	AM	
		AM
FM	FM	
		FM
ØM	ØM	
		ØM
AM + FM	AM FM	NONE
	AM	FM
	FM	AM
AM + ØM	AM ØM	NONE
	AM	ØM
	ØM	AM

1-17. OPTIONS AND ACCESSORIES

1-18. The options and accessories available for use with the 6070A and the 6071A are listed in Table 1-2. Additional information is provided in the Options and Accessories section of this manual.

1-19. SPECIFICATIONS

1-20. The specifications for both the 6070A and the 6071A are listed in Table 1-3.

Table 1-2. 6070A/6071A Accessories and Options

MODEL/ OPTION NO.	NAME	COMMENTS
ACCESSORIES		
Y6001	Rack Mount Kit	Includes: M05-205-600 (5½ inch Rack Mount Ears) and M00-280-610 (24-inch Rack Slides).
Y8001	IEEE Standard Cable, 1 meter	
Y8002	IEEE Standard Cable, 2 meters	
Y8003	IEEE Standard Cable, 4 meters	
Y9100	Attenuator, 6 dB	50 Ohm, 2W, BNC
Y9101	Attenuator, 15 dB	50 Ohm, 2W, BNC
Y9102	Attenuator, 20 dB	50 Ohm, 2W, BNC
Y9103	50 Ohm Feedthru Termination, BNC	
Y9111	Coaxial Cable, 50 Ohm, 3 feet (0.91m), BNC	
Y9112	Coaxial Cable, 50 Ohm, 6 feet (1.83m), BNC	
Y9300	Directional Coupler, 100 kHz to 2 GHz, 50 Ohm Impedance, BNC	1.95 dB Coupling, 0.5 dB Insertion Loss, typically 30 dB directivity to 1 GHz.
Y9301	Min-loss Pad, DC to 1 GHz, 50 Ohm In - 75 Ohm Out, 1 W, BNC	Better than 1.2 to 1 VSWR, not more than 6 dB Insertion loss.
Y9302	Attenuator, 3 dB	DC to 1 GHz, 2W average, 50 Ohm.
Y9303	Attenuator, 6 dB	1.25 VSWR max., Type N
Y9304	Attenuator, 10 dB	
Y9305	Attenuator, 20 dB	
Y9306	Attenuator, 30 dB	
Y9307	Adapter, Type N Male to BNC Female, 75 Ohm impedance	
Y9308	Adapter, Type N Male to BNC Female, 50 Ohm Impedance	
Y9309	Adapter, Type N Male to Type N Male	
Y9310	Adapter, Type N Male to SMA Female	
Y9311	RF Detector, Broad Crystal Detector, 50 Ohm, BNC	Total Output Flatness: ±0.6 dB 100 kHz to 1.2 GHz, positive output.
Y9312	Double Balanced Mixer, 500 Hz to 10 MHz, BNC	+7 dBm LO, conversion loss 10 dB max., isolation 20 dB min.
Y9313	Double Balanced Mixer, 2 MHz to 1 GHz, BNC	17 dBm LO, conversion loss 10 dB max., isolation 20 dB min.
Y9314	Power Splitter, 2 MHz to 1 GHz, BNC	
Y9315	Coaxial Cable, 50 Ohm, Type N Male	
Y9316	Cap, Non-shorting, BNC	
Y9317	50 Ohm Termination, Shielded, Type N	

Table 1-2. 6070A/6071A Accessories and Options (cont)

MODEL/ OPTION NO.	NAME	COMMENTS
OPTIONS		
607XA-130	Oven Reference	High stability timebase in an oven.
607XA-570	Non-Volatile Memory	Battery powered memory. Provides 50 storage locations for front panel setups. Retains information for about 4 years.
607XA-830	Rear Panel RF Output	Provides the 6070A RF output to the rear panel via a type N connector.
607XA-831	Auxiliary RF Output	Provides a portion of the RF output at a rear panel BNC connector. This signal is tapped off of the RF output signal before the level detector, so frequency is accurate, but level is not.
607XA-870	Reverse Power Protection	Provides reverse power protection for transceiver test applications (withstands up to 50 watts protection from a 50 Ohm source over the frequency range of 200 kHz to 1040 MHz and will withstand up to 50V dc).

Table 1-3. 6070A/6071A Specifications

Unless otherwise noted, the following performance is guaranteed over the specified environmental and AC line power conditions (see GENERAL at the end of this table), and for normal autoranging operation, 20 minutes after the instrument is turned on.

FREQUENCY**Range**

6070A 0.2 to 519.999999 MHz.

6071A 0.2 to 1039.999998 MHz.

Resolution 1 Hz (2 Hz above 520 MHz for the 6071A).**Accuracy and Stability** Same as the Reference Oscillator.

Switching Time The time from when the signal at the rear panel OUT VALID connector goes false until the frequency of the RF output signal is within 100 Hz of the final value is less than 70 ms (typically, the IEEE and instrument processing time before the signal at OUT VALID goes false is 10 ms).

Connector Type-N, front panel RF OUTPUT connector. 50 Ohms impedance, nominal.

NOTE: The 607XA-830 Rear RF Output Option makes the RF output signal available at the rear panel instead of at the front panel. Specifications for options are listed near the end of this table.

REFERENCE OSCILLATOR**Internal**

TYPE Free-air, 10 MHz crystal oscillator.

AGING RATE $< \pm 0.5$ ppm/monthTEMPERATURE STABILITY ± 5 ppm over the ambient temperature range of 25°C $\pm 25^\circ\text{C}$ (77°F $\pm 45^\circ\text{F}$).

NOTE: The 607XA-130 Oven Reference Oscillator Option provides a more stable internal reference. Specifications of options are listed near the end of this table.

External

CONNECTOR BNC rear panel REF IN connector. Input impedance is nominally 50 Ohms, ac coupled.

INPUT SIGNAL The instrument accepts 0.3 to 4.0V peak-to-peak sine or square wave at 1, 2, 2.5, 5, or 10 MHz.

LOCK RANGE ± 8 ppm frequency difference. Out-of-lock is indicated by the FREQ and UNCAL annunciators.

Reference Output 10 MHz (TTL) available at the rear panel REF OUT connector (BNC).

AMPLITUDE

Specified Range +19 to -140 below 520 MHz.
+13 to -140 520 MHz and above.

NOTE: AM is restricted above +13 dBm (+7 dBm above 520 MHz) and below -131 dBm.

Unspecified Overrange Up to +20.9 dBm and down to -150 dBm, typically.

Resolution 0.1 dB (at least 1% when displaying voltage).

Table 1-3. 6070A/6071A Specifications (cont)

Switching Time The time from when the signal at the rear panel OUT VALID connector goes false until the amplitude of the RF output signal is within 0.1 dB of the final value is less than 10 ms (typically, the IEEE and instrument processing time before the signal at OUT VALID goes false is 10 ms for voltage and 40 ms for dB programming).

Accuracy and Flatness

RF OUTPUT		ACCURACY (dB)**
FREQUENCY (MHz)	LEVEL (dBm)*	
0.2 to 520 MHz (6070A and 6071A)	+19 to +13	±1.5
	+13 to -131	±[0.8 - 0.01 (output level in dBm)]
	-131 to -140	±4.0
520 to 1040 MHz (6071A only)	+13 to +7	±2.5
	+7 to -131	±[1.6 - 0.015 (output level in dBm)]
	-131 to -140	±4.5

*Subtract 6 dB from the level ranges when AM is on (not specified for <-131 dBm).

**Add ±0.5 dB to the accuracy specification if the 607XA-870 Reverse Power Protection Option is installed.

Source SWR (reference to 50 Ohms) Less than the values listed in the following table.

LEVEL (dBm)	SOURCE SWR	
	0.2 TO 520 MHz	520 TO 1040 MHz
≥+7	2.0	2.5
<+7	1.5	2.0

SPECTRAL PURITY

Spurious Spurs are below the values listed in the following table or -140 dBm, whichever is greater (or -130 dBm at 520 MHz if the 607XA-870 Reverse Power Protection Option is installed).

SPURIOUS SIGNALS	SPECTRAL PURITY (dBc)				
	RF OUTPUT FREQUENCY (MHz)				
	0.2 TO 62.5	62.5 TO 125	125 TO 250	250 TO 520	520 TO 1040
Non-harmonic >10 kHz offset*	-90	-100	-96	-90	-84
	<10 kHz offset	-70	-82	-76	-70
	<0.55 kHz offset	-56	-68	-62	-56
Sub-harmonic (f/2, 3f/2, 5f/2, etc.)	N/A				-35
Harmonic 6070A >+13 dBm	-35	-35	-35	-30	N/A
	≤+13 dBm	-35	-35	-35	
Harmonic 6071A >+13 dBm	-35	-35	-30	-25	N/A
	≤+13 dBm	-35	-35	-35	

*Spurs are 5 dB worse during HI DEV Mode operation.

Table 1-3. 6070A/6071A Specifications (cont)

Noise Spectral Density The SSB phase noise density is a function of offset and output frequency. The following performance is guaranteed when not in the HI DEV Mode and includes the effect of the internal reference.

FREQUENCY (MHz)	NOISE SPECTRAL DENSITY (dBc/Hz)				
	OFFSET FROM CARRIER				
	0.1 kHz	1 kHz	5 kHz	20 kHz	>3 MHz
0.2 to 62.5	-75	-85	-107	-123	-129
62.5 to 125	-94	-100	-125	-140	-144
125 to 250	-88	-94	-121	-138	-144
250 to 520	-82	-88	-115	-132	-144
520 to 1040	-76	-82	-109	-126	-138

Signal-to-Phase Noise Ratio vs. Offset Frequency from Carrier at 80, 320, and 500 MHz. (Typical)

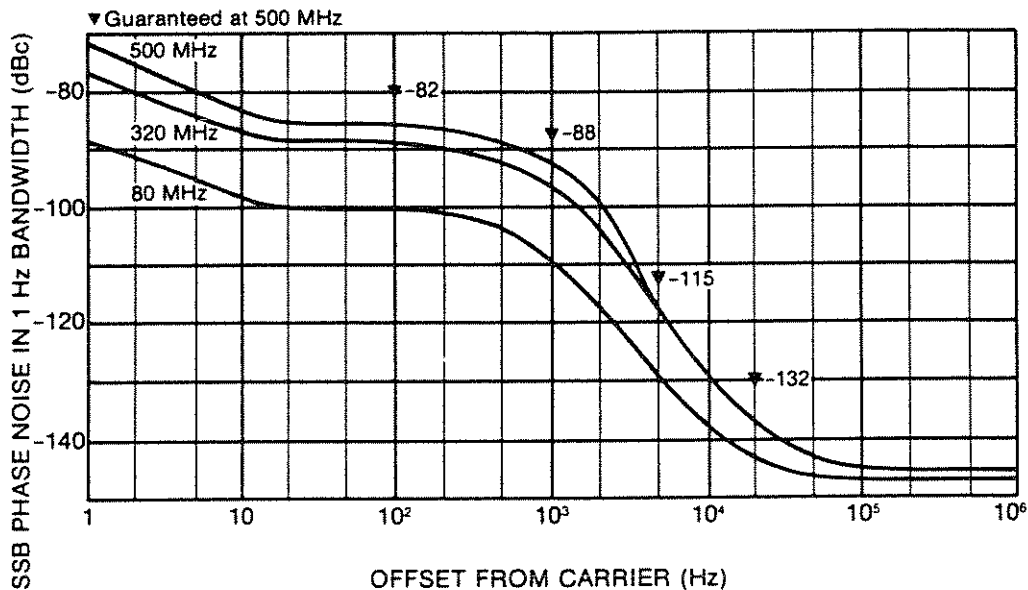
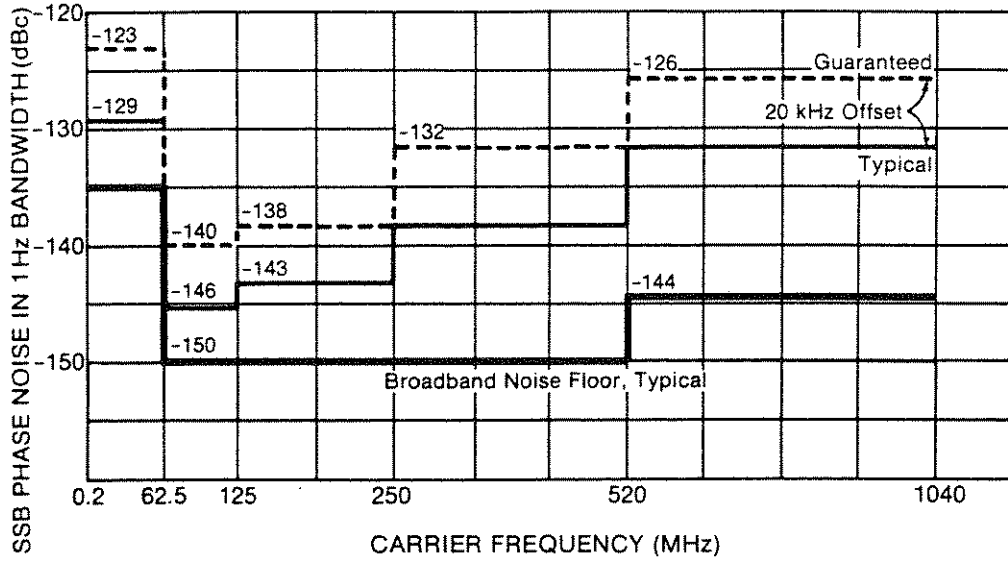
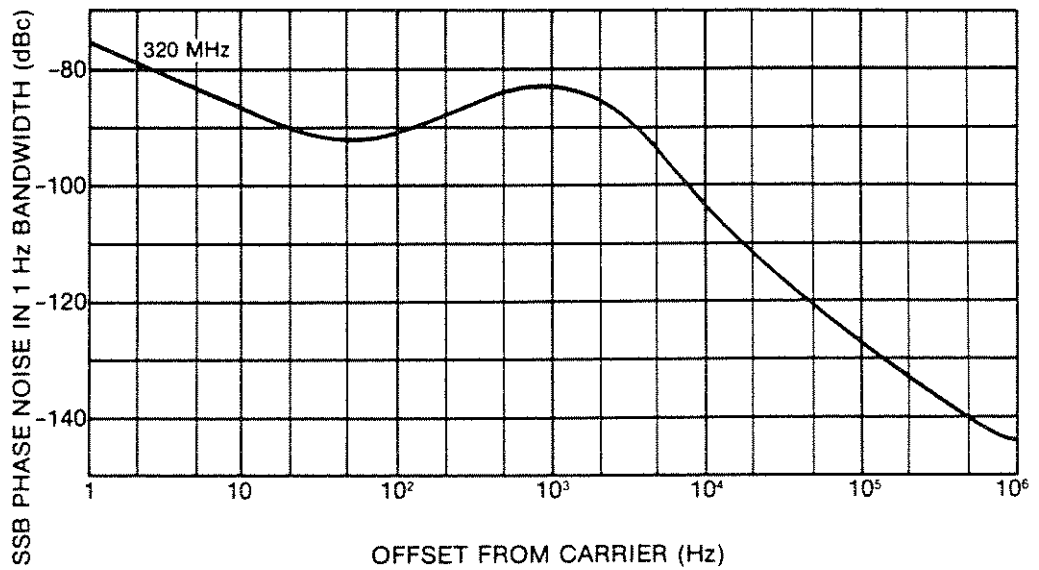

Table 1-3. 6070A/6071A Specifications (cont)

Signal-to-Phase Noise Ratio vs. Carrier Frequency for 20 kHz Offset from Carrier and Broadband Noise Floor (≥ 3 MHz Offset).



Signal-to-Phase Noise Ratio vs. Offset Frequency from Carrier at 320 MHz in HI DEV Mode (Typical).



Residual FM (Hz rms) The following table lists the residual FM for CW (and low deviation ACFM and OM).

FREQUENCY (MHz)	RESIDUAL FM (Hz rms)			
	0.3 TO 3 kHz BW		0.05 TO 15 kHz BW	
	HI DEV OFF	HI DEV ON	HI DEV OFF	HI DEV ON
.2 to 62.5	3.5	20	5	35
62.5 to 125	0.5	5	0.75	9
125 to 250	0.85	10	1.3	18
250 to 520	1.7	20	2.5	35
520 to 1040	3.4	40	5	70

Table 1-3. 6070A/6071A Specifications (cont)

Residual AM <0.02% rms in a 50 Hz to 15 kHz post detection bandwidth on all bands.

AMPLITUDE MODULATION

Depth 0 to 99.9% in 0.1% steps where the total output level (amplitude combined with AM) does not exceed +19 dBm peak at RF output frequencies below 520 MHz or exceed +13 dBm peak for RF output frequencies above 520 MHz.

Accuracy ±5% of full scale above 5 MHz or +5% to -8% of full scale below 5 MHz for rates shown in the Distortion specifications that follow. Amplitude accuracy is not specified below -131 dBm.

Distortion (internal or external)

FREQUENCY (MHz)	RATE	DEPTH FOR SPECIFIED ACCURACY	DISTORTION		
			0 TO 30% AM	30 TO 70% AM	70 TO 90% AM
0.2 to 5	≤1 kHz	<90%	<2%	<5%	<7%
5 to 520	≤3 kHz	<90%	<1.5%	<3%	<3%
520 to 1040	≤3 kHz	<70%	<2%	<3%	<5%

Bandwidth, 3 dB at 90% AM for RF output frequencies between 5 MHz and 520 MHz or at 70% AM for RF output frequencies below 5 MHz and above 520 MHz.

FREQUENCY (MHz)	DC COUPLED	AC COUPLED
0.2 to 5	0 to 8 kHz	20 Hz to 8 kHz
5 to 1040	0 to 50 kHz	20 Hz to 50 kHz

Incidental FM <0.2 fm for 30% AM (<0.6 fm above 520 MHz for 6071A), where fm is modulation frequency, at the rates listed in the Distortion specifications.

FREQUENCY MODULATION

Deviation Ranges

FREQUENCY (MHz)	DEVIATION RANGES (kHz)	
	HI DEV MODE OFF	HI DEV MODE ON
0.2 to 62.5	10, 20, 50, 100, 200	50, 100, 200, 500, 1000
62.5 to 125	2, 5, 10, 20, 50	10, 20, 50, 100, 200
125 to 250	5, 10, 20, 50, 100	20, 50, 100, 200, 500
250 to 520	10, 20, 50, 100, 200	50, 100, 200, 500, 1000
520 to 1040	20, 50, 100, 200, 500*	100, 200, 500, 1000

*HI DEV. MODE ON if deviation >400 kHz.

Resolution 100 Hz up to 99.9 kHz Dev
1 kHz above 99.9 kHz Dev

Table 1-3. 6070A/6071A Specifications (cont)

Maximum Deviation

FREQUENCY (MHz)	MAXIMUM DEVIATION (kHz)	
	ACFM THE LESSER OF:	DCFM THE LESSER OF:
0.2 to 62.5*	999 or fm(520 - fo)	499 kHz
62.5 to 125	199 or fmfo	fo or 99.9
125 to 250	499 or fmfo	fo or 199
250 to 520	999 or fmfo	fo or 499
520 to 1040	999 or fmfo	fo or 999

Where: fm = the numeric value of modulation frequency expressed in kHz.
fo = the numeric value of the RF output frequency in MHz.

*At low RF output frequencies, the sum of the modulation frequency and the deviation should not exceed $1000(fo - 0.2) - fm$.

Minimum Deviation 10% of range except for 2, 20, and 200 kHz ranges
12.5% of range for 2, 20, and 200 kHz ranges.

Deviation Accuracy (internal or external, AC or DC)

AT 400 AND 1000 Hz

HI DEV Off $\pm(10\% + 0.125\%$ of range)

HI DEV On $\pm(7\% + 0.125\%$ of range)

FROM 0.3 TO 50 kHz (HI DEV on

or off, DCFM on or off) $\pm(12\% + 0.125\%$ of range)

Distortion The total harmonic distortion on internal or on external sources up to a 50 kHz rate is a function of output frequency and mode, and is less than the values listed in the following table.

FREQUENCY (MHz)	DISTORTION (% THD)	
	HI DEV OFF	HI DEV ON
0.2 to 62.5	$0.5 + 0.75/100$ kHz DEV	1.5
62.5 to 125	$0.5 + 3/100$ kHz DEV	1.5
125 to 250	$0.5 + 1.5/100$ kHz DEV	1.5
250 to 520	$0.5 + 0.75/100$ kHz DEV	1.5
520 to 1040	$0.5 + 0.375/100$ kHz DEV	1.5

NOTE: Distortion for the DCFM Mode is 0.5% plus 1.2% per 100 kHz DEV below 62.5 MHz or $(600/fo)\%$ per 100 kHz DEV above 62.5 MHz. The specification applies at the ambient temperature at which DCFM is enabled, where fo is the RF output frequency in MHz.

Bandwidth The frequency where the response is 3 dB below the maximum is at least 250 kHz at the high end and less than 20 Hz at the low end when AC coupled.

Incidental AM <0.5% AM for up to 50 kHz deviation at a 1 kHz rate.

Table 1-3. 6070A/6071A Specifications (cont)

Center Frequency Accuracy Same as the reference oscillator for ACFM. The center frequency accuracy values are listed in the following table for the DCFM Mode (after enabling DCFM).

FREQUENCY (MHz)	MAXIMUM INITIAL OFFSET (Hz)	TYPICAL FREQUENCY STABILITY (Hz/MINUTE)
0.2 to 62.5	±1000	50
62.5 to 125	±250	12.5
125 to 250	±500	25
250 to 520	±1000	50
520 to 1040	±2000	100

PHASE MODULATION

Index Ranges

FREQUENCY (MHz)	INDEX RANGES (RADIAN)	
	HI DEV OFF	HI DEV ON
0.2 to 62.5	1, 2, 5, 10, 20	5, 10, 20, 50, 100
62.5 to 125	0.2, 0.5, 1, 2, 5	1, 2, 5, 10, 20
125 to 250	0.5, 1, 2, 5, 10	2, 5, 10, 20, 50
250 to 520	1, 2, 5, 10, 20	5, 10, 20, 50, 100
520 to 1040	2, 5, 10, 20, 50*	10, 20, 50, 100

*HI DEV Mode if index > 40 Radians.

Resolution 0.01 radian up to 9.99 radian.
0.1 radian above 99.9 radian.

Maximum Index Same as the highest available range.

Minimum Index 10% of range except for 0.2, 2, and 20 radian ranges
12.5% of range for 0.2, 2, and 20 radian ranges.

Index Accuracy (internal or external)

AT 400 AND 1000 Hz

HI DEV Off ±(10% + 0.125% of range)

HI DEV On ±(7% + 0.125% of range)

FROM 0.3 TO 3 kHz (HI DEV ON

OR OFF) ±(12% + 0.125% of range)

Distortion The total harmonic distortion is less than the values in the following table.

FREQUENCY (MHz)	HI DEV OFF	HI DEV ON
0.2 to 62.5	0.5% + (0.75 × 10 ⁻⁵ fm)% per Rad	1.5%
62.5 to 125	0.5% + (3.0 × 10 ⁻⁵ fm)% per Rad	1.5%
125 to 250	0.5% + (1.5 × 10 ⁻⁵ fm)% per Rad	1.5%
250 to 520	0.5% + (0.75 × 10 ⁻⁵ fm)% per Rad	1.5%
520 to 1040	0.5% + (0.37 × 10 ⁻⁵ fm)% per Rad	1.5%

Where fm is the numerical value of the modulation frequency in Hz.

Table 1-3. 6070A/6071A Specifications (cont)

Bandwidth	The frequency where the response is 3 dB below the maximum is at least 12 kHz at the high end and less than 20 Hz (ac coupled) or dc (dc coupled) at the low end.
Incidental AM	<0.5% AM for deviations up to 50 radians at 1 kHz rate
EXTERNAL MODULATION INPUT	
Connector	Front and rear panel MOD IN connectors (BNC), connected in parallel, with a nominal 600 Ohm input impedance.
External Input Sensitivity	1V peak provides the programmed modulation depth.
INTERNAL MODULATION OSCILLATOR	
Frequency Ranges	20 Hz to 199 Hz 200 Hz to 1,990 kHz 2 kHz to 19.9 kHz 20 kHz to 199 kHz
Unspecified Overrange	Down to 1 Hz and up to 255 kHz.
Frequency Accuracy	$\pm 3\%$ over the range 20 to 30°C (68 to 86°F). $\pm(3\% + 0.1\%/^{\circ}\text{C})$ below 20 and above 30°C.
Distortion	<0.15% THD from 0.2 to 100 kHz <0.2% THD below 0.2 kHz and above 100 kHz.
Output	Front panel MOD OUT connector (BNC) and associated level control provide nominally 0 to 1 volt peak into 600 Ohms. Level is not programmable. Output impedance is 600 Ohms, nominal.
OTHER OUTPUTS	
Sweep Analog Output	Front panel SWP OUT connector (BNC) provides 0 to 10V up to a 1000 point stepped ramp. Accuracy of the output is $\pm 5\%$ of output $\pm 0.1\text{V}$.
Penlift	Rear panel PEN LIFT connector (BNC) provides a TTL signal which is high during sweep retrace and until the next sweep starts.
Output Valid	Rear panel OUT VALID connector (BNC) provides a TTL signal which is low when the RF output is potentially unsettled. This signal is also available on the IEEE interface.

Table 1-3. 6070A/6071A Specifications (cont)

MEMORY

Memory Functions	Store, recall, insert above, delete, define top.
Number of Locations	9 standard, volatile (contents are lost when power is removed); 50 with the 607XAA-570 Non-Volatile Memory Option (contents are retained for about 4 years after power is removed). Front panel setups can be stored in each location and later recalled.

FREQUENCY SWEEP

Sweep Modes	Auto, (repetitive), single, manual.
Sweep Functions	Symmetrical sweep, asymmetrical sweep, sweep speed.
Data Entry Parameters	Sweep width and sweep increment.
Sweep Speed	When slow sweep speed is not selected, the instrument will sweep frequency as fast as possible without regard to whether or not the frequency is settled. When slow sweep speed is selected, the settled period of each increment can be set to 20 ms, 50 ms, 100 ms, 200 ms, and 500 ms.
Sweep Output	0 to +10V, up to 1000-point stepped ramp. Available at the front panel SWP OUT connector.
Penlift/Z Axis Blanking Output	TTL level at the rear panel PEN LIFT connector. High during sweep retrace and until the next sweep starts.

REMOTE CONTROL

Interface	IEEE Standard 488, 1978.
Functions Controlled	All front panel controls except the POWER and MOD OUT controls.
Status Indicators	REM (remote), ADDR (addressed), SRQ.
Interface Functions	SH1, AH1, T6, TE0, L3, LE0, SR1, RL1, PP0, DC1, DT1, C0.

GENERAL

Temperature	
OPERATING	0 to 50°C (32 to 122°F)
NON-OPERATING	-40 to 75°C (-40 to 167°F)
Operating Humidity	
	0 to 95% up to 25°C (77°F)
	0 to 75% up to 50°C (122°F)

Table 1-3. 6070A/6071A Specifications (cont)

Conducted and Radiated Interference	<3 uV induced in a 2 turn, 1-inch loop that is 1 inch from any surface and measured into a 50 Ohms receiver. Complies with RE02 and CE03 of MIL-STD-461A, sections 4.3.1 and 4.3.2 of MIL-I-6181D, both narrow and broad band.		
Size	width	height	depth
	43 cm	13.3 cm	54.6 cm
	17 inches	5.25 inches	21.5 inches
Weight	28 kg (61 lbs.)		
Power	100, 120, 200, and 240V ac $\pm 10\%$, 47 to 63 Hz.		
Protection Class	Class 1 (as defined in IEC 348)		
OPTIONS			
607XA-130 Oven Reference Option			
FREQUENCY	10 MHz		
AGING RATE	$< \pm 5 \times 10^{-10}$ /day, after a 21 day warmup.		
TEMPERATURE STABILITY	$< \pm 2 \times 10^{-10}/^{\circ}\text{C}$.		
POWER	On during standby operation (STBY indicator on).		
607XA-570 Non-Volatile Memory Option			
NUMBER OF LOCATIONS	50		
STORAGE TIME	With power removed, the contents will be retained for about 4 years.		
POWER SOURCE	Instrument power supply, operating or in standby. Battery when power is removed.		
POWER-ON CONDITION	Instruments with this option return the front panel to the setup that existed when the instrument was placed in standby or was turned off.		
607XA-830 Rear RF Output Option (replaces the front panel RF OUTPUT connector)			
SPECIFICATIONS	Same as standard instrument.		
CONNECTOR	Type N, rear panel RF OUT connector.		
607XA-831 Auxiliary RF Output Option			
FREQUENCY	Same as RF output frequency.		
AMPLITUDE	> -18 dBm for normal autoranging operation.		
IMPEDANCE	50 Ohms, nominal.		
CONNECTOR	BNC, rear panel AUX OUT connector.		

Table 1-3. 6070A/6071A Specifications (cont)

607XA-870 Reverse Power Protection**Option**

PROTECTION LEVEL	Up to 50 watts from a 50 Ohm source over the frequency range of 0.2 to 1040 MHz. Will withstand up to 50V dc (dc blocking capacitor at the output).
LEVEL ACCURACY	Add ± 0.5 dB to Amplitude Accuracy (listed earlier in this table).
HARMONICS	Degrade harmonics specifications (listed earlier in this table) by 5 dB for levels above +13 dBm.

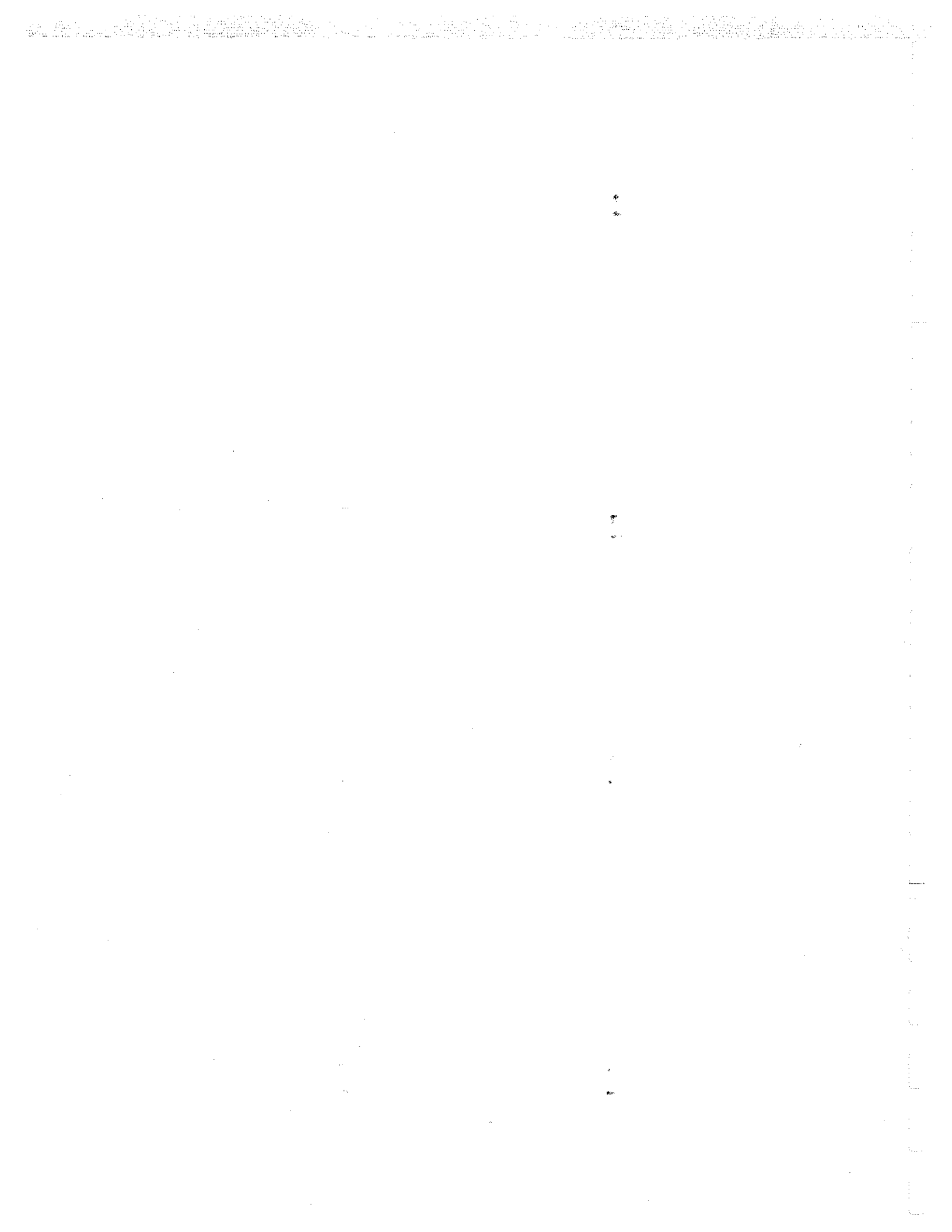

Section 2

Shipping and Service Information

2-1. SHIPPING INFORMATION

2-2. The instrument is packaged and shipped in a foam-packed container. When you receive the instrument, inspect it thoroughly for possible shipping damage. Special instructions for inspection and claims are included in the shipping container.

2-3. If reshipment is necessary, use the original container. If the original container is not available, order a new container from the John Fluke Mfg. Co., Inc.; P.O. Box 43210; Mountlake Terrace; Wa 98043; telephone (206) 774-2211. When ordering a new shipping container, state the instrument model number.

2-4. SERVICE INFORMATION

2-5. Warranty

2-6. Each John Fluke Model 6070A or 6071A Synthesized RF Signal Generator is warranted for a period of 1 year upon delivery to the original purchaser. The WARRANTY is located at the front of this manual.

2-7. Service

2-8. Factory authorized service (including calibration) for either the 6070A or the 6071A is available at selected John Fluke Technical Service Centers. For service and/or calibration, return your instrument to the nearest John Fluke Technical Service Center. The local technical service center will handle transportation to and from the selected technical service centers as required. Tables A-1 and A-2 in Appendix A provide a complete list of John Fluke Technical Service Centers. Appendix A is located at the rear of this manual. If requested, you will be provided with an estimate before work is begun on instruments that are beyond the warranty period.

2-9. ADDITIONAL INFORMATION

2-10. For any additional information, contact your nearest John Fluke Sales Representative or the John Fluke Mfg. Co., Inc.; P.O. Box 43210; Mountlake Terrace; WA 98043; telephone (206) 774-2211. Tables A-3 and A-4 in Appendix A provide a complete list of John Fluke Sales Representatives. Appendix A is located at the end of this manual.

Section 3

Installation and Maintenance

3-1. INTRODUCTION

3-2. This section contains the information necessary to install the open termination units, to physically mount the instrument, to connect line power to the instrument, to connect the instrument electrically to the IEEE-488 interface, and to perform operator maintenance.

3-3. MOUNTING: RACK OR BENCH

CAUTION

The instrument should have at least 3 inches of clearance behind the ventilation fan for adequate cooling.

3-4. The 6070A and 6071A are designed to be either placed directly on the work bench or to be mounted in standard 24-inch deep equipment racks using the Y6001 rack mounting accessory. The Y6001 is composed of the two Fluke accessories listed in Table 3-1. Figure 3-1 shows these accessories.

3-5. INPUT LINE POWER

WARNING

TO AVOID SHOCK HAZARD OR INSTRUMENT DAMAGE, CONNECT THE INSTRUMENT LINE POWER GROUND TO EARTH GROUND. DO NOT BREAK THIS GROUND CONNECTION BY USING A TWO CONDUCTOR EXTENSION CORD.

3-6. The instrument can operate from various line power configurations. Line power voltage can be from 90 to 132V ac rms or from 180 to 264V ac rms. Line frequency can be 47 to 63 Hz (Call or write the John Fluke Mfg. Co., Inc.; P.O. Box 43210; Mountlake Terrace; WA 98043; telephone number (206) 774-2211. **DO NOT ATTEMPT TO OPERATE THE INSTRUMENT WITH A 400 HZ INPUT WITHOUT FIRST CALLING OR WRITING FOR INFORMATION ON 400 HZ OPERATION**). Your instrument is factory set to operate with a line voltage of 90 to 132V ac rms. Use the Operator Maintenance procedures described later in this section to determine the line voltage selected for your instrument or to change the line voltage selected for your instrument. Use the following procedure when connecting your instrument to line power

1. On the instrument, set the POWER control (front panel) to the STBY position and set the MAIN POWER switch (rear panel) to the OFF position.
2. Connect the instrument to an appropriate line power source.

Table 3-1. Rack Mounting Accessories, Y6001

MODEL	NAME
M05-205-600	5½-inch Rack Mount
M00-280-610	24-inch Rack Slides

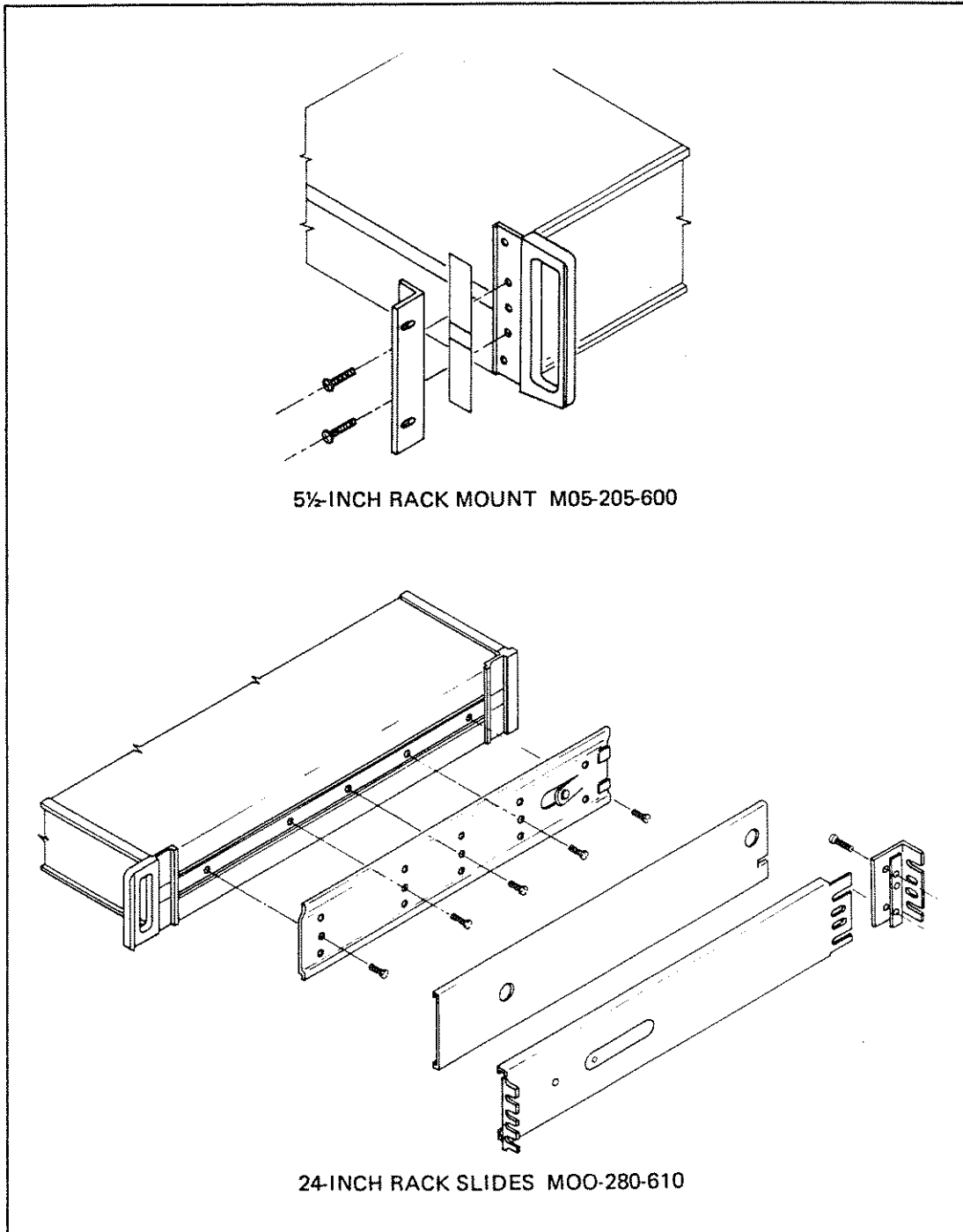

Figure 3-1. Rack Mounting Accessories, Y6001

WARNING

IF THE FRONT PANEL STBY POWER INDICATOR DOES NOT TURN ON WITHIN ONE MINUTE AFTER THE MAIN POWER SWITCH IS SET TO THE ON POSITION, SET THE MAIN POWER SWITCH TO THE OFF POSITION TO PREVENT ADDITIONAL INSTRUMENT DAMAGE. TROUBLESHOOTING AND REPAIR IS INDICATED.

3. Set the Rear Panel Power switch to the ON position. If the front panel STBY POWER indicator does not turn on within 1 minute, set the Rear Panel Power switch to the OFF position. Troubleshooting and repair is indicated.

4. When the STBY POWER indicator turns on, the instrument is in the standby condition. The 607XA-130 Oven Reference Option and the 607XA-570 Non-Volatile Memory Options, if installed, receive power in standby. No other instrument circuit receives power during standby.

3-7. RF EMISSION CONTROL

3-8. For applications which are sensitive to RF emissions, it is recommended that BNC open termination units be installed on all unused rear panel connectors.

3-9. IEEE-488**3-10. Electrical Connection**

3-11. The IEEE-488 Connector (rear panel) mates with any standard 24-conductor IEEE-488 cable. Figure 3-2 shows the pin-outs on the connector. IEEE-488 system connections must not exceed the following limits:

1. No more than 15 devices may be connected in a single IEEE-488 Bus system.
2. The total length of cable used in one IEEE-488 Bus system must not exceed 20 meters.
3. The total length of cable must also not exceed 2 meters times the number of devices in the system.

3-12. Table 3-2 lists IEEE Standard Cables available from Fluke in lengths of 1, 2, and 4 meters. Combinations of these cables can be used to meet the IEEE-488 Bus system cable restrictions. For example, when only the signal generator is connected to a controller, the number of devices is 2. According to limit 3, the total length of cable must not exceed two meters times the number of devices. So, the total length of cable must be 4 meters or less. Therefore, any one of the accessory cables can be used to connect the two instruments.

3-13. IEEE-488 INTERFACE Switches

3-14. The positions of the IEEE-488 INTERFACE switches (rear panel) determine the IEEE-488 address of the instrument and determine whether the instrument is both a talker and a listener or just a listener. Set the LISTEN ONLY switch to the ON (up) position to make the instrument just a listener. Set the LISTEN ONLY switch to the OFF (down) position to make the instrument both a talker and a listener. The positions of the five switches a1 through a5 determine the IEEE-488 address of the instrument. The IEEE-488 address is the same for both the listener and the talker functions. Set the switches to the positions indicated in Table 3-3 for the desired address. If LISTEN ONLY is at the ON position, the instrument is always addressed, so the positions of a1 through a5 will have no meaning.

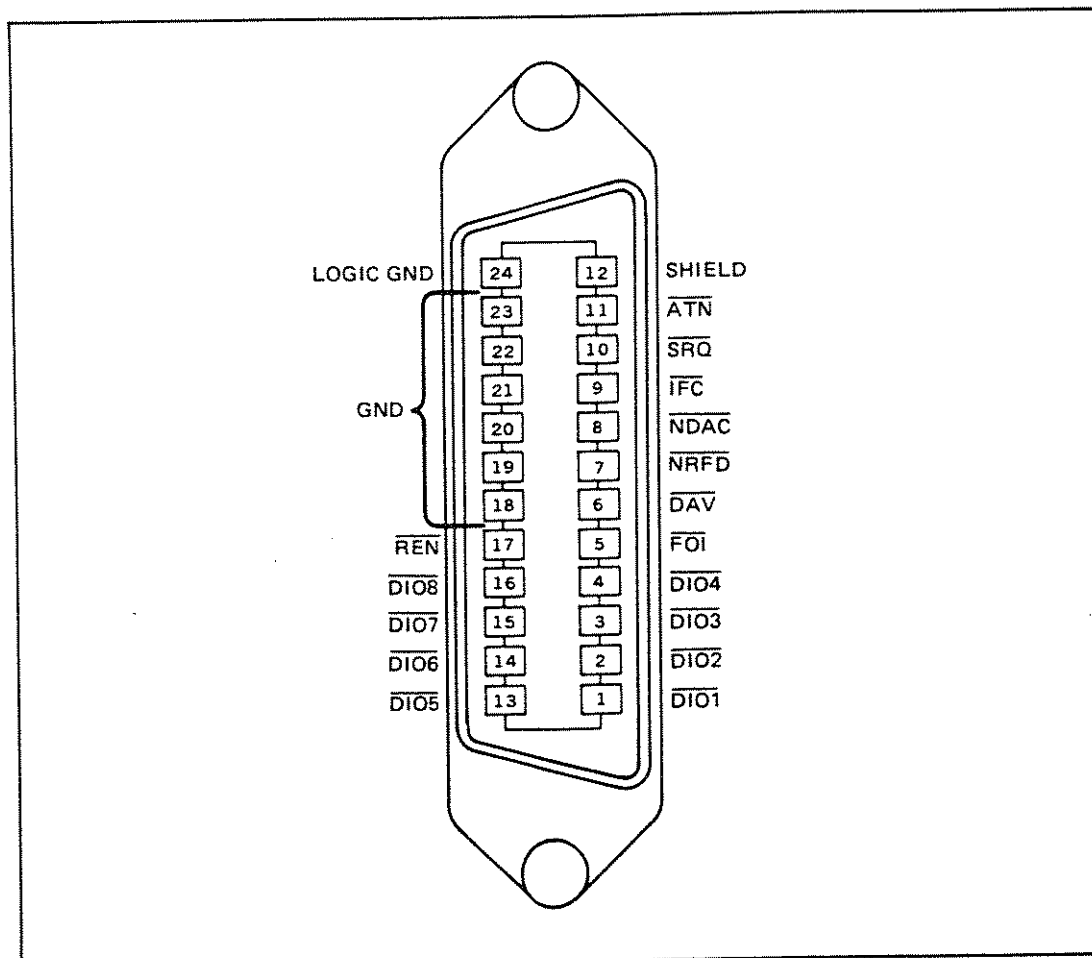

Figure 3-2. IEEE-488 Connector

Table 3-2. IEEE-488 Cable Accessories

MODEL NUMBER	NAME
Y8001	IEEE Standard Cable, 1 meter
Y8002	IEEE Standard Cable, 2 meters
Y8003	IEEE Standard Cable, 4 meters

3-15. OPERATOR MAINTENANCE

3-16. Fuse Replacement

3-17. The instrument has two fuses: the main power fuse and the auxiliary power supply fuse. The main power fuse can be replaced from the rear panel of the instrument, but the instrument must be partially disassembled to replace the auxiliary power supply fuse. The following procedure describes how to replace the main power fuse. Replacement of the auxiliary power supply fuse is described in the 6070A/6071A Calibration Manual.

1. Set the POWER control to the STBY position, set the MAIN POWER switch to the OFF position, and disconnect line power.

Table 3-3. IEEE-488 Address

IEEE-488 BUS ADDRESS	IEEE-488 INTERFACE SWITCH POSITIONS				
	a5	a4	a3	a2	a1
00	DN	DN	DN	DN	DN
01	DN	DN	DN	DN	UP
02	DN	DN	DN	UP	DN
03	DN	DN	DN	UP	UP
04	DN	DN	UP	DN	DN
05	DN	DN	UP	DN	UP
06	DN	DN	UP	UP	DN
07	DN	DN	UP	UP	UP
08	DN	UP	DN	DN	DN
09	DN	UP	DN	DN	UP
10	DN	UP	DN	UP	DN
11	DN	UP	DN	UP	UP
12	DN	UP	UP	DN	DN
13	DN	UP	UP	DN	UP
14	DN	UP	UP	UP	DN
15	DN	UP	UP	UP	UP
16	UP	DN	DN	DN	DN
17	UP	DN	DN	DN	UP
18	UP	DN	DN	UP	DN
19	UP	DN	DN	UP	UP
20	UP	DN	UP	DN	DN
21	UP	DN	UP	DN	UP
22	UP	DN	UP	UP	DN
23	UP	DN	UP	UP	UP
24	UP	UP	DN	DN	DN
25	UP	UP	DN	DN	UP
26	UP	UP	DN	UP	DN
27	UP	UP	DN	UP	UP
28	UP	UP	UP	DN	DN
29	UP	UP	UP	DN	UP
30	UP	UP	UP	UP	DN
31	UP	UP	UP	UP	UP

2. On the rear panel, remove the six allen screws that hold the RFI shield over the main power fuse and the line voltage selection switch (Figure 3-3).
3. Replace the main power fuse with a 3A, 250V, FAST BLO fuse. Do not substitute another fuse type.
4. Replace the RFI shield.
5. Connect line power to the instrument and set the MAIN POWER switch and the POWER control to the ON positions.

3-18. Changing Line Power Configuration

3-19. Figure 3-3 shows the line voltage selection switch. This control determines whether the instrument will operate in a 90 to 132V ac rms line voltage environment or a

180 to 264V ac rms line voltage environment. Use the Fuse Replacement procedure to gain access to the switch, then set the switch to the position for the line voltage desired. The white window on the switch will show 115 for the 90 to 132V position and 230 for the 180 to 264V position.

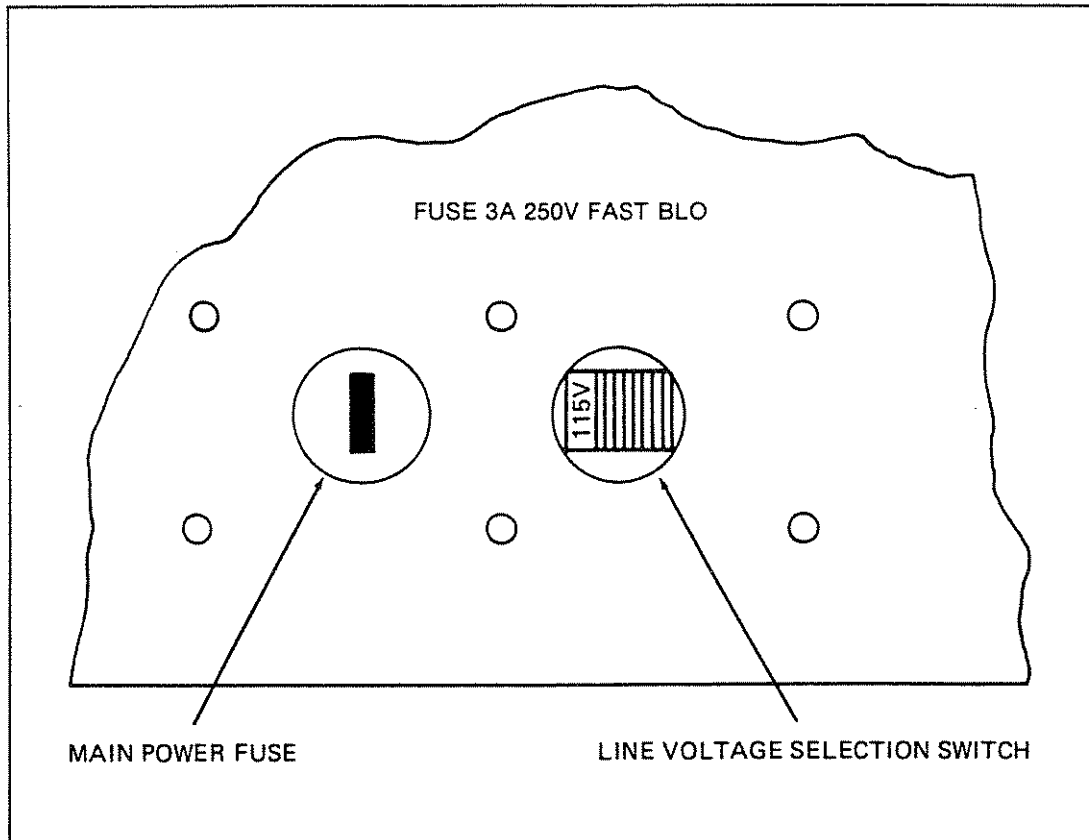

Figure 3-3. Main Power Fuse and Line Voltage Selection Switch