

Tektronix[®]
COMMITTED TO EXCELLENCE

**1480-SERIES
WAVEFORM
MONITORS**
(B060000 and above)

INSTRUCTION MANUAL

Tektronix, Inc.
P.O. Box 500
Beaverton, Oregon 97077

Serial Number B079220

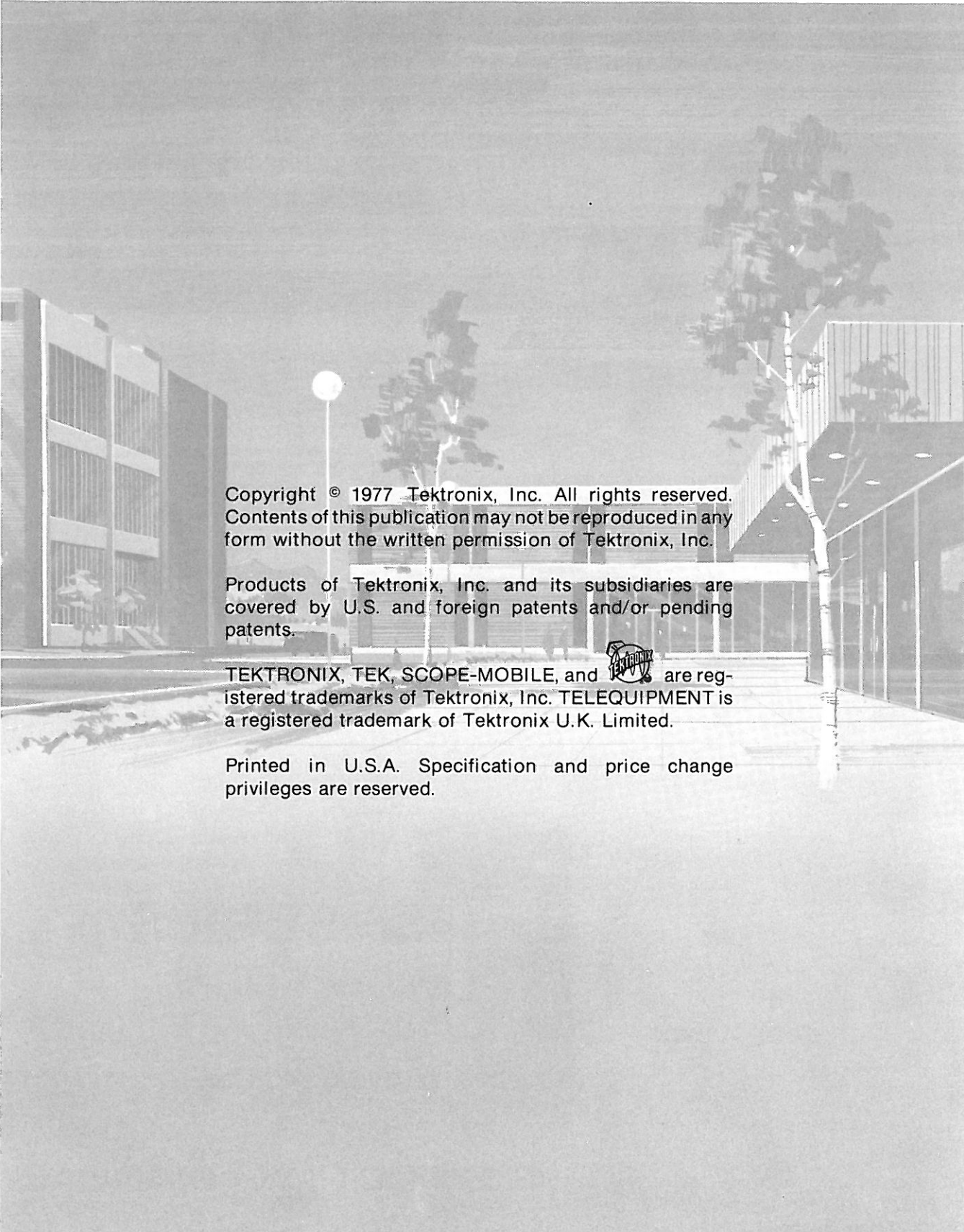

Copyright © 1977 Tektronix, Inc. All rights reserved.
Contents of this publication may not be reproduced in any
form without the written permission of Tektronix, Inc.

Products of Tektronix, Inc. and its subsidiaries are
covered by U.S. and foreign patents and/or pending
patents.

TEKTRONIX, TEK, SCOPE-MOBILE, and  are reg-
istered trademarks of Tektronix, Inc. TELEQUIPMENT is
a registered trademark of Tektronix U.K. Limited.

Printed in U.S.A. Specification and price change
privileges are reserved.

SAFETY SUMMARY

The following are general safety precautions that must be observed during all phases of operation.

WARNING information in this manual is intended to protect personnel from hazardous primary voltages.

CAUTION information is intended to protect the instrument from damage.

WARNING

Electrical shock hazards are present inside this instrument. Only qualified service personnel should remove the instrument cover.

WARNING

To reduce the electrical shock hazard, the instrument chassis must be properly grounded. Refer to Section 1, Unpacking and Incoming Inspection.

WARNING

Do not service or make internal adjustments to this instrument unless another person, capable of giving first aid and resuscitation, is present.

Avoid live circuits. Electrical shock hazards are present in this instrument, especially in the power-supply primary circuits (fuse holder, power switch and transformer primary terminals), the high voltage for crt operation, and the +140 V supply to the Horizontal Output circuit board.

WARNING

The crt used in the 1480-Series Waveform Monitor is a high vacuum device and should be handled with care. Be sure to read the warnings and procedure for crt replacement in SECTION 7 before attempting to remove the crt.

WARNING

Avoid coming in contact with components that are operating at high temperatures, such as high-wattage resistors (spaced above the circuit boards), power transistors, some of the metal-can transistors, and some of the integrated circuits (IC).

WARNING

Handle silicon grease with care. Avoid getting it in eyes or mouth, wash hands after using silicon grease.

Power Transistors. The power transistors, that are heat sunked to metal parts of the 1480-Series Waveform Monitor, are mounted with silicon grease.

CAUTION

For continued fire hazard protection, replace mains fuse with the type and rating listed on the instrument rear panel and in the electrical parts list.

CAUTION

Read the soldering instructions in SECTION 7 before attempting to solder on the circuit boards contained in this instrument.

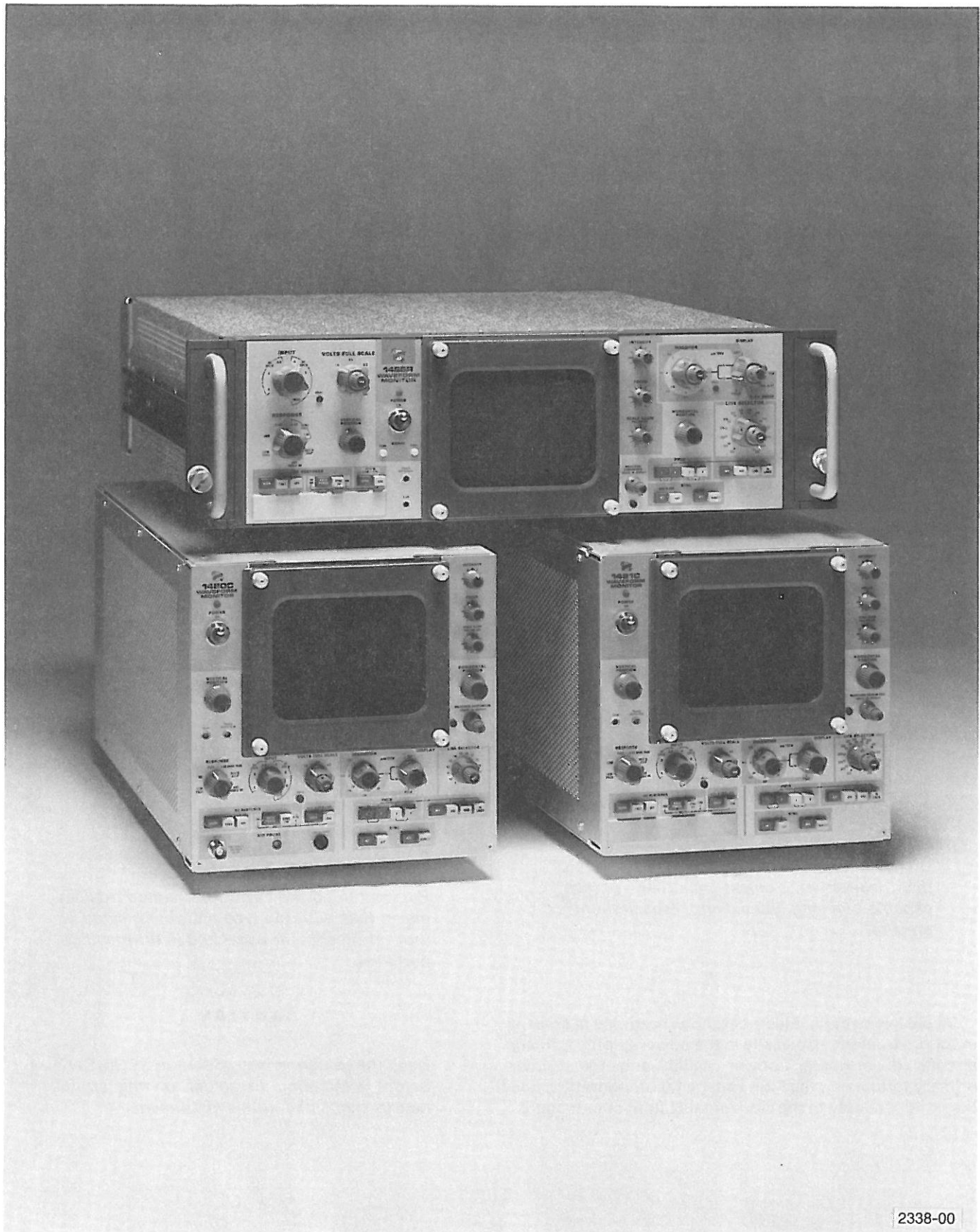

2338-00

Fig. 1-1. 1480-Series Waveform Monitors, showing both rackmount and cabinet models.

PART 1

OPERATING INFORMATION

INTRODUCTION

This manual is divided into two parts. The first part (OPERATING INFORMATION) is designed for use by anyone who needs to know how to operate a 1480-Series Waveform Monitor. Part two (SERVICE INFORMATION) contains the information necessary to maintain the accuracy of a 1480-Series Waveform Monitor. Part two should only be used by qualified service personnel; servicing exposes personnel to hazardous voltages.

Section 1—1480-Series (SN B060000-up)

UNPACKING AND INCOMING INSPECTION

The 1480-Series Waveform Monitor operates from a single-phase power source with one of the current-carrying conductors (neutral conductor) at ground (earth) potential. Operation from power sources where both current-carrying conductors are live with respect to ground (such as phase-to-phase on a 3-wire system) is not recommended, since only the line conductor has over-current (fuse) protection within the instrument.

of the instrument. For electric-shock protection, insert the power plug in a mating outlet with an earth-ground contact. Table 1-1 gives the conductor color codes of power cords used in Tektronix instruments.

TABLE 1-1
POWER CORD COLOR IDENTIFICATION

Conductor	Color	Alternate Color
Ungrounded (Line)	Brown	Black
Grounded (Neutral)	Blue	White
Grounding (Earth)	Green-Yellow	Green-Yellow

The 1480-Series Waveform Monitor has a 3-wire cord with a 3-terminal polarized plug for connection to the power source and earth ground. The earth ground terminal of the plug is directly connected to the metal chassis

Unpacking and Incoming Inspection—1480-Series (SN B060000-up)

If a 3- to 2-wire adapter is used to connect the 1480-Series to a 2-wire ac power system, be sure to connect the ground lead of the adapter to a conductor that connects to earth ground. Failure to complete the grounding system may allow the metal parts of this instrument to be elevated above ground potential and create a shock hazard.

Damage Inspection

After carefully removing the 1480-Series Waveform Monitor from the shipping carton, inspect the instrument for possible damage incurred during shipment. Report any shortage or damage to the carrier.

Save the shipping carton and packing material in case you need it to repackage the instrument for shipment.

Included Accessories List

A complete listing of accessory items that are shipped with the various 1480-Series models can be found following the Replaceable Mechanical Parts list near the rear of this manual. The graticule (or scale) items that follow are part of the listing under Standard Accessories. They are also listed here as a convenience to the user.

The following crt scale is shipped with all 1480-Series Waveform Monitors:

Qty.	Description	Tektronix Part No.
1	Scale, crt: Blank	331-0393-00

The following graticules are supplied according to the 1480-Series configuration:

Qty.	Description	Tektronix Part No.
1	CCIR Composite (1481, 1482, 1485 Opt 3 & 1485C Opt 5)	331-0393-02
1	CCIR K-Factor, visual (1481 & 1485)	331-0393-05

Qty.	Description	Tektronix Part No.
1	CCIR K-Factor, photo (1481 & 1485 except Opt 3)	331-0393-07
1	NTSC Graticule A, visual (1485 & 1480 Opt 3)	331-0393-08
1	NTSC Graticule B, visual (1480 & 1485)	331-0393-09
1	NTSC Graticule A, photo (1485 except Opt 3)	331-0393-10
1	NTSC Graticule B, photo (1480 & 1485 except Opt 3)	331-0393-11

Optional Accessories

A variety of optional accessories, for use with 1480-Series Waveform Monitors, is available from Tektronix, Inc. The following, available through the nearest Tektronix Field Office or sales representative, are the most commonly used optional accessories:

Description	Tektronix Part No.
BNC Elbow, male to female	103-0031-00
BNC "T" Connector	103-0030-00
75 Ω 42-inch Cable, BNC Connectors	012-0074-00
75 Ω 300-inch (25 ft) Cable, BNC Connectors	012-0157-00
75 Ω End-Line Termination, BNC Connectors	011-0102-00
75 Ω Feed-Thru Termination, BNC Connectors	011-0103-02

Detailed descriptions and pictures of these and other optional accessories are in the Tektronix Television Products Catalog.

QUICK OPERATIONAL CHECK

It is possible to determine if the functions of the 1480-Series Waveform Monitor are operational without employing a full-fledged Performance Test. This check cannot take the place of the Performance Test that occurs later in this Instruction Manual.

An accurate video signal, with test signals in the vertical interval, is all that is required to determine if the basic display functions of the 1480-Series Waveform Monitor are operational. The source of this signal may be either a live video feed (with ITS or VITS) or a television signal generator, such as the 149A NTSC Test Signal Generator, 148 PAL or 148-M PAL-M Insertion Test Signal Generator.

The test methods outlined here are covered in detail in Television Products Application Notes 11, 12, and 20. Copies of these Application Notes are in Section 3 of this Instruction Manual.

Best results will be obtained when a composite test signal, either full field (if available) or vertical interval, is used. This procedure is not a complete performance test, but is a useful tool in determining if the waveform monitor is partially or totally operable.

Section 5 of this manual contains a thorough performance test, which should be used for incoming inspections or determining accuracy of calibration.

Hookup: Connect a video signal to the A VIDEO INPUT connector. Terminate (75 Ω) the other (loop-thru) connector.

1. Vertical Gain and Calibrator

Depress all dark gray pushbuttons. Set vertical INPUT to a A DC, VOLTS FULL SCALE to 1.0 and RESPONSE to FLAT. Adjust INTENSITY, FOCUS and SCALE ILLUM for a comfortable viewing level with the SCALE ILLUM knob pushed in.

While keeping the OPER pushbutton in, depress the CAL pushbutton. Check for the display in Fig. 1-2.

Leave both the OPER and CAL pushbuttons in and depress the SYNC TIP pushbutton. Check for the display in Fig. 1-3.

Push down the OPER pushbutton; this releases the CAL pushbutton. Adjust the front panel GAIN screwdriver adjustment, if necessary, for a 1 volt peak-to-peak or 140 IRE amplitude display.

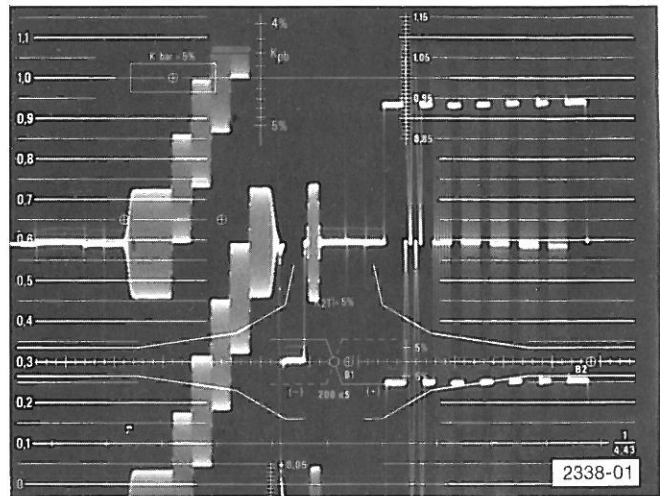

Fig. 1-2. Overlaid levels at backporch.

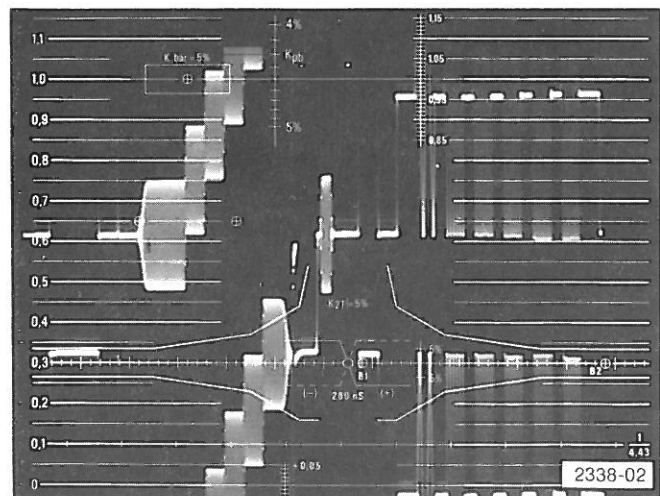

Fig. 1-3. Overlaid levels at sync tip.

2. Vertical Attenuation

Change VOLTS FULL SCALE to 0.5 and vertically position the display so that the sync pulse amplitude can be measured. It should be double the amplitude seen with the VOLTS FULL SCALE at 1.0.

Adjust the VAR VOLTS FULL SCALE for a sync pulse amplitude equal to that observed at 1.0 VOLTS FULL SCALE. Change VOLTS FULL SCALE to 0.2 and check for sync pulse amplitude 2.5 times greater than the amplitude set with the variable control. See Fig. 1-4.

Return VAR to its detented position and set the VOLTS FULL SCALE to 1.0.

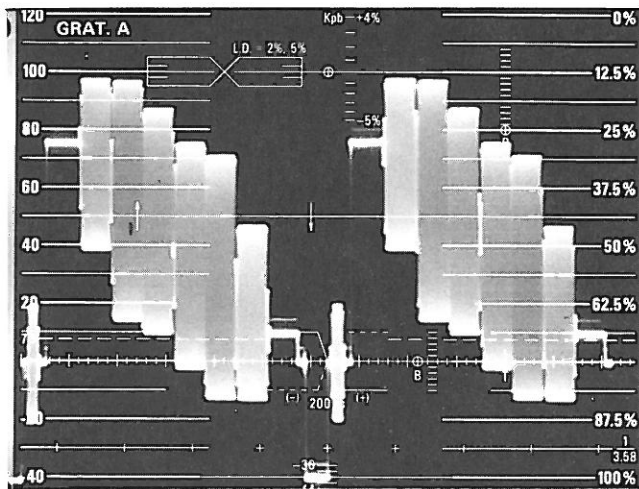

a.

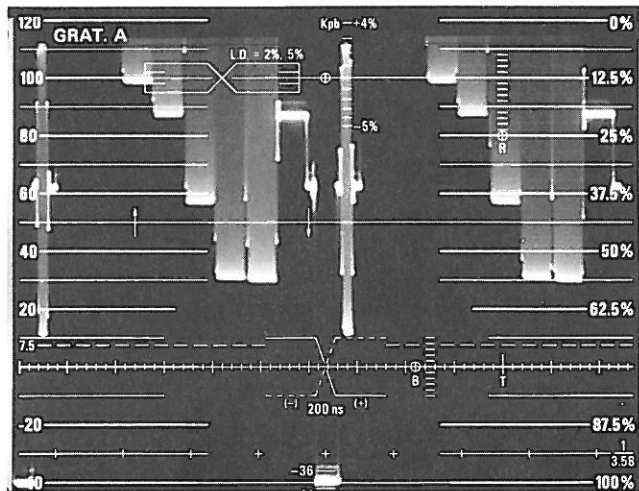

b.

2338-03

Fig. 1-4. Sync amplitude measurement, a. normal, b. 2.5X increased.

3. DC RESTORER

Depress the DC RESTORER OFF pushbutton and position the display so that the baseline is at the blanking level (300 mV or 0 IRE).

Push in the FAST DC RESTORER and note a rapid shift to a new average level.

Turn off the DC RESTORER (OFF).

Push in the SLOW DC RESTORER and note rapid shift followed by a slow change to a new average level.

Depress the SYNC TIP pushbutton and check for a change in the average level.

4. RESPONSE SWITCH

This step is written using a composite test signal; however, RESPONSE positions can be checked with any of the normally available test signals. Fig. 1-5a is an NTSC Composite Test Signal.

a. LOW PASS: Switch the RESPONSE to LOW PASS and note that all subcarrier and corners of fast transitions are lost. See Fig. 1-5b.

b. LUM or IRE: Switch the RESPONSE to LUM (IRE) and note that most subcarrier is lost but the corners of the fast transitions are retained. See Fig. 1-5c.

c. FLAT: Switch the RESPONSE to FLAT and note an undistorted presentation of the composite test signal, Fig. 1-5d.

d. BANDPASS (4.43 or 3.58): Switch the RESPONSE to BANDPASS and note that only the subcarrier information is presented. See Fig. 1-5e.

e. DIFF'D STEP: Switch the RESPONSE to DIFF'D STEP and note that each transition is now represented as a spike. See Fig. 1-5f.

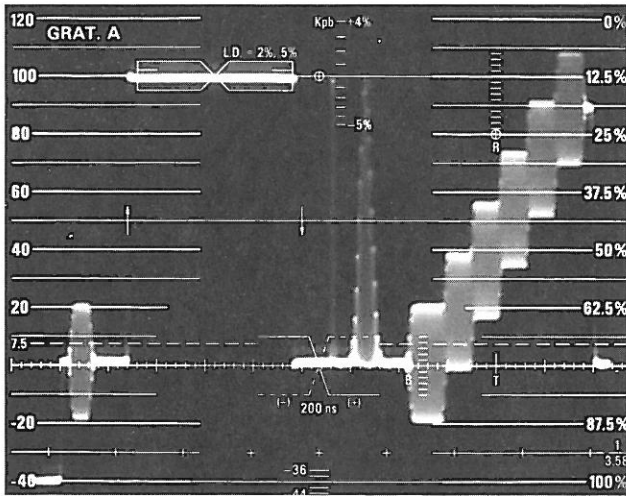

a.

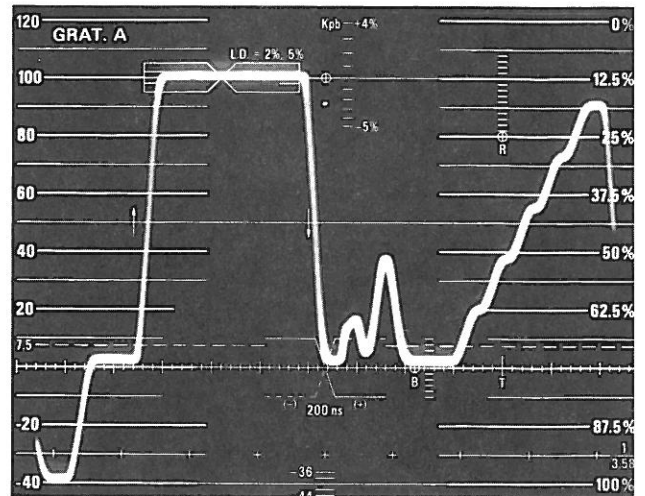

b.

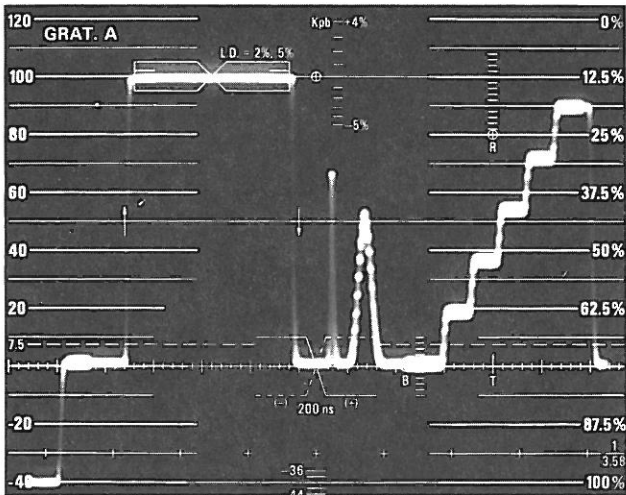

c.

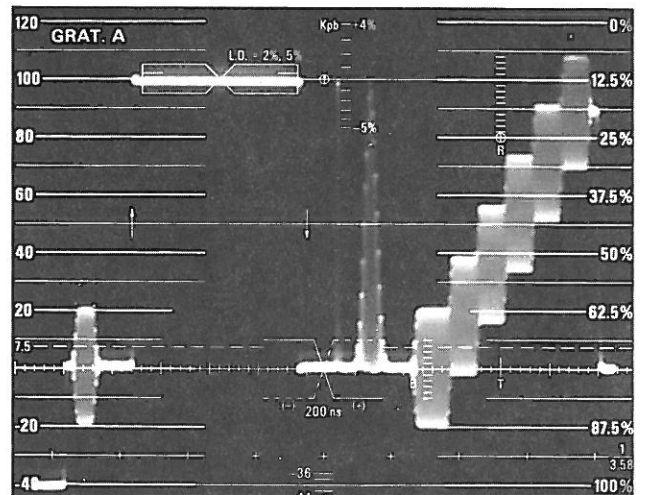

d.

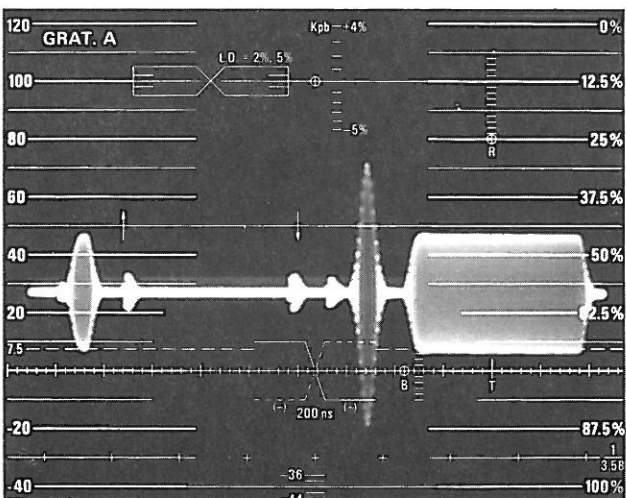

e.

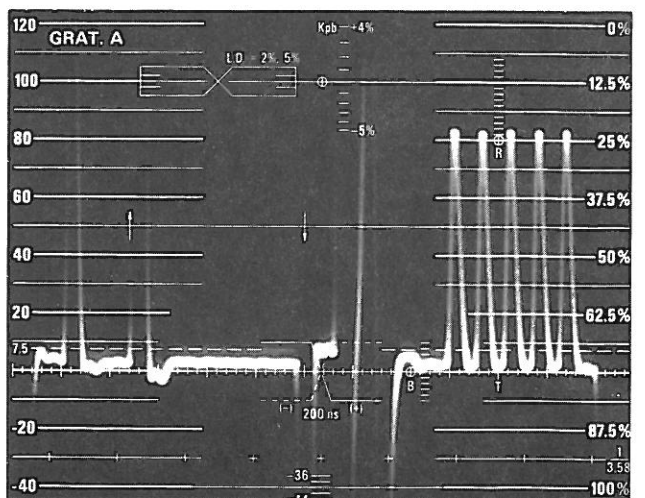

f.

2338-04

Fig. 1-5. Effects of the various filters on a Composite Test Signal. a. Applied signal, b. Low Pass filter, c. IRE (NTSC) or Lum (PAL), d. Flat, e. Bandpass, f. Diff'd Step.

5. WAVEFORM COMPARISON

Turn the larger (OVERLAY) knob out of the switch detent, note that the WAVEFORM COMPARISON light comes on.

Rotate the smaller (LOCATE) knob back and forth slowly and note a small break in the trace and moves back and forth with the rotation of the LOCATE knob. Position the break between the pulse and bar components of the composite test signal.

With the OVERLAY control, position the right side of the display so that the pulse lines up directly under the bar. See Fig. 1-6.

Return the OVERLAY control to the detented position.

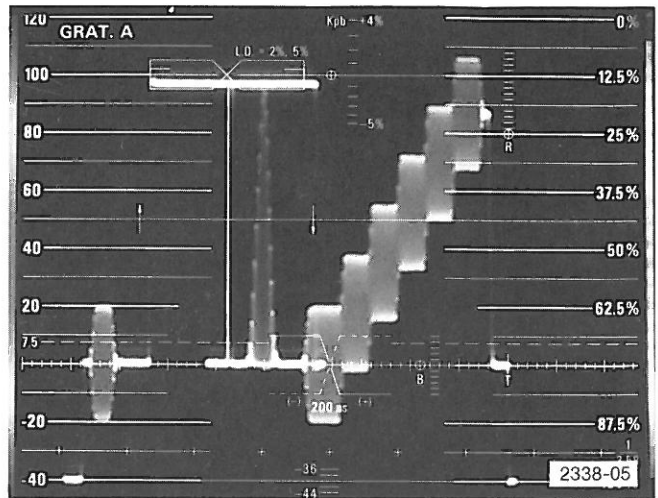
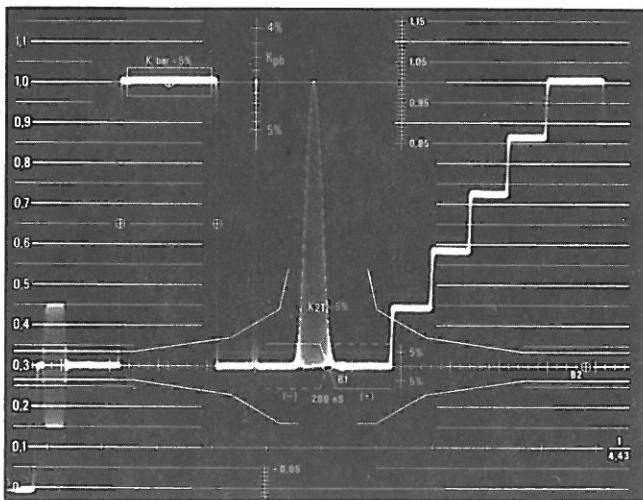
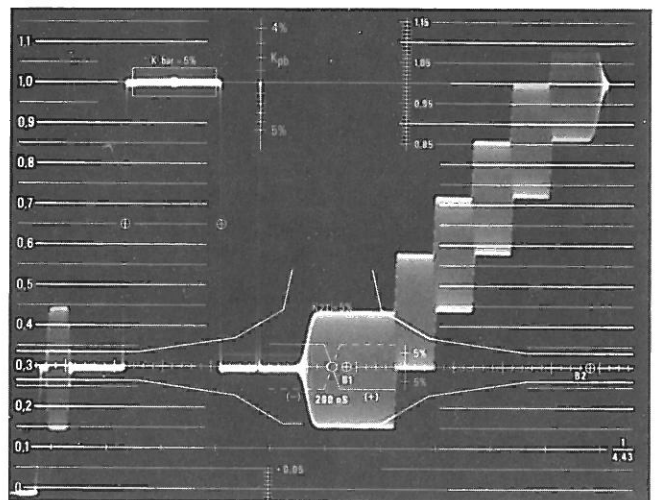

Fig. 1-6. Waveform Comparison overlayed pulse and bar signal.



a.



b.

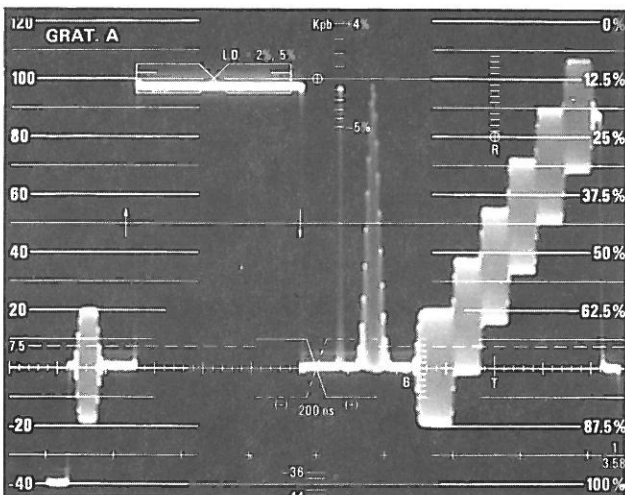

c.

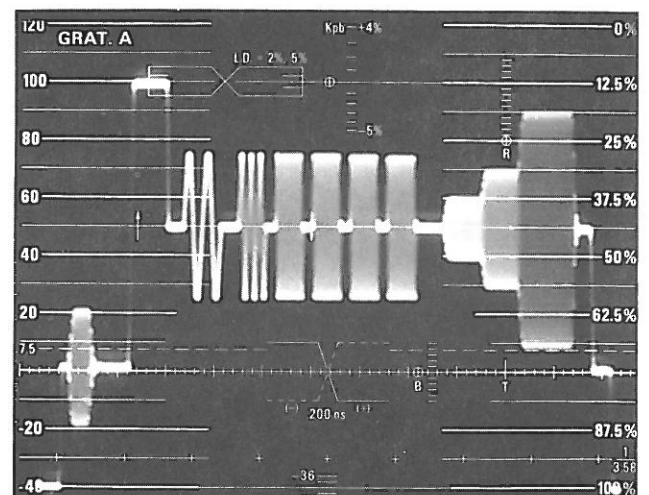

d.

2338-06

Fig. 1-7. Test Signals that can be found in the vertical interval. a. Line 17 International Test Signal (Europe), b. Line 330 International Test Signal (Europe), c. NTSC Composite Test Signal (Line 17, Field 1), d. NTSC Test Signal (Line 17, Field 2).

6. LINE SELECTOR

These tests require that the operator know on what vertical interval lines the test signals (VITS or ITS) have been inserted.

a. DIGital: Push the DIG and correct FIELD buttons, rotate the LINE SELECTOR switch until a line known to carry a test signal is selected. For example, line 17 or 330 in the PAL color system. Check that the test signal is correct for the field and line selected. See Fig. 1-7a through 17d.

b. VARIABLE: Depress the VAR pushbutton and rotate the VAR LINE SELECTOR through its range and check that both vertical interval and picture area line can be displayed.

c. 15 LINES: Push the 15 LINES button and rotate the VAR LINE SELECTOR from end to end and find a display that has picture information and vertical interval lines, including test signals. See Fig. 1-8.

d. ALL FIELDS: Push the DIG pushbutton and select line 17 (17 & 330). Depress the ALL FIELDS pair and observe overlaid test signals. See Fig. 1-9.

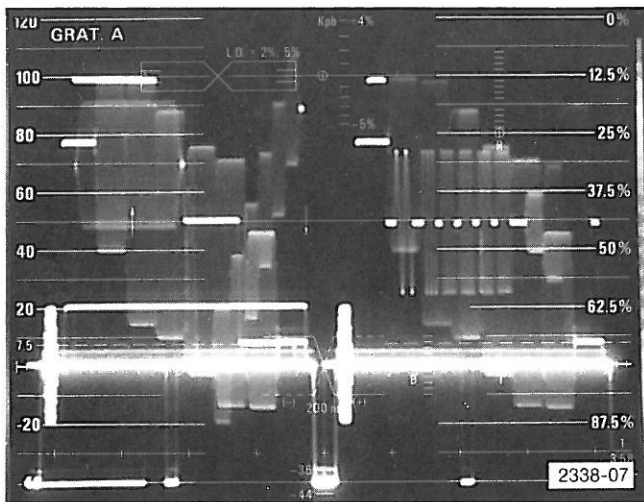
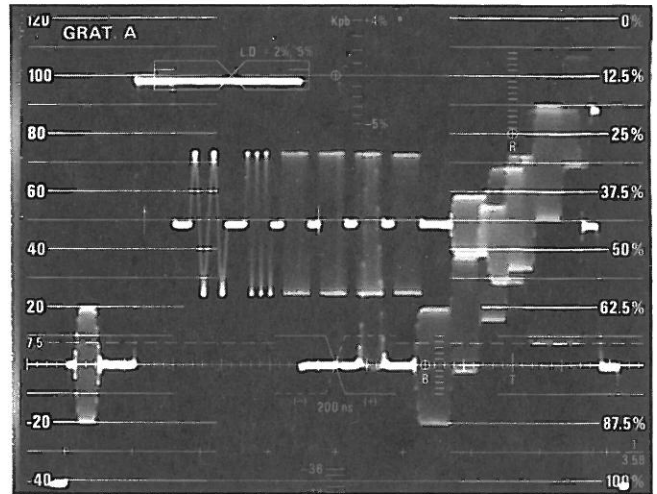
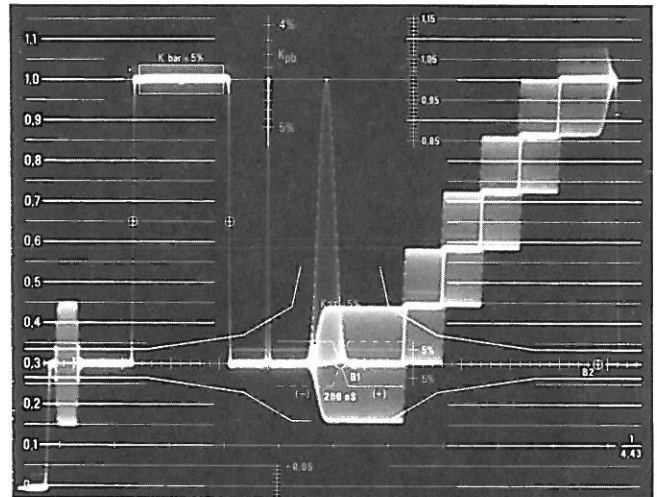

Fig. 1-8. 15-Line display with both active and vertical interval lines.



a.



b.

2338-08

Fig. 1-9. All Fields display of test signals that are inserted in the vertical blanking interval. a. NTSC line 17 both fields, b. PAL lines 17 and 330 (overlaid).

7. DISPLAY SELECTION

a. 2 FIELD: Change the DISPLAY to 2 FIELD. Depress the LINE SELECTOR OFF pushbutton. Check for a full 2-field display, including part of the first vertical interval. See Fig. 1-10.

b. 10 μ S/DIV: Change the DISPLAY to 10 μ S/DIV and check for a 2-line display. See Fig. 1-11.

c. 5 μ S/DIV: Change the DISPLAY to 5 μ S/DIV and check for a 1-line display. See Fig. 1-12.

NOTE

The EXTERNAL position of the 1480-Series DISPLAY switch is inactive (unless an internal circuit change is made); therefore, it is not looked at while these familiarization steps are performed.

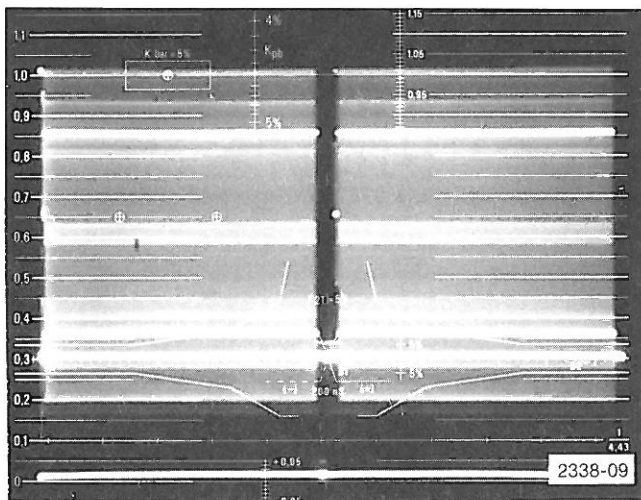

Fig. 1-10. 2-field display.

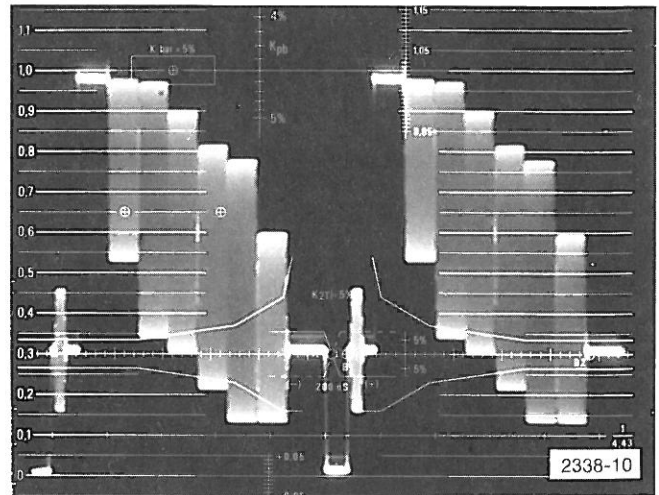

Fig. 1-11. Two-line display of test signal, 10 μ S/Division.

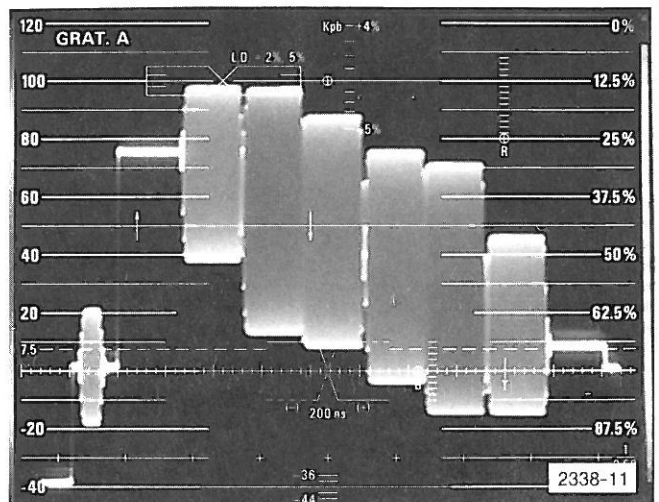
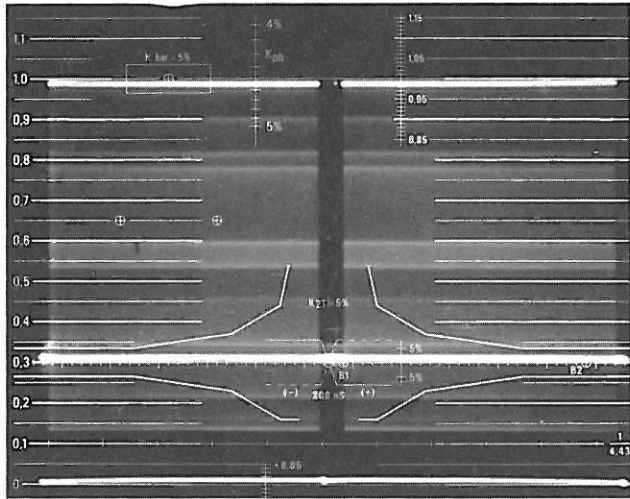

Fig. 1-12. A one-line display of a test signal at 5 μ S/Division.

8. MAGNIFIER

a. Fixed MAGNIFIER: Set the DISPLAY to 2 FIELD and the MAGNIFIER to 1, use the HORIZONTAL POSITION to place the vertical interval at graticule center. See Fig. 1-13a. Rotate the MAGNIFIER through its settings and check for a display similar to each of those in Fig. 1-13a through 1-13f.



a.

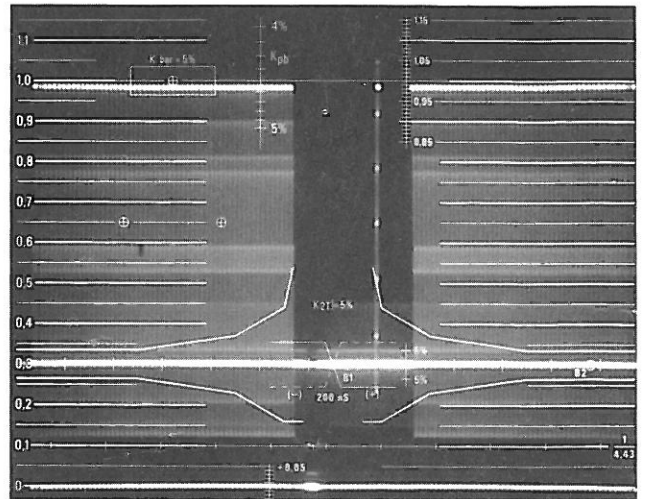

b.

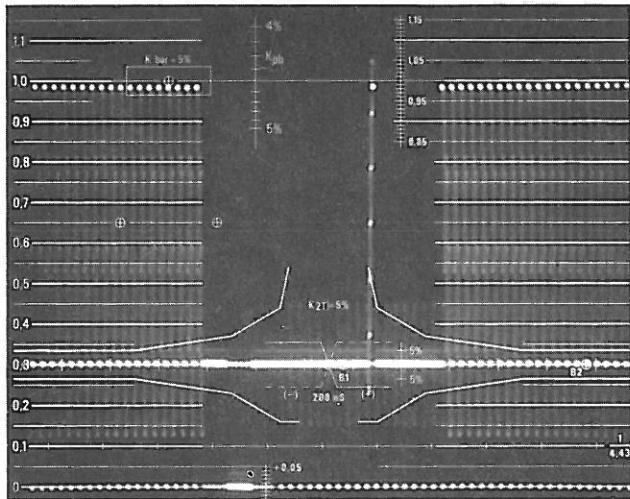

c.

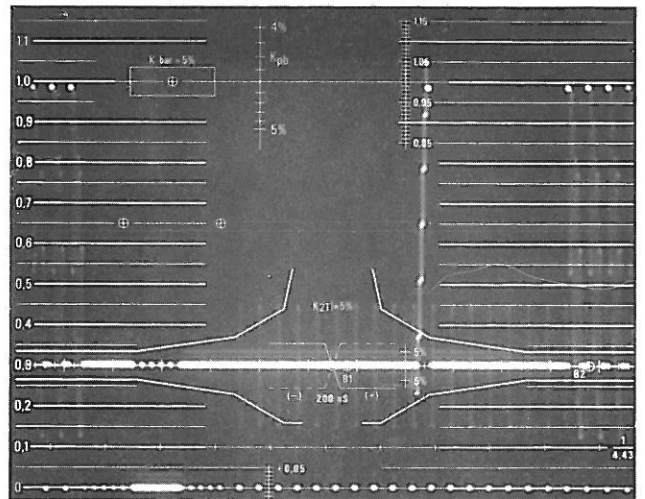

d.

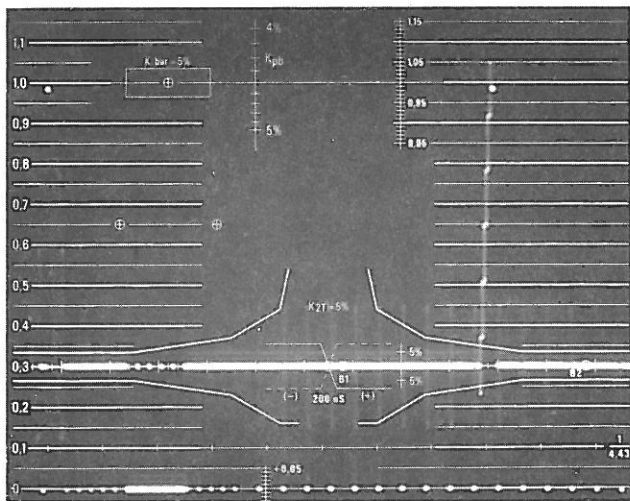

e.

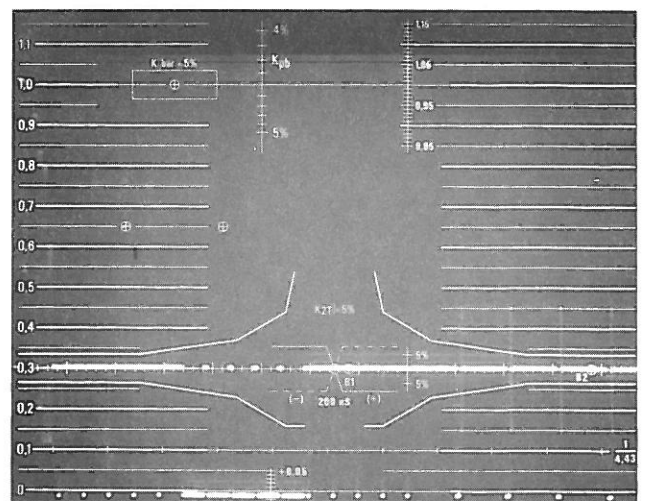

f.

2338-12

Fig. 1-13. Magnified Sweep a. X1, b. X5, c. X10, d. X20, e. X25, f. X50.

Unpacking and Incoming Inspection—1480-Series (SN B060000-up)

b. VARIable MAGNIFIER (1481, 1482, & 1485 only): Set the MAGNIFIER TO X1 and the DISPLAY to $10 \mu\text{s}/\text{DIV}$. See Fig. 1-14. Rotate the VARIable MAGNIFIER back and forth to check its total range. Change in duration of one line from less than $1/2$ scale/line to greater than $1/2$ scale/line. See Fig. 1-14.

This procedure has only covered the standard instrument; if the instrument being looked at contains any options, it will be necessary to consult the Performance Verification Procedure (Section 5) for familiarization.

REPACKAGING INSTRUCTIONS

The 1480-Series shipping carton provides maximum instrument protection during shipment. If reshipment becomes necessary, repackaging the instrument in its original carton will minimize the danger of damage during shipment. Figure 1-15 and 1-16 show how to repackage the instrument.

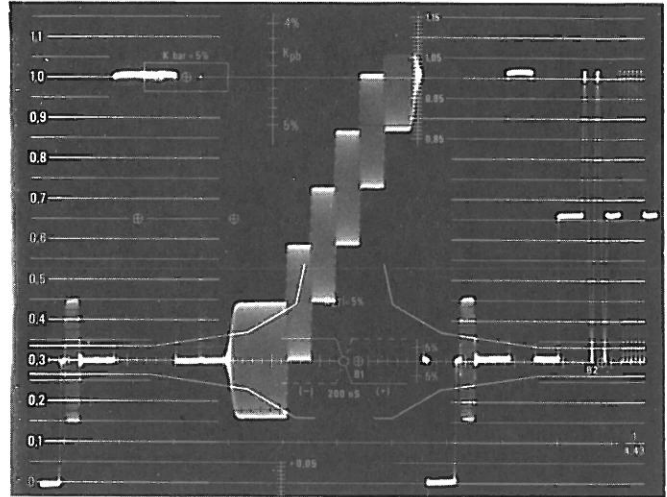

a.

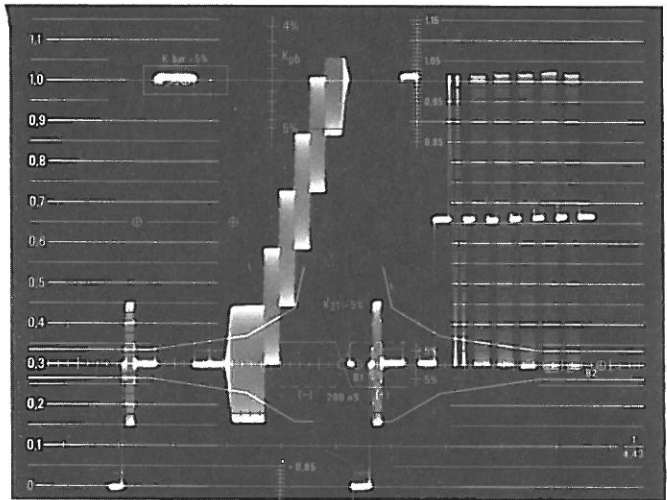

b.

2338-13

Fig. 1-14. Variable Magnifier (1481-1482-1485 only) a. Greater than 1, b. Less than 1.

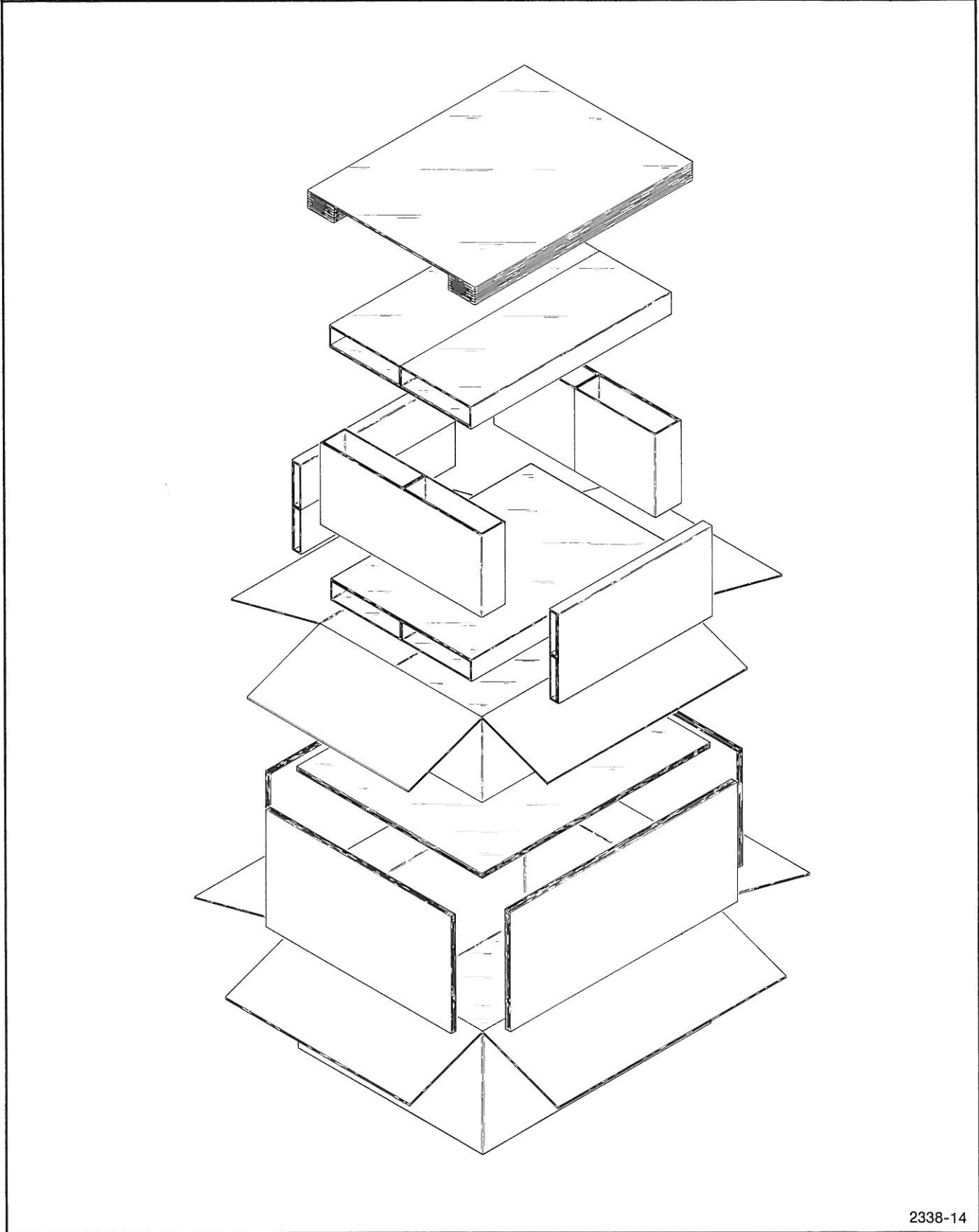

2338-14

Fig. 1-15. 1480-Series Rackmount packaging.

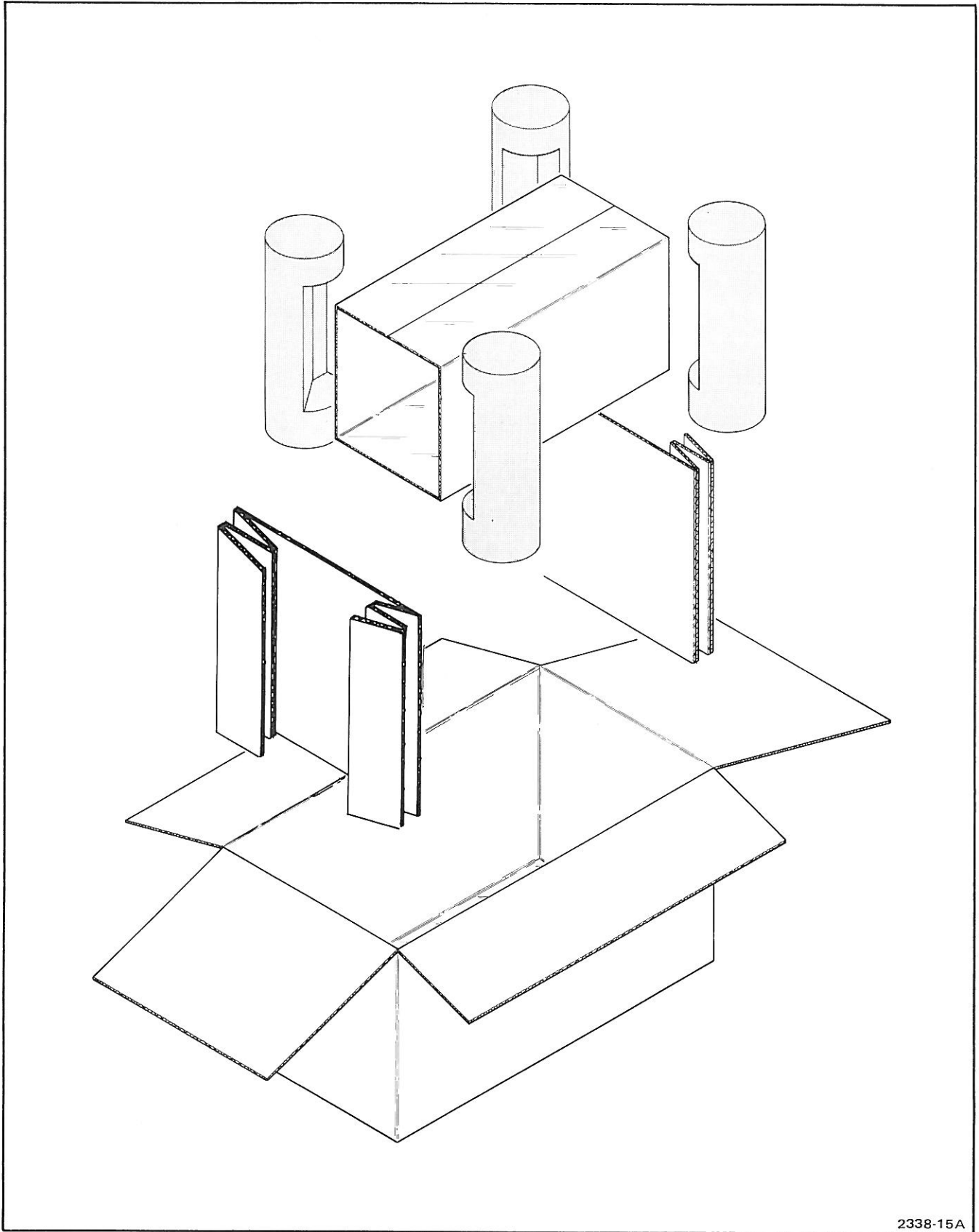

2338-15A

Fig. 1-16. 1480-Series Cabinet model packaging.

OPERATING INSTRUCTIONS

The 1480-Series of Television Waveform Monitors prove a combination of high performance and versatility. They can be single-standard models or dual-standard combinations, available for most of the world's operating television systems.

1480-Series are available in either cabinet or rackmount configurations, designed for use in control rooms, video tape installations or transmitter plants.

Many catalog options are available to closely tailor a 1480-Series Waveform Monitor to specific measurement applications.

FEATURES

Vertical

A distortion-free, vertical overscan capability offers increased high-resolution measurements. Coupled with a wide vertical positioning range, any portion of a nominal 1-volt composite video signal can be viewed at any position of the VOLTS FULL SCALE settings.

The vertical response can be specialized by selecting one of several filters from the front panel, ranging from LOW PASS, through IRE and FLAT, to BANDPASS around certain color subcarrier frequencies. In addition, the same switch can select a differentiated-steps display or an auxiliary video input at the rear panel.

A versatile DC Restorer offers clamping on the back porch or at the sync tip of the composite video waveform. Fast and slow clamping speeds can be selected to suit specific needs.

An internal calibration squarewave is available at the push of a button. This calibration signal can also be used to offset the displayed video signal for quick amplitude accuracy checks.

Catalog Option 1 provides an ac-coupled probe input to the vertical channel. Operating instructions are covered later in this section.

Horizontal

Calibrated magnification to X50 and a high writing-rate crt allow viewing of fast-rise, low repetition-rate signals such as the 100 ns risetime of a test signal on a single line out of the four fields in the PAL system. In high-magnification positions, the crt is automatically brightened.

"Timebase Foldback", a waveform comparison feature, provides for locating and overlaying a portion of a line-rate display with another portion of the same display. For instance, in measuring pulse-to-bar ratio, the pulse can be displayed directly beneath the center of the bar.

The horizontal display can be any of the following:

- 1) Digitally-selected line (or two lines, depending on sweep speed selected.)
- 2) Continuously variable selection of line (or two lines).
- 3) 2 fields (fields 1 and 3 or 2 and 4 for NTSC).
- 4) One brightened line from 2 fields (or two brightened lines).
- 5) 15 lines—either brightened (from 2 fields) or superimposed on one another at line rate. Continuously-variable selection of the 15-line group is provided.
- 6) (Option 7 only). Slow Sweep (4 to 12 seconds/sweep).
- 7) All fields—permits simultaneous viewing of one line (or a group of lines) from each field.
- 8) External—signal at external horizontal input is displayed. (This mode is normally shipped disabled to avoid burning the cathode-ray tube. An internal jumper must be moved to enable. See note on diagram 9.)

Direct-acting Sync follows horizontal jitter, so that jitter is not displayed; the AFC mode displays any horizontal jitter.

Rear Panel

The main video and external sync signal inputs are of loop-thru design (no internal termination) and can be isolated from the chassis, allowing for differential rejection of hum by the input stages. Input connectors are available for RGB displays and external horizontal inputs along with an auxiliary video input to the vertical amplifier. Output connectors supply auxiliary video out, a picture monitor video signal, and a line strobe pulse coincident with the setting of the Line Selector Variable control, and the digital Line Selector.

Also available is a connector mounting location for customized, remote-operating installation.

Operating Instructions—1480-Series (SN B060000-up)

Graticules

The graticule most applicable in the television system for which a particular model is intended is supplied internal to the crt. Also included as standard accessories are several external graticules, usually intended for specific measurements, or to convert dual-standard models from one line standard to the other. A blank crt is available as an option.

External graticules are available in both NTSC and CCIR configurations in two pattern sizes. One, intended for normal viewing use, is the same pattern size as the internal graticule.

The second pattern size is slightly smaller than the internal pattern and is designed to remove parallax effects when using an oscilloscope camera.

CONTROLS

Some of the pushbuttons on the front panel are color-coded dark gray. With all these buttons pushed in, the waveform monitor display will be normal according to the vertical response mode selected. All pushbuttons have functional labels. Within their own groups, the buttons are self-cancelling when pushed individually. In certain operating modes, the OPER and CAL button-pair will be pushed in at the same time, as well as pairs of the FIELD buttons.

Almost all of the functions, controls, connectors, and indicators needed and used by any of the models in the series are present on the 1485 NTSC/PAL dual-standard instrument. Therefore, the 1485 is used as the example to illustrate and describe the features of the 1480-Series of Waveform Monitors.

Controls listed in the following are referenced to Fig. 2-1.

1. **POWER**—Applies or removes mains voltage to the power transformer primary.

2. **POWER ON**—Lights to indicate presence of mains voltage at power transformer primary.

3. **SIGNAL**—Lights indicate 50 Hz or 60 Hz field-rate input signal. (1485 only).

4. **INPUT**—Selects A or B VIDEO INPUTS, or A-B differentially, ac or dc coupling, and the X10 PROBE INPUT if the waveform monitor is equipped with Option 1.

5. **VOLTS FULL SCALE**—Alters vertical gain allowing 1.0, 0.5, or 0.2-volt signals to produce full screen deflection. Also acts as a vertical magnifier providing X2, or X5 expansion of the input signal.

6. **VAR VOLTS FULL SCALE**—Varies vertical gain from X0.5 to X1.4 nominal (−6 dB to +3 dB) when not in the CAL detent position.

7. **UNCAL**—Lights up to indicate the VAR VOLTS FULL SCALE control is not in CAL.

8. **RESPONSE**—Selects wide-band, filtered, or differentiated vertical response modes. Also selects auxiliary video input from rear panel.

LOW PASS: Attenuates frequencies 500 kHz and up by at least 14 dB (−40 dB at 1 MHz typical).

IRE: Conforms to IRE standard 23S-A, 1958 (−22 dB at 4.43 MHz typical). 1480C and 1480R only.

FLAT: Unfiltered, wide-band position. Flat to 5 MHz or more, −3% at 10 MHz.

4.43 BANDPASS: Provides bell-shaped response curve with 4.43 MHz as center frequency. Within 1% of FLAT reference at 4.43 MHz.

3.58 BANDPASS: Provides bell-shaped response curve with 3.58 MHz as center frequency. Within 1% of FLAT reference at 3.58 MHz.

DIFF'D STEP: Differentiates risers of linearity test signals, providing amplitude comparisons of staircase step risers. Automatically increases vertical gain to maximum (between 5 and 7 times). Attenuation increases from about −2 dB at 0.5 MHz to about −40 dB at color subcarrier center frequencies. Dc restoration not effective in this mode.

AUX VIDEO IN: Provides unfiltered, wide-band input to the vertical amplifier. The response characteristics are the same as FLAT.

Operating Instructions—1480-Series (SN B060000-up)

9. DC RESTORER—Eliminates vertical drift and provides stable displays despite changes in signal amplitude and average luminance levels. Buttons select the clamping speed and clamping location on the composite video signal. In the DIFF'D STEP response mode, the dc restoration is automatically turned off. In the LOW PASS response mode, SYNC TIP is automatically locked out. In the BANDPASS response modes, the dc restorer circuits still operate, but, because the filters do not pass dc or a low-frequency component, dc restoration neither adds to, nor detracts from, measurements made with these filters.

OFF: Disables the dc restoration circuits. The trace level will follow the dc content of the incoming signal.

SLOW: Selects a time-constant long enough to display mains hum and field-rate tilt in the video signal.

FAST: Selects instantaneous clamping to eliminate hum and tilt in the display. Attenuates mains hum at least -26 dB.

BACK PORCH: Sets the clamping sample pulse to occur at back-porch time in the composite video waveform.

SYNC TIP: Sets the clamping sample pulse to occur at sync-tip time in the composite video waveform.

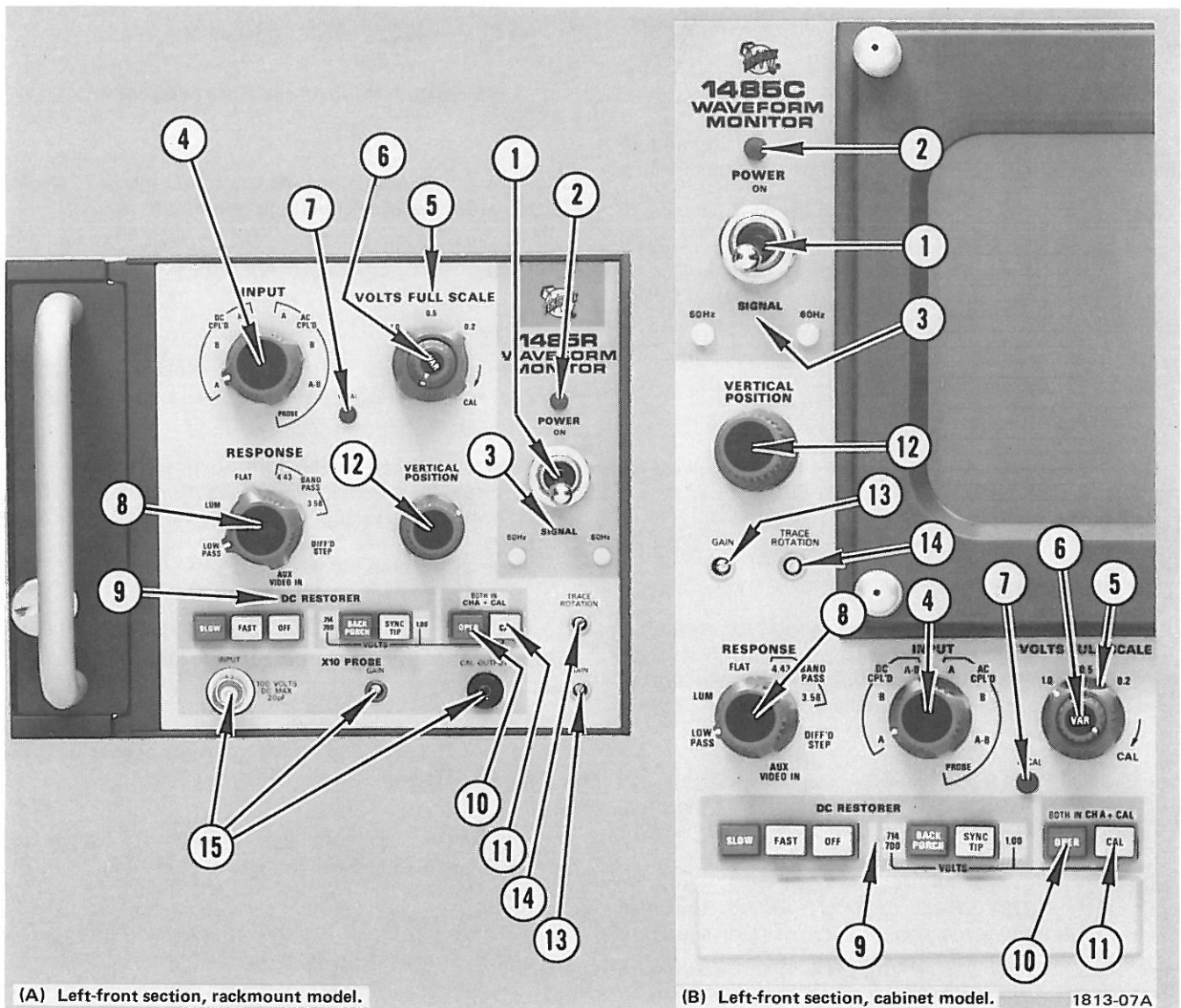

Fig. 2-1. Vertical control locations for rackmount, left, and cabinet model, right.

Operating Instructions—1480-Series (SN B060000-up)

10. OPER—Selects the INPUT signal for normal display operation.

11. CAL—Selects an internally-generated squarewave useful for checking vertical gain and the complete or component parts of a composite video signal.

When CAL is pushed in at the same time as the OPER button, the incoming signal (at the A Input only) is overlaid on the two levels of the calibrator squarewave for quick and accurate evaluation of the video signal amplitude.

The Calibrator signal amplitude is dependent on the DC Restorer settings; Sync Tip 1 V; Back Porch 700 mV or 714 mV, depending further on which line-standard external graticule is being used.

12. VERTICAL POSITION—Provides positioning in the vertical direction with a ten-turn potentiometer.

13. GAIN—Adjusts amplitude of the displayed signal with the VARIABLE VOLTS FULL SCALE control in the CALibrated (detent) position. This is usually adjusted by comparing the internal calibrator signal with the calibrated internal graticule.

14. TRACE ROTATION—Aligns the display with the horizontal graticule lines.

15. OPTION 1

X10 PROBE INPUT—Bnc connector for use with an external high-impedance, X10 probe. Input amplifier has a gain of 10X to compensate for the probe's attenuation; a one-volt signal through the X10 probe will appear as one volt on the crt.

X10 PROBE GAIN—Adjusts the gain of the probe amplifier.

X10 PROBE CAL OUTPUT—When the CAL pushbutton is depressed, a 1 V calibrator signal, for compensating the X10 probe, is available.

Controls listed in the following are referenced to Fig. 2-2.

16. DISPLAY—Selects the calibrated sweep rates, and horizontal input mode in standard instruments. In instruments that contain Option 7, the DISPLAY switch has two extra positions, Slow Sweep -Polarity and Slow Sweep +Polarity.

2 FIELD: Displays two fields at 25 Hz or 30 Hz frame rates. Sweep starts at line 16 of the vertical interval of the field or field-pair selected by FIELD switch.

10 μ s/DIV: Selects sweep rate to effectively display two line periods of either 525-line or 625-line systems (The graticule horizontal scale is marked for 12.7 div or 127 μ s. In 525-line systems, a two-line period equals 127 μ s; in 625-line systems a two-line period equals 128 μ s.

5 μ s/DIV: Selects sweep rate to effectively display one line-period of either system.

EXT: Selects the external horizontal input for display.

Normally shipped disabled to protect the cathode-ray tube. Internal wiring change is required to activate.

SEE NOTE ON DIAGRAM 

OPTION 7

SLOW SWEEP \pm TRIG PLRT—Selects Slow Sweep and the triggering polarity for sweep origin.

SLOW SWEEP VAR—Controls slow sweep rate over a range of approximately 4 to 12 seconds/sweep. Whenever slow sweep is selected and the trace is not on the screen, a red indicator lamp, that is part of the Waveform Comparison circuit, will be lit.

17. MAG μ s/DIV—Overrides DISPLAY switch to select other sweep deflection factors. Display brightness is automatically increased to maintain balanced displays.

OFF: Selects normal sweep modes controlled by DISPLAY switch.

X5, X10, X20, X25, X50: Magnifies 2 FIELD and EXTERNAL displays accordingly.

1, .5, .25, .2, .1: Overrides 10 μ s/DIV or 5 μ s/DIV modes to provide indicated calibrated sweep speeds.

VAR (1481, 1482, and 1485 only)—Extends the effective range of the fixed magnifier positions.

18. HORIZONTAL POSITION—Moves display horizontally with a ten-turn potentiometer. This has sufficient range to display both ends of the sweep at 50 times magnification.

19. FIELD—Positively selects the beginning of the 2 FIELD sweep. Buttons select individual fields 1, 2, 3, or 4 for PAL systems, or EVEN (fields 1 and 3) or ODD (fields 2 and 4) field pairs for NTSC systems.

Simultaneously pressing FIELD 3 and 2 buttons and any LINE SELECTOR function selects all fields to be time overlaid.

During the ALL FIELDS mode, the horizontal sweep is only one field-period long. The LINE SELECTOR VARIABLE control cannot be used to select lines or groups of lines that belong in the second field of a normal 2 FIELD display.

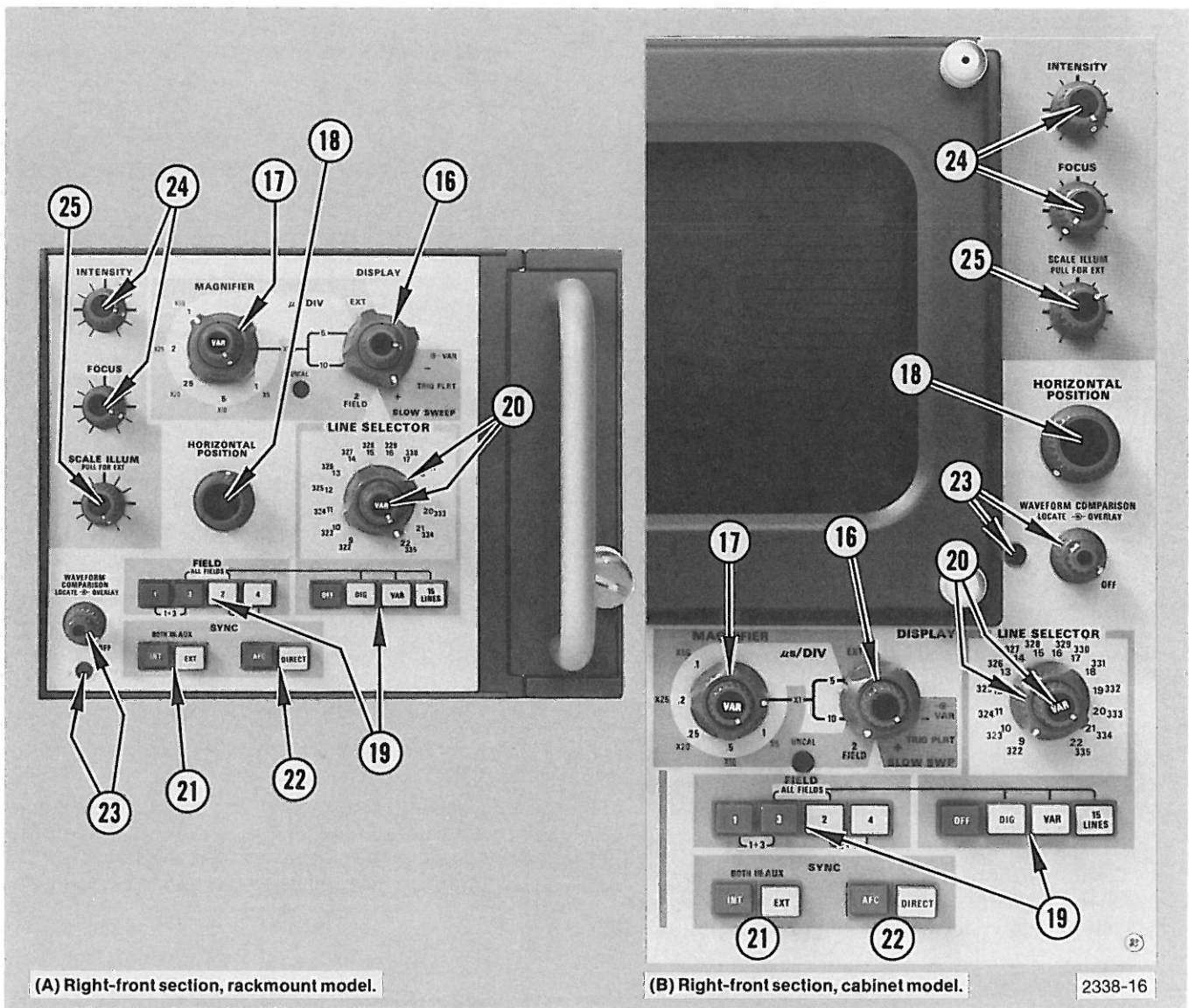

Fig. 2-2. Horizontal control locations for rackmount, left, and cabinet model, right.

Operating Instructions—1480-Series (SN B060000-up)

20. LINE SELECTOR—Provides three modes of line selection to view any line in any field. The line or lines selected are intensified in the 2 FIELD display. The dark gray OFF button turns the LINE SELECTOR off.

DIG: Provides positive, digitally-controlled line selections from the vertical interval of selected fields to start the line-rate sweeps. Selects the ninth through the twenty-second line of each field.

VAR: Selects single lines from the displayed fields with a multi-turn potentiometer. While in the 2 FIELD mode, the selected line is intensified by a bright-up strobe. When the DISPLAY switch is set to 10 μ s/DIV or 5 μ s/DIV, the display starts with the selected line.

15 LINES: Performs the same as the VARIable mode except the strobe is fifteen lines wide. In the line-rate displays, the selected fifteen lines are overlaid on each other. This is used to display head rotation of a quad-head video tape recorder.

21. IN-EXT SYNC—Selects source for Horizontal Synchronization.

INT: Derives sync information from incoming video signal that is being displayed.

EXT: Derives sync information from composite signals applied to the rear panel (A) or (B) input.

22. AFC-DIRECT SYNC—Selects sync processing.

AFC: Phase-locks the internal oscillator to incoming line sync. This mode offers more noise immunity (about 8 dB jitter-reduction) than direct. However, jitter present in the signal can be seen more readily in AFC mode.

This mode displays every line of incoming video, including those with missing sync pulses (at least ten consecutive lines before loss of lock). As long as the incoming line frequency is within 200 Hz of 15,750 Hz, the phase-locked loop will provide a stable display. Otherwise, the sweep free-runs.

DIRECT: Provides a triggered display for every sync pulse received. This mode will operate on low rep-rate signals and up to 20 kHz line frequencies.

This mode will not display lines with missing sync pulses. After a long period of time without a trigger reference, sweep control will revert to the internal oscillator and free-run until a new sync pulse arrives.

23. WAVEFORM COMPARISON—Selects a time-overlay mode in the 10 μ s/DIV and 5 μ s/DIV sweep rates, useful for comparing most amplitudes within complex waveforms.

LOCATE: Positions the comparison break-point on the 10 μ s/DIV and 5 μ s/DIV displays, provided that the OVERLAY control is out of the OFF (detent) position. The comparison break-point, a small gap in the trace, will be positioned at the right side of the sweep when the LOCATE control is near its clockwise end.

OVERLAY: Time-overlays that portion of the sweep occurring after the break-point with the preceding part of the sweep. As the control is rotated counterclockwise, the display will overlay from right to left.

A red indicator turns on when the OVERLAY control is active.

24. INTENSITY & FOCUS—Control brightness of the beam and definition of the display.

25. SCALE ILLUM—Adjusts illumination of the internal or external graticule markings.

PULL FOR EXT: Selects lighting system for external graticules and turns off internal graticule system.

It also selects the calibrator waveform amplitude for the BACK PORCH mode of the DC RESTORER. The external graticule restrains a slide switch at its base, behind the bezel, to selecting the appropriate calibration voltage.

CONNECTORS

The following is a discussion of the various input and output connectors. In addition there are other features that are incorporated in the rear-panel configuration; they too are discussed here. All items mentioned are found in Fig. 2-3.

27. VIDEO INPUTS A & B—High impedance, loop-thru inputs for composite video. Compensated for 75 Ω , not internally terminated.

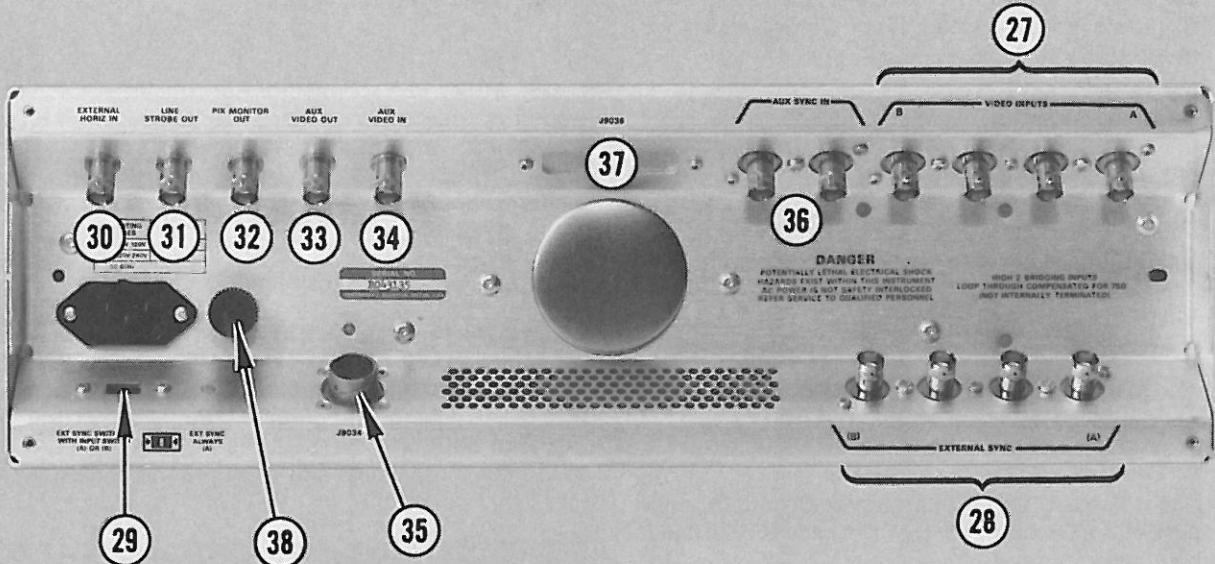

(A) Rackmount model rear panel.

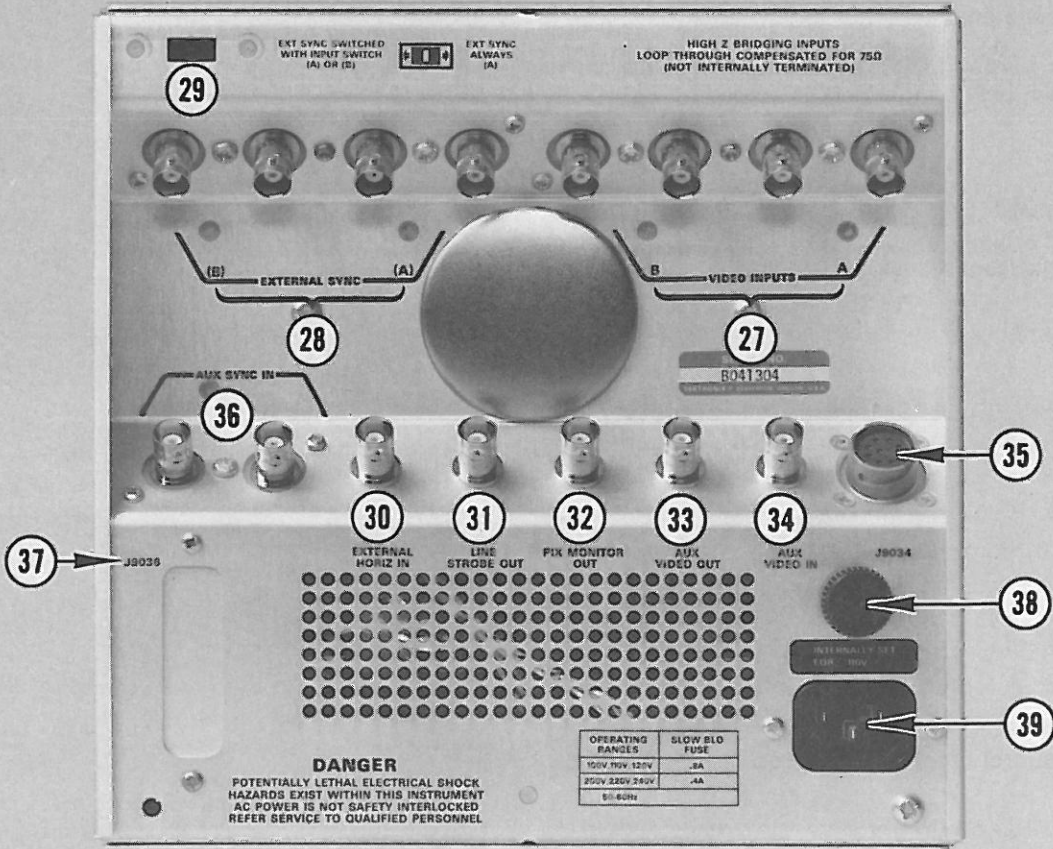

(B) Cabinet model rear panel.

2338-17

Fig. 2-3. Rear panel connectors and features for 1480-Series rackmount and cabinet models.

Operating Instructions—1480-Series (SN B060000-up)

28. EXTERNAL SYNC (A) & (B)—High impedance, loop-thru inputs for composite sync. Compensated for 75 Ω , not internally terminated.

29. External Sync Selector Switch—Selects source for external sync information.

EXT SYNC SWITCHED WITH INPUT SWITCH (A) OR (B): External sync input follows setting of the front-panel INPUT switch.

EXT SYNC ALWAYS (A): External sync input is always from the (A) input, regardless of the INPUT switch setting.

30. EXTERNAL HORIZ IN—Requires a 5-volt, positive-going input signal, starting at 0 volt, for full-screen deflection. Dc-coupled. Input impedance is 10 k Ω . No crt blanking.

Normally shipped disabled to protect the cathode-ray tube. Internal wiring change is required to activate this mode. See note on diagram 9.

31. LINE STROBE OUT—A line selector strobe pulse that is present only during Line Selector mode of operation.

32. PIX MONITOR OUT—A composite video output of incoming video signal, picked off after the vertical preamp, but before the Response filters. Line Strobe is added to the output signal in Line Selector modes of operation. Internally terminated in 75 Ω .

33. AUX VIDEO OUT—Same as PIX MONITOR OUT, except that the Line Strobe pulse is not available. Internally terminated in 75 Ω .

34. AUX VIDEO IN—Video input, internally terminated in 75 Ω . 1.5 dB gain allows for loss of passive networks that may be used. Enters the vertical system after the Response filters.

35. J9034—RGB input connector providing external switching control and signal access for RGB/YRGB displays.

36. AUX SYNC IN—This input is used in Options 4,5, and 7. An uncompensated loop-thru input used for either tone wheel sync input (Options 4 and 5) or the 50-60 Hz triggering signal (Option 7).

37. J9036—Blanking mounting location for possible remote control connector.

38. Main Fuse and Holder

39. Motor Base connector Receptacle—3-bladed connector to receive power cord. Contains an RFI filter.

GRATICULES

Patterns

Two basic patterns appear as 1480-Series internal graticules. They are the 625 line/50 Hz, K-Factor CCIR Composite combination (shown in Fig. 2-4) and a 525 line/60 Hz, Composite graticule, designated Graticule A, Fig. 2-5. Both of these patterns are available in external graticules in full scale and a 3% reduced photo version.

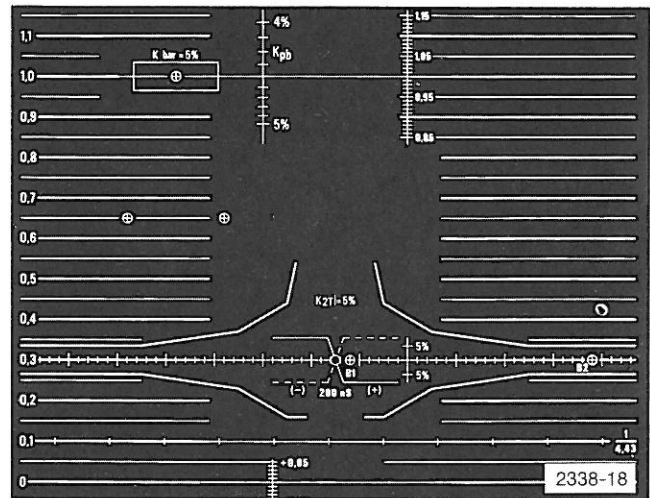

Fig. 2-4. CCIR Composite, K-Factor combination graticule supplied with 1480-Series 625/50 instruments.

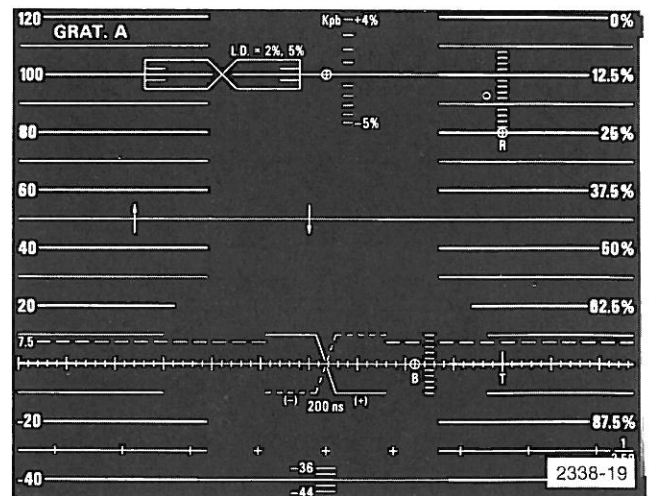

Fig. 2-5. NTSC Composite Graticule A supplied with 1480 and 1485.

Photo graticules are reduced in scale to eliminate parallax errors. The CCIR Composite/K-Factor graticule, the NTSC Composite Graticule A, and a special Short Time Distortion measurement graticule for NTSC (Graticule B) are all available in both visual and photo scales.

The special Short-Time Distortion graticule for NTSC (Graticule B) are all available in both visual and photo scales.

The special Short-Time Distortion graticule for NTSC, Graticule B, is supplied with 1480 and 1485 only. Graticule B is shown in Fig. 2-6. Graticule B's two masks, 2% and 5%, are in accordance with IEEE Trial Standard 511-1974. Information on the use of all three major measurement graticules can be found in Tektronix Television Products Application Notes 12 and 20, contained in Section 3 of this manual.

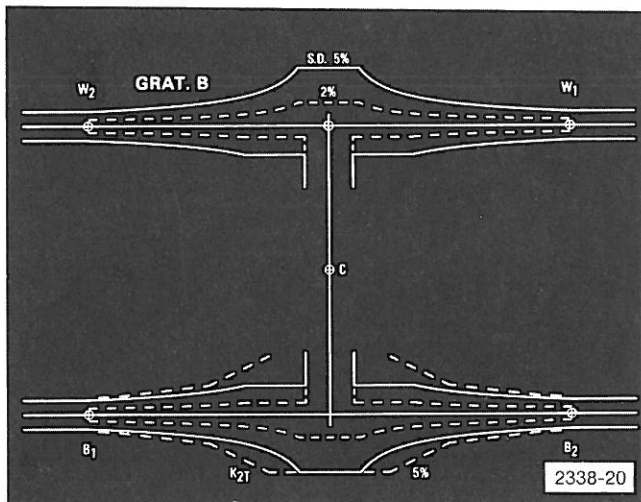

Fig. 2-6. NTSC Short-Time Distortion measuring graticule, Graticule B.

An NTSC non-composite pattern is available as an optional, extra-cost, external graticule. Refer to the TV Products Catalog or call your local Tektronix representative.

Graticule horizontal scales are divided into 12.7 divisions along the horizontal line at blanking level. The vertical graduations are scaled according to measuring units and ranges peculiar to each system—mV for the CCIR graticule, and IRE units and percent modulation for NTSC. The graticules are also marked for K-factor tolerances and linear-distortion measurements.

Internal

With the SCALE ILLUM control pushed in, the internal graticule is edge-lighted. The range of illumination is sufficient for comfortable viewing in a studio environment or for taking waveform pictures with Tektronix Oscilloscope Camera Systems. The internal graticule offers parallax-free viewing that greatly enhances measurement of distortions, amplitudes, and level-setting adjustments.

External

External graticules can be installed quickly and easily. Simply unscrew the crt bezel cap nuts, remove the crt bezel and fit the graticule over the faceplate with the printed side in. Depending on the TV system for which the graticule is designed, the Back Porch Cal Ampl switch (see Fig. 2-7) must be positioned to the left (NTSC) or right (PAL) position to match the locating hole at the lower edge of the external graticule. Thus, when the PULL FOR EXT SCALE ILLUM control is activated to turn on the external-graticule lights, the calibrator signal amplitude will be automatically selected when the DC RESTORER is in BACK PORCH. SYNC TIP position always produces a 1-volt signal.

CAUTION

Failure to place the switch in the proper position will cause its destruction and an erratic or nonexistent calibration signal.

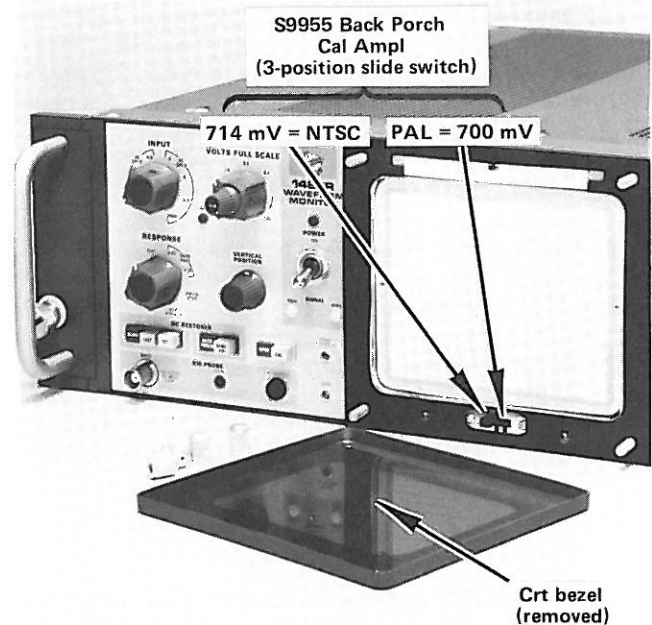

Fig. 2-7. Location of the Back Porch Cal Ampl switch, S9955. Same location for both rackmount and cabinet model.

OPERATING PRECAUTIONS

When operating the 1480-Series Waveform Monitors, front-panel controls can be set in a manner that exhibits anomalous displays. The following discussion identifies those operating modes that should be avoided.

1. In the ALL FIELDS mode center two buttons pressed), with DISPLAY in $5 \mu\text{s}/\text{DIV}$ or $10 \mu\text{s}/\text{DIV}$, and the LINE SELECTOR VAR pressed, no display will be obtained if the LINE SELECTOR VAR potentiometer is set to display lines during the time a second field would have been displayed.

The ALL FIELDS mode time-overlays each successive field on the first half of the 2 FIELD display, thus the maximum ramp amplitude at the 2 Field Sweep Generator is 5 volts. The LINE SELECTOR VAR control has a range of 0 to 10 volts at the input to the 2 Field Sweep Generator. Since the LINE SELECTOR VAR control voltage is applied to one side of a comparator in the 2 Field Sweep Generator device, there is no delayed gate output if the LINE SELECTOR VAR is set above the maximum ramp voltage (5 volts).

2. The four front-panel FIELD buttons would seem to imply that the 1480-Series monitors identify four fields of any television system. In PAL systems, the Bruch sequence certainly identifies four fields, but NTSC and PAL without Bruch sequence systems have four less-clearly identified fields. These fields are determined by subcarrier phase with respect to the leading edge of line sync. The 1480-Series monitors positively identify four PAL fields in the presence of the Bruch sequence, but cannot identify fields that are different from each other only in the phase of the subcarrier with respect to line sync.

3. If composite PAL video is applied to the AUX VIDEO IN connector and composite sync to the EXT SYNC IN connectors, with no signal to the VIDEO INPUTS or with the INPUT switch in the PROBE position and SYNC in EXT, the 1480-Series monitors will not positively identify the four PAL fields even in the presence of the Bruch sequence. All the sync functions appear normal, but the Frame Pulse Generator does not receive burst information.

4. Do not attempt to use the AUX VIDEO IN as an end-of-line termination for a signal looped through other instruments if the 1480-Series POWER switch is off. With POWER on, the AUX VIDEO IN circuit is internally terminated in 75Ω , but with POWER off, the impedance is around 80Ω .

5. The additive calibrator mode (where the front-panel CAL and OPER buttons are pressed simultaneously) operates only with the video signal connected to the A VIDEO INPUT. If the INPUT switch is in B or PROBE, the display in the additive calibrator mode will still be whatever is connected to the A VIDEO INPUT superimposed on the calibrator signal.

6. With the INPUT switch in the PROBE position and the front-panel CAL button pressed, the DC Restorer is disabled and no clamping is done. The DC Restorer operates with the OPER button pressed.

7. The calibrator timing flipflop is disabled if the LINE SELECTOR 15 LINES button is pressed and the DISPLAY switch is in $5 \mu\text{s}/\text{DIV}$, 2 FIELD, or EXT.

8. In PAL instruments, the lack of Bruch sequence in the incoming video signal causes loss of sweep if FIELD 1 or FIELD 4 buttons are pressed individually ($12 \frac{1}{2}$ Hz sweep rate).

9. In Option 4 and Option 5 (VTR T.W. Sync Input) instruments the DISPLAY switch in $10 \mu\text{s}/\text{DIV}$ and 2 Field sweep enabled through J9034, using the MAG switch causes the display to shift about one field to the left.

10. To prevent damage to the crt, the unblanking for the External Horizontal display mode is disabled. An internal wiring change is required to activate the unblanking.

MEASUREMENT TECHNIQUES

Using WAVEFORM COMPARISON

The most obvious use of the WAVEFORM COMPARISON function is to check amplitude ratios such as pulse-to-bar measurement. This measurement mode can be used on any line or pair of lines that can be displayed, including lines selected in the LINE SELECTOR modes.

WAVEFORM COMPARISON is also useful in comparing amplitudes of the modulated packets on the linearity staircase signal. Differential gain can be checked with the modulated staircase applied and the waveform monitor in the BANDPASS RESPONSE position and 0.2 VOLTS FULL SCALE. By overlaying the last modulation packet on the first, any differences can be easily viewed and measured.

Adjacent lines can be overlaid and amplitudes compared, using the $10 \mu\text{s}/\text{DIV}$ DISPLAY position. Locate the break-point at the line sync pulse in the center of the display and adjust OVERLAY control as necessary to overlay the two lines.

Using the Calibrator

The calibrator signal can be set to one of three values, as determined by front-panel switches. With the CAL and SYNC TIP DC RESTORER buttons pressed, the squarewave amplitude is one volt. No other value is possible, or needed, since all television standards employ a one-volt into 75 Ω composite video signal. Adjustment of the front-panel GAIN control in this mode is simply a matter of adjusting until the calibrator display coincides with the appropriate internal graticule markings. Measuring the distance from blanking to peak white is not so straight forward, since different television standards employ different amplitudes. Dual-standard models of the 1480-Series use a precise resistor divider with taps for different values. Which tap is used is determined by the setting of the Back Porch Cal Ampl switch and the position of the SCALE ILLUM switch. The Back Porch Cal Ampl switch is located inside the crt bezel below the crt.

When external graticule lighting is desired, pull the SCALE ILLUM control out. This also enables the Back Porch Cal Ampl switch to control signal amplitude. The setting of the Back Porch Cal Ampl switch is determined by a hole in the external graticule into which the switch thumb slide fits. NTSC graticules set the slide switch to the 714 mV tap on the resistor divider. CCIR graticules set the slide switch to the 700 mV position. See Fig. 2-1 and CAUTION note under External (page 2-9).

The calibrator signal is particularly useful in the additive calibrator mode. In this mode, both OPER and CAL are pressed, superimposing the A VIDEO INPUT signal on the calibrator waveform. Signal amplitude errors are easily distinguished by noting differences between the bottom of the upper display and top of the lower display.

Using the DC RESTORER

The DC RESTORER clamps either the back porch or the sync tip of the composite-video waveform to 0 V. The two rates of restoration (FAST and SLOW) allow the user to compare the signal in the presence of hum to the signal with hum attenuated. The FAST mode attenuates mains hum by at least 26 dB, while the SLOW mode attenuates by 0.9 dB or less.

In addition, an internal jumper can be changed to increase the fast clamp (restorer) speed. This jumper (P1993) should only be changed by a qualified technician because this change requires the removal of the protective covers. Instructions for this and other program changes appear in Section 6 of the SERVICE part of this manual.

In the fast slew rate, rapid restoration is accomplished but the circuit is more susceptible to noise. In the slower of the fast slew rates (the one normally programmed at the factory) the dc restorer is less susceptible to noise but is takes longer to clamp.

Clamping at the back porch is automatically selected internally when RESPONSE is in LOW PASS. Rise and fall of sync pulses in LOW PASS are so low that there is no sync tip left to clamp.

The DC RESTORER is inhibited in DIFF'D STEPS because the recovery of the differentiated sync pulse is not complete by either sync tip of back porch time.

The BANDPASS filters do not pass any dc or low-frequency signal components, so while the DC RESTORER still operates, it does not affect the display.

Using the AUX VIDEO IN and AUX VIDEO OUT

The AUX VIDEO OUT jack on the rear panel provides an unfiltered output, internally-terminated in 75 Ω . The AUX VIDEO IN is a 75 Ω internally-terminated input that provides input access to the vertical system following the filters.

These two access points can form an external loop around the filters, and measurements or corrections can be made in this loop, for example, (using a chrominance-to-luminance delay corrector) without disturbing the input signal. An advantage of this function is the ability to compare a uncorrected signal with the corrected signal by switching between the AUX VIDEO IN and FLAT position of the RESPONSE switch.

The AUX VIDEO OUT is also one end of an impedance-converting network. The other end is the X10 PROBE input, available as an option. The signal acquired with the probe is processed in the same circuits as a video input. The AUX VIDEO OUT is internally terminated in 75 Ω , making it compatible with the rest of the video system. The signal acquired with the probe can then be routed through AUX VIDEO OUT to a display of measurement device such as a vectorscope.

Using a X1 probe for signal acquisition permits ten-times signal gain and is useful for low signals such as hum or residual subcarrier.

Using the RGB/YRGB Input (J9034)

J9034 provides control and signal access for stepping the Waveform Monitor Sweep with the RGB or YRGB staircase. The encoded line-rate or field-rate camera pick-up tube "parade" signal can then be applied to one of the VIDEO INPUTS and the various pick-up tube matching adjustments can be easily made.

J9034 pin D is the access for sweep length alteration. Grounding this point shortens the sweep, allowing the RGB/YRGB staircase to step the "parade" across the crt so that the outputs of the camera pick-up tubes are seen on the same display.

The RGB/YRGB staircase is applied to J9034 pin C. The staircase repositions the shortened sweep. (The sweep is not shortened in time, only in distance traveled across the crt.)

A mating, male plug (P9034) is available for applying external RGB/YRGB input signals to J9034. See Accessories in the rear of this manual for ordering information.

It is possible to alter the length of the sweep by changing the value of two resistors. Since this is a circuit change, it should be attempted only by a qualified technician. Information on these values changes can be found in Section 6 of the SERVICE part of this manual.

1480-Series instruments are shipped with plug-jumpers P4032 and P4240 installed. With these plugs in place, the gain is set for RGB operation; for YRGB operation they need to be removed. Because these changes require removing protective covers, they should only be done by a qualified technician, using the instructions from Section 6 of this manual.

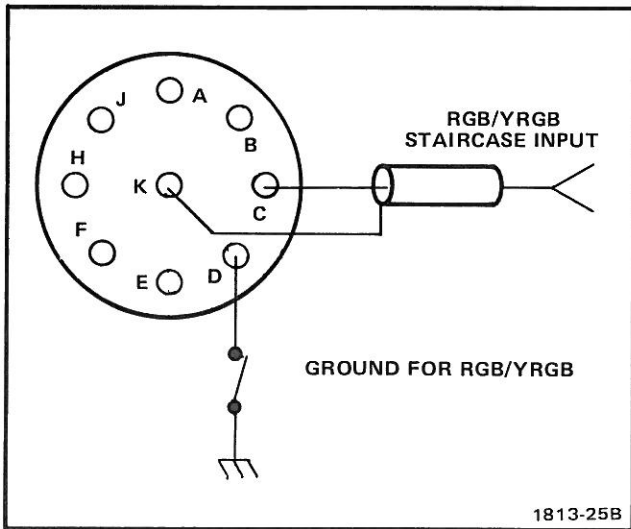

Fig. 2-8. J9034 connections for RGB or YRGB operation.

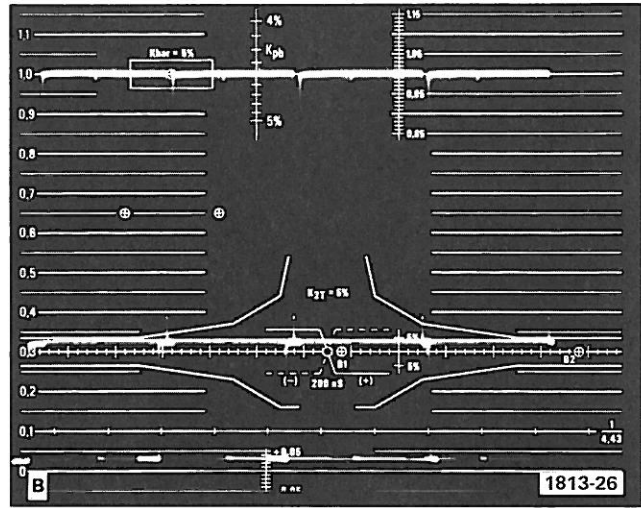
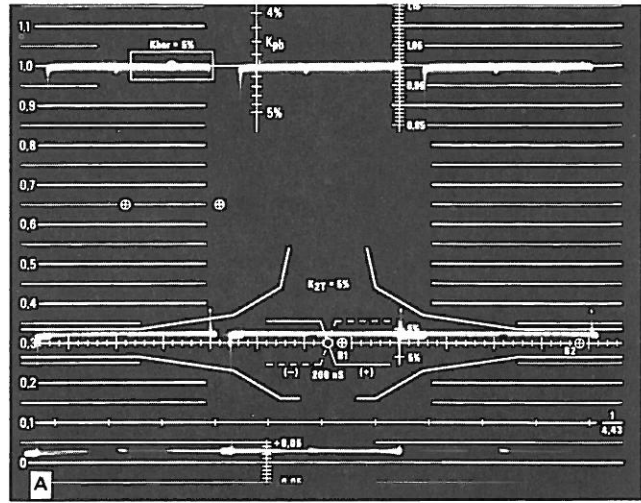

Fig. 2-9. (A) three step RGB display. (B) YRGB display, note 4 steps.

Using PIX MONITOR OUT

The amplifier that drives AUX VIDEO OUT also drives PIX MONITOR OUT. The only difference between the two outputs is that PIX MONITOR OUT contains the line strobe when the waveform monitor is in one of the LINE SELECTOR modes.

This output, when connected to a picture monitor, enables the user to view the waveform monitor display as a television picture and at the same time to see the exact location of the line or lines (15 LINE) selected by the LINE SELECTOR controls.

Some picture monitors do not react favorably when the inserted line strobe crosses the field sync area. External synchronization of the picture monitor should eliminate the unfavorable reaction.

Using LINE STROBE OUT

The LINE STROBE OUT is an ac-coupled, positive-going, TTL-compatible output, time-coincident with the line or lines selected by the LINE SELECTOR controls. This signal can be used to brighten a picture monitor display, or can be superimposed on an oscilloscope display for identification of selected lines. The LINE STROBE OUT can also be used as a form of delayed gate to trigger some other unit at the selected line.

Using DIRECT and AFC SYNC

DIRECT SYNC uses a wide-band trigger circuit that accepts and processes low-frequency signals as well as line-rate sync. AFC SYNC uses a narrow-band trigger circuit that is limited to $15.75 \text{ kHz} \pm 200 \text{ Hz}$, but at the same time is relatively immune to noise.

Noise-caused jitter can be reduced by using the AFC mode, enabling the user to view a more stable waveform display.

Using EXT SYNC

The EXT SYNC function is useful when viewing a non-composite video signal, such as might be acquired through the optional X10 PROBE input. The sync signal used must lock both the waveform monitor and the unit under test.

A stable display can be obtained in the presence of small-amplitude signals, assuming the availability of at least 200 mV of composite sync to lock both the waveform monitor and the signal source.

Using EXTERNAL HORIZ IN

The EXTERNAL HORIZ IN is provided for signal input access in case some special sweep rate is required. A five-volt ramp will generate a 12.7 division trace. Input impedance of this circuit is about 10 k Ω .

Unblanking for External Horizontal operating mode is shipped from the factory in a disabled condition. An internal wiring change is required to activate this unblanking. See note on diagram 9.

OPTIONS

The following portion of the Operating Instructions deals with customer-ordered options. If none of the options listed here are in the 1480-Series Waveform Monitor used with this manual, disregard this part of the Operating Instructions.

OPTION 1 (X10 Probe)

Operating Instructions

The signal from the X10 PROBE INPUT is inserted in the vertical system at the same point as signals applied to the A and B VIDEO INPUTS. All front-panel controls then have the same effect on the X10 Probe signal as they have on other signals.

Pressing the front-panel CAL button provides a squarewave output at the CAL OUTPUT jack, to be used for probe compensation.

Connect a 10X Probe from the X10 PROBE INPUT to a source of 1-volt peak-to-peak composite video. Set the VOLTS FULL SCALE to 1.0, RESPONSE to FLAT, INPUT to PROBE, DISPLAY to 10 μ s/DIV, and MAG to OFF. Press the DC RESTORER SLOW and BACK PORCH, OPER, EVEN FIELD, SYNC INT and AFC, LINE SELECTOR off buttons. This will cause a 1-volt display.

Set the front-panel controls to each position in turn and note that the effect is the same for the X10 PROBE signal as for normal operation.

OPTION 2 (Carrying Case For Cabinet Models)

This option has no effect on the operation of the 1480-Series Waveform Monitor.

OPTION 3 (Blank CRT)

This option is ordered for use with special graticules. Operating instructions, out of necessity, will be generated by the user.

OPTION 4 and OPTION 5 (VTR Tone Wheel Sync)

Operating Instructions

With the 1480-Series Option 4 Waveform Monitor installed in an RCA TR70C, operation is virtually automatic. The TR70C provides external locking signals, switching commands, and input signals so that the Waveform Monitor displays the signal of interest.

The signal of interest is selected by pressing one of the Waveform Monitor Selector pushbuttons, located on the TR70C panel below the Waveform Monitor. For detailed instructions about using the Waveform Monitor in the TR70C, see RCA Operation and Installation Manual, 1B-32168. Some typical displays are shown in Fig. 2-10, 2-11 and 2-12.

OPTION 6 (124 Ω Balanced Inputs)

Option 6 is a large-scale modification of the 1480-Series Waveform Monitor and for that reason employs its own Instruction Manual Supplement (Tektronix part number 070-2064-00) which contains complete operating instructions.

OPTION 7 (Slow Sweep)

Slow Sweep uses triggering either from internal or external source. Display mode is selected by the setting of the DISPLAY switch. It can be set to +TRIG PLRT (triggering polarity), which starts the triggered sweep on the transition from black or near black to white or near white, or -TRIG PLRT which is the opposite transition.

Sweep duration is controlled by a variable, labeled VAR, which provides a change in sweep speed of about 3 to 1.

50/60 Hertz Triggering uses the rear-panel AUX SYNC INPUT connectors. Triggering mode is selected by simultaneously depressing both INT and EXT SYNC pushbuttons.

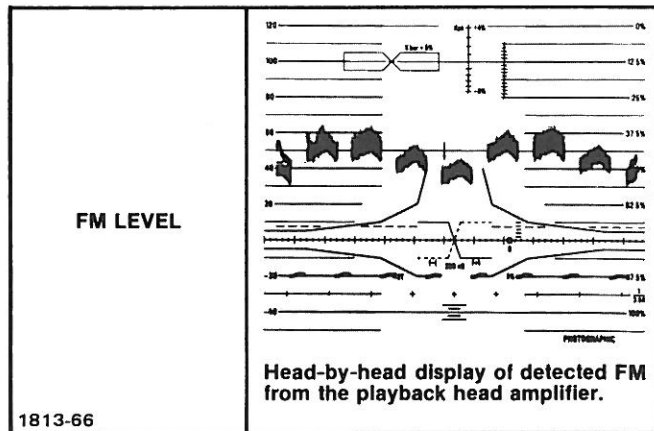
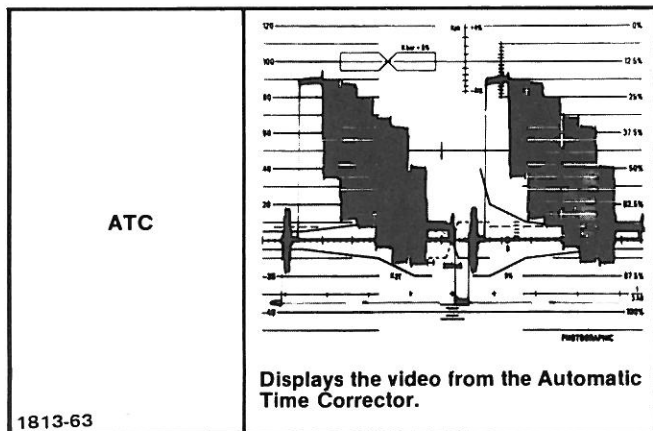
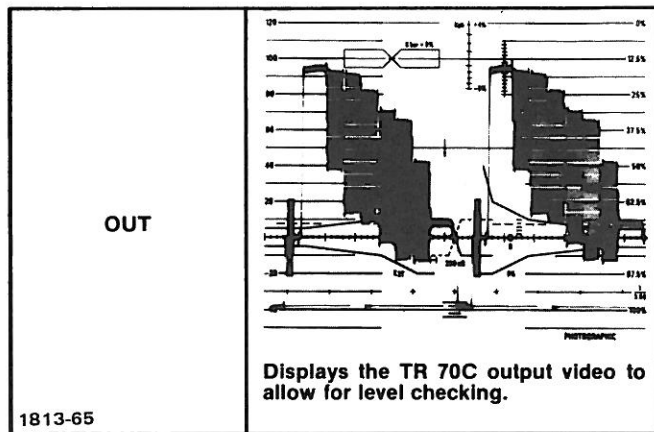
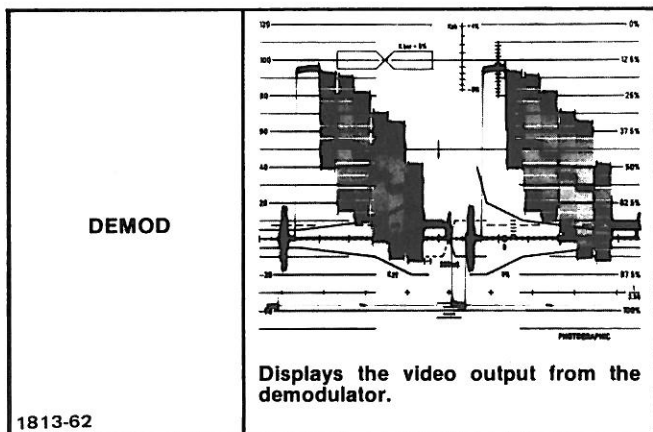
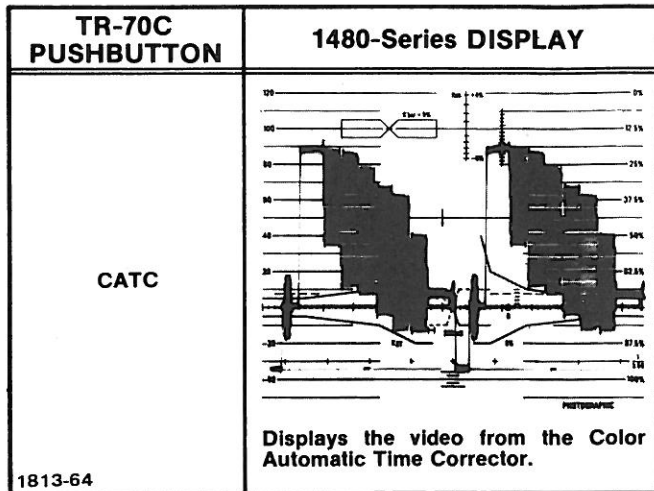
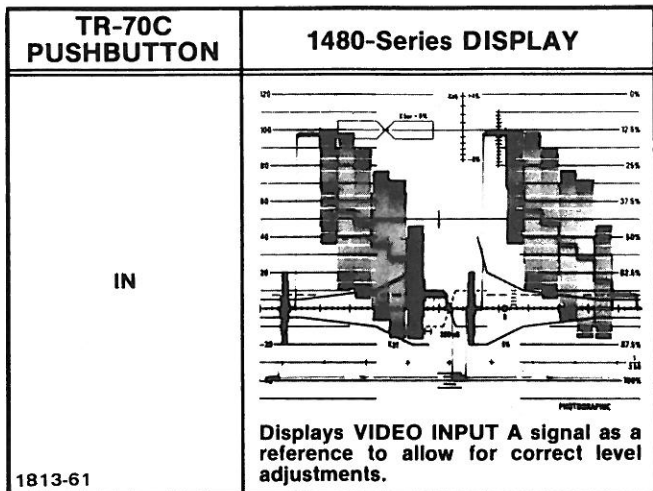

Fig. 2-10. Operating waveforms from RCA Video Tape Recorder model TR70C.

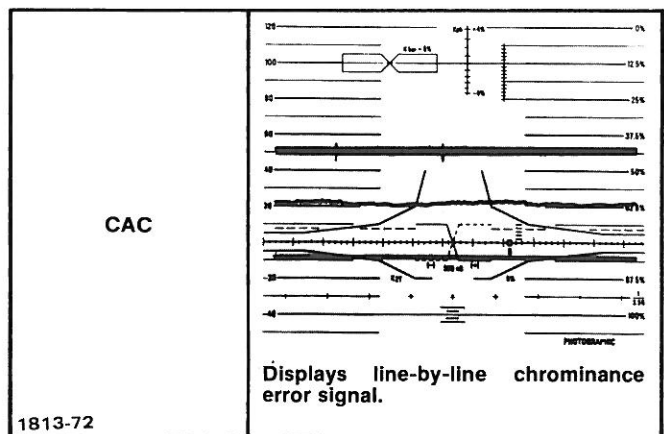
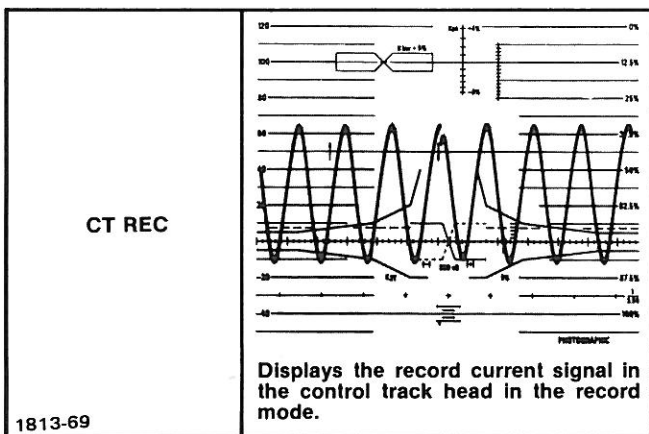
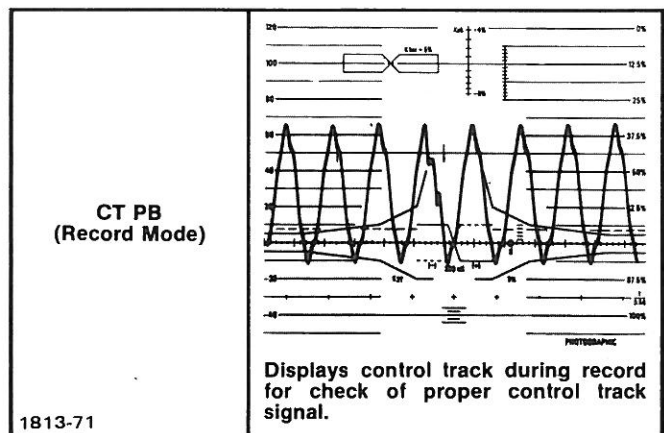
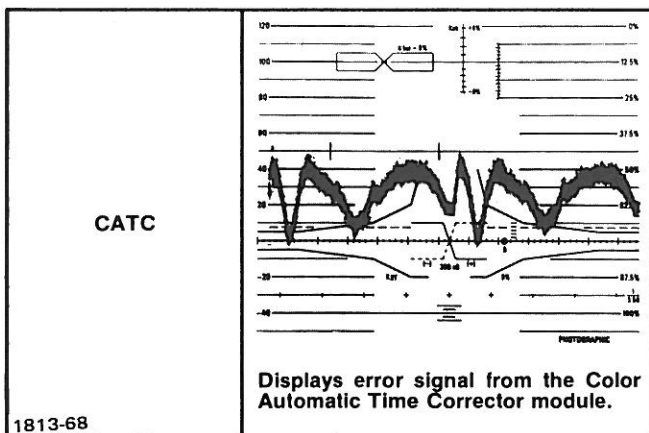
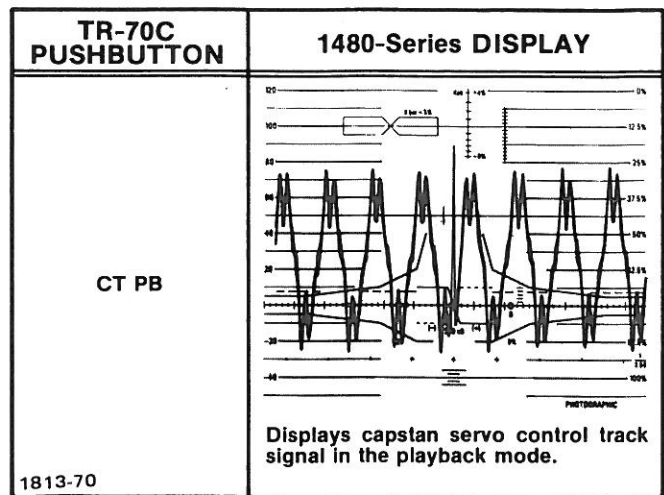
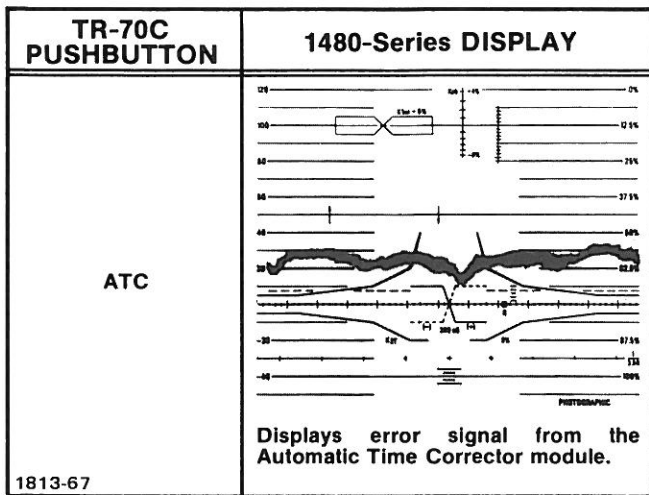

Fig. 2-11. TR70C operating waveforms (cont).

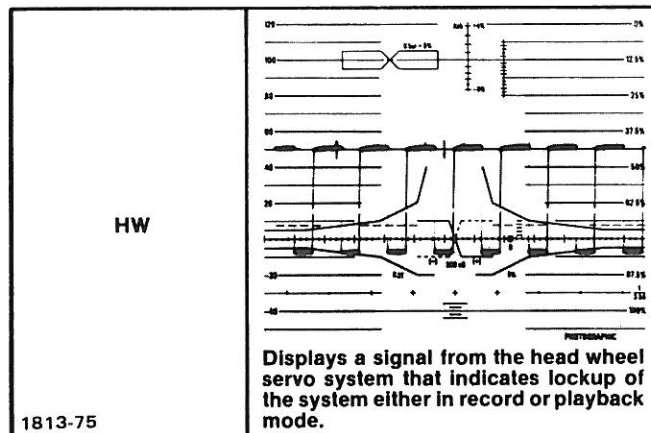
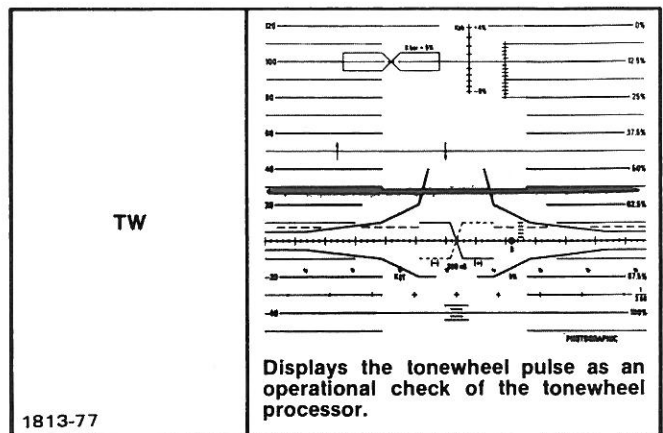
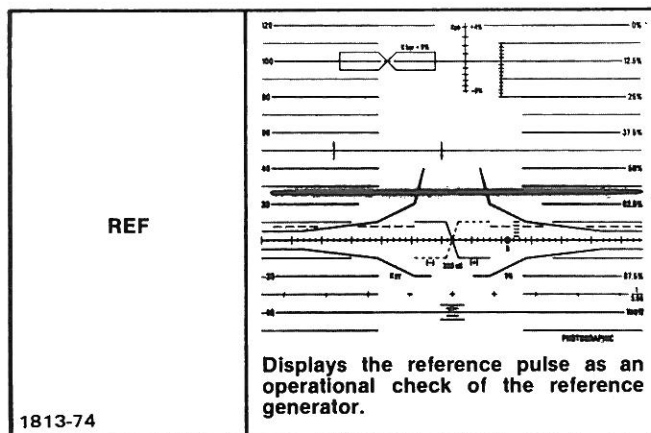
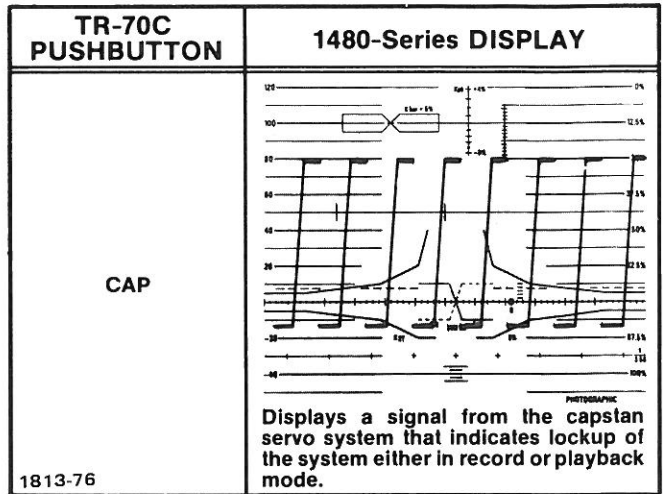
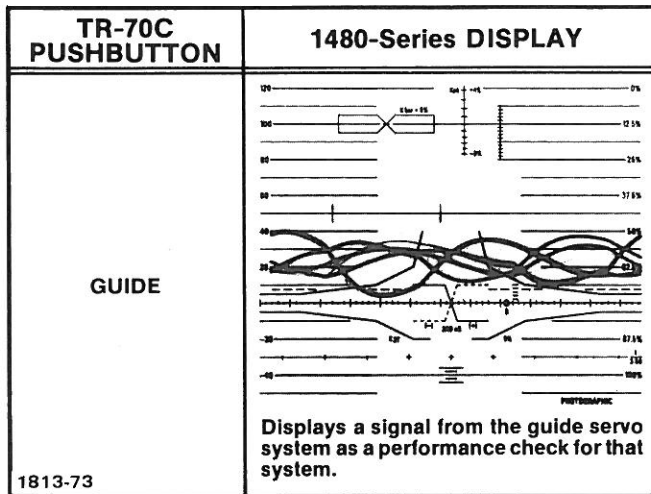

Fig. 2-12. TR70C operating waveforms (cont).

APPLICATION NOTES

Information contained in this section is of a specific nature and goes far beyond normal Operating Instructions. In some cases the information is new and has been added to this manual to keep it current. Whenever new information, concerning the operation of this instrument, becomes available in application note form, it will be distributed through mailings and later be bound into reprints. In order to keep this manual current, periodically check with a Tektronix Television Specialist or sales

representative about any new Application Notes pertinent to this instrument.

Some of the Application Notes in this section were authored by renowned authorities in the field of video measurement. Their topics include some new and highly accurate measurement techniques that are destined to become standards of the television industry.

Table of Contents

Application Note	Title
11	Measurement of Signal Level with the 1480-Series of Waveform Monitors
12	Operational 625-Line Measurements with the 1480-Series of Waveform Monitors
13	Time Base Fold Back, A Novel Improvement Over Double Triggering for Video Testing
14	Superimposing Alternate Field ITS to Improve In-Service Testing
15	Enhanced Video Measurement Capability Using the 15-Line Display of the TEKTRONIX 1480-Series Waveform Monitors
16	Verifying the Bruch Blanking Sequence
17	The Auxiliary Video of the 1480-Series of Waveform Monitors
20	A New NTSC Graticule For the 1480 Waveform Monitor
21	All Fields Display to Improve NTSC In-Service Testing



TEKTRONIX®

*committed to
technical excellence*

application notes

no. 11

The Measurement of Signal Level with the 1480-Series of Waveform Monitors

by L.E. Weaver
Tektronix European TV Engineering Consultant

The amplitude of the video signal needs to be set to its correct value within a very small tolerance range at all points in the TV signal chain where such waveforms are found.

This requirement has been fully taken into account in the design of the 1480-Series of Waveform Monitors, which provide the user not only with the conventional square wave calibrating signal, but also with level measuring facilities of a kind not previously found in commercial instruments.

The method employed is not, in fact, novel, since it was first described more than 10 years ago¹, and it has for a long time been in standard operational use by a TV broadcasting organisation internationally known for its high standards, but its merits as an operational procedure do not seem to have been more widely recognised until now.

How it Operates

The basic principle is remarkably simple, although it is very easy to make it appear quite complicated. For the sake of clarity, therefore, suppose it is required to set the overall amplitude of the video signal by means of an ITS signal, say the internationally-agreed line 17. By definition, this amplitude is the voltage difference between the mid-point of the top of the luminance bar and the mid-point of sync bottom.

Now set up the waveform monitor as follows:

INPUT	A (looped-through or correctly terminated at input)
VOLTS FULL SCALE	1.0, CAL
RESPONSE	FLAT
DC RESTORER	FAST, SYNC TIP, OPER and CAL buttons both depressed
MAG	OFF
DISPLAY	5 μ S/div
FIELD	1, 3
LINE SELECTOR	17, DIG
SYNC	INT, DIRECT
ALL FIELDS	OFF

The display obtained with these settings will probably seem confusing just at first glance, so to make it clearer to understand reduce the input temporarily to about 50% of the previous value, when it will be evident that the display consists of the same ITS waveform, repeated at two levels (Figure 1).

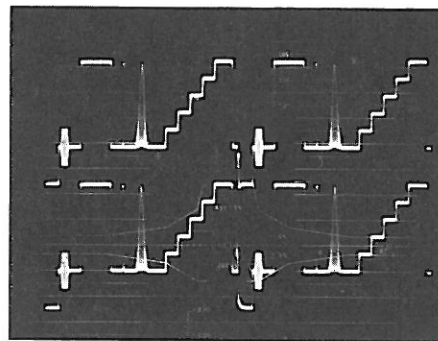

Figure 1. Normal display at reduced amplitude

What, in fact, has happened is that a square wave whose period is 4H, i.e. 4 times line duration, and whose amplitude is exactly one volt, has been linearly added to the test waveform. A complete cycle of the square wave looks like the photograph (Figure 2) with a pair of TV lines successively located at each of the two voltage levels, but the synchronizing arrangements of the 1480-Series are such that the display always appears in the overlaid form.

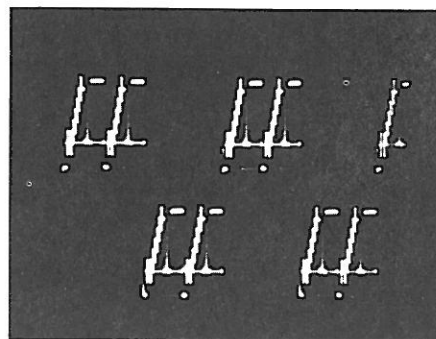

Figure 2. Display locked to calibrating square wave.

Since the vertical separation of the two traces is as has been said, exactly one volt, it follows that when the sync bottom of the upper trace is located on precisely the same horizontal graticule line as the bar top of the lower trace, then the overall amplitude of the video signal is also one volt. This provides a very simple criterion for determining when the correct level has been achieved, which is free from parallax error and at the same time independent of changes in average picture level because of the operation of the D.C. restorer.

Setting the Overall Level

The basic practical procedure is therefore as follows. Check that the correct waveform is being displayed; this should appear at two levels, as has been explained above. Select a convenient horizontal graticule line as a reference, and position the display so that the sync bottom of the upper waveform and the bar top of the lower waveform are roughly equidistant about this line. Then as the level is varied it will be found very simple to bring the sync bottom and the bar top into the same horizontal line, using the reference line as a guide. This is the correct setting for the video level.

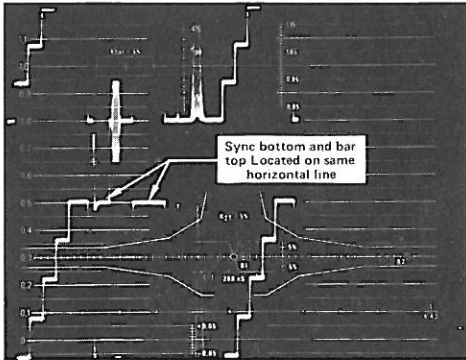

Figure 3a. Correct setting with gain normal.

Improving the Resolution

When the signal amplitude is increased from, say 1.0 to 1.1 V, the separation between the bar top and the bottom of sync also increases by the same amount, which appears as one full graticule division on the display. Hence a voltage ratio of 1.1:1, i.e. 0.8dB, is equivalent to a division. If it can be assumed that the signal is not unduly noisy, which will certainly be the case in studio areas, one can estimate the resolution of the measurement to be about one tenth of a division, say 0.1 dB.

This is good enough for some purposes. However, with the 1480-series the gain may be increased by up to five times without distortion, so that the resolution can be improved to a figure of about 0.02 dB, which offers the possibility of very accurate measurements (Figure 4).

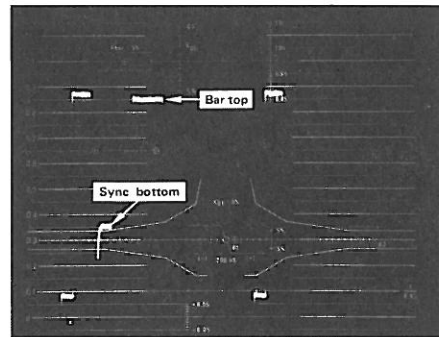

Figure 4. Level 10% high, X 5 gain.

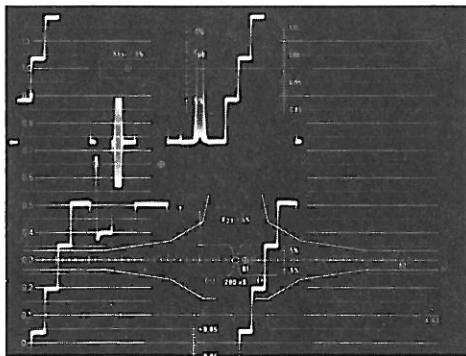

Figure 3b. Level 10% high.

The resolution obtained in practice is, of course, limited by the random noise level present in the signal under test. That is in no way special to the present method, but is perfectly general. Where the signal is noisy, a useful improvement is possible by first passing it through a low pass filter, which reduces the bandwidth without unduly deforming the flat portions of the bar and the sync pulse, although the accuracy will then depend upon a correct allowance being made for the insertion loss of the filter. The amount of improvement obtained is a function of the character of the random noise.

With the 1480-Series a useful device is to alter the RESPONSE control from FLAT to IRE, which attenuates the higher video frequencies with very little distortion but does not affect the calibration of the instrument. In more severe cases, the use of the LOW PASS setting is permissible. The marked improvement which can be obtained in this simple way is very clearly shown in Figures 5a, 5b, and 5c.

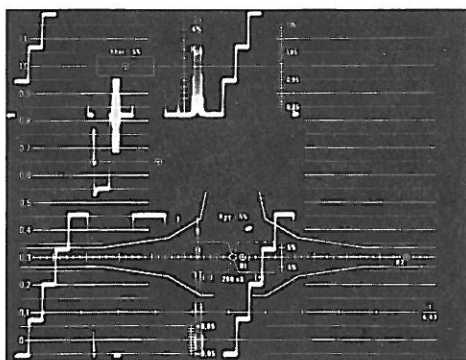

Figure 3c. Level 10% low.

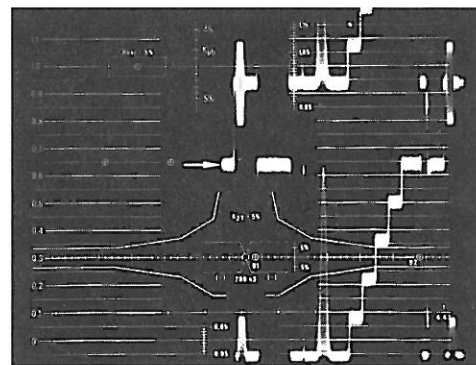

Figure 5a. Signal with random noise, FLAT response.

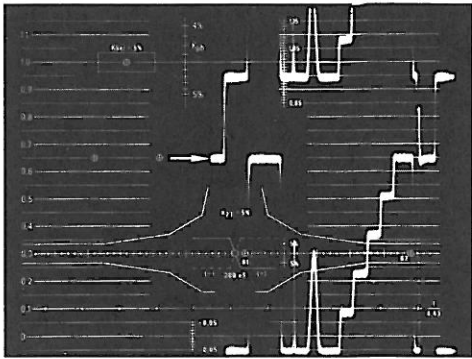

Figure 5b. As Figure 5a but IRE response.

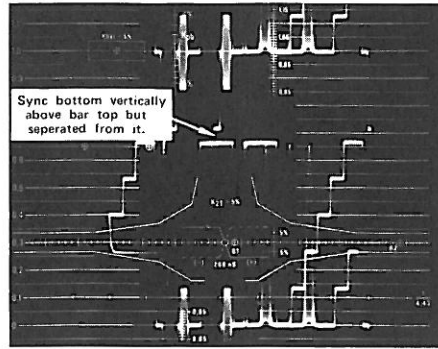

Figure 6b. As Figure 6a but level 5% low.

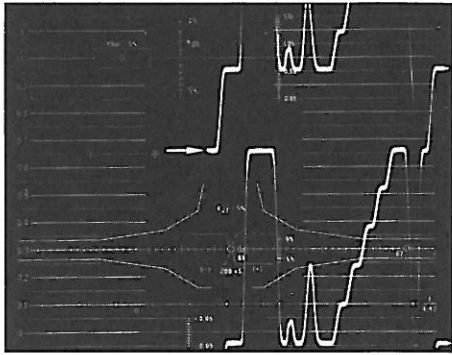

Figure 5c. As Figure 5a but LOWPASS response.

Measurement of Picture Component

So far, the setting of video level has been described entirely in terms of the overall one volt amplitude of the signal. However, it is often required to check the amplitude of the picture component in addition. This is quite simply brought about by changing the DC RESTORER button from SYNC TIP to BACK PORCH. This not only alters the clamping mode, but at the same time brings in a square wave whose amplitude is 700 mV for 625-line signals or 714 mV for 525-line signals. With dual-standard instruments the changeover is effected automatically when either the internal or the external graticule is brought into use by actuating the SCALE ILLUM control.

The procedure is exactly the same in principle as that used for the overall amplitude, and the same remarks apply, with the exception that the use of the overlay facility is less advantageous, as can be seen from the photographs Figures 7a, 7b.

Use of Overlay

Yet a further improvement can be effected by the use of the overlay facility of the 1480-Series, which makes it possible to bring the bar top and the sync pulse bottom into the same vertical axis, with the result that the correct adjustment of level is achieved with the two reference points actually overlaid. Apart from the added convenience of use, this provides a small but significant improvement in resolution, since it is easier to adjust for minimum thickness of line than it is to ensure that the two reference points lie on the same horizontal graticule line. The appearance of the display with both a correct and an incorrect adjustment is shown in Figures 6a and 6b.

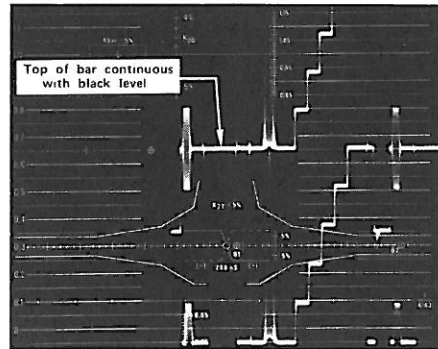

Figure 7a. Measurement of picture component, level correct.

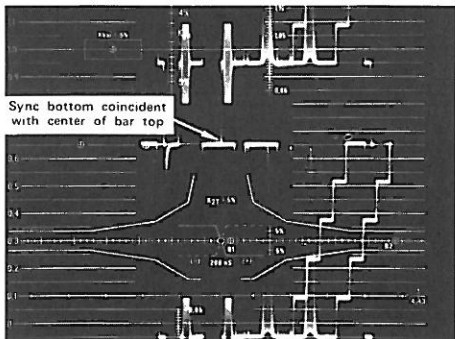

Figure 6a. Use of OVERLAY, level correct.

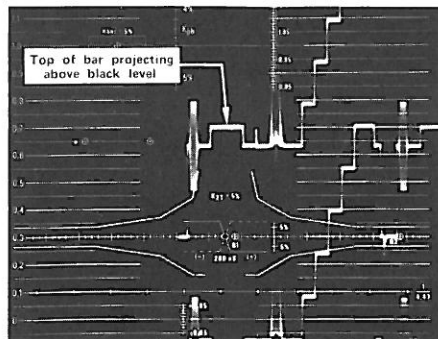

Figure 7b. As Figure 7a but level 10% high.

The sync pulse amplitude is not measurable directly by this method, but of course it is available by subtracting the picture amplitude from the overall.

Comments

This method of setting and measuring the level of video signals has the great advantages of absence both of parallax and of the transfer error associated with the conventional method.

To understand what this latter means, consider how such a measurement is most usually carried out. A calibrating square wave is first displayed, and the vertical gain is adjusted until it appears to fit as well as possible between two fixed graticule lines. The square wave is then removed, and the video waveform displayed and compared against the same pair of reference lines.

Several sources of error enter into this process. There will be some uncertainty in fitting the calibrating waveform against the reference lines, and a similar uncertainty when the video waveform is compared with them. In addition, the vertical gain will change by some finite amount between these two settings particularly when, as often happens in practice, they may be separated by relatively long periods of time. The sum of these is the transfer error which, of course, is very appreciably magnified when parallax is present.

None of these errors occurs in the method described above, whose accuracy is impaired only by the tolerance range in the square wave amplitude itself, and the inaccuracy of setting. To take an example, the square wave amplitude in the 1480-Series is defined within $\pm 0.2\%$, and it has been shown above that the comparison error is probably not more than about 0.2% under suitable conditions. The overall error is therefore likely to be only about $\pm 0.4\%$. When one takes into consideration the fact that the conventional method does not permit the use of amplification to reduce the setting inaccuracy, it is clear that the present method shows a very considerable advantage, which is increased still further when an external graticule is in use and parallax errors are present in addition. The principal drawback of the method is its dependence upon a reasonably distortion-free signal. While good signals can be relied upon in picture generation areas, it is possible to find long-term distortions on distribution networks, for example, which can seriously affect the accuracy. In these instances, a modification of the transfer method is to be preferred. A suitable technique is described in Part 6 of the Tektronix Application Note 12, "Operational 625-Line Measurements with the 1480-Series of Waveform Monitors."

1: Weaver, L. E., The accurate measurement of video levels, EBU Review, Part A, vol. 69, pp. 2-4 (1961).

application notes



TEKTRONIX®
committed to
technical excellence

no. 12

Operational 625-Line Measurements with the 1480-Series of Waveform Monitors

by L. E. Weaver
Tektronix European TV Engineering Consultant

The well-planned and in certain respects novel display facilities provided on the 1480-Series of waveform monitors have made it possible to produce a new 625-line graticule enabling a full range of video waveform measurements to be carried out with a minimum number of manipulations, consequently simplifying operational procedures. In view of the growing importance of in-service measurements, its design has been based upon the international insertion test signal on line 17, but it can also be used, for example, with the U.K. national insertion test signal on line 19.

A clear and uncluttered graticule which is extremely simple to use has been ensured by functional planning and by the omission of all superfluous information. For instance, the K-factor limits have been restricted as far as practicable to a single value of 5%, chosen because it may be regarded broadly as a dividing line between distortions which are subjectively acceptable and those which rapidly become increasingly intolerable. It is also just slightly greater than the limit specified for the overall distortion in a high-quality television chain including one main transmitter¹.

Nevertheless, this has not resulted in a loss of reading accuracy since the distortionless windowing facility of the 1480-Series means that the vertical gain control can be relied upon as a simple and convenient way of changing the basic tolerance value by a series of known factors, i.e. the one diagram serves for 5%, 2½%, and 1% limits at the turn of a knob. These should be sufficient for practical purposes.

As an illustration of the applications of this new graticule in conjunction with the 1480-Series of waveform monitors, a brief summary of a suggested measurement procedure is given below. It should be noted that, apart from the initial settings and the inevitable readjustments of positioning controls and gain, only a single control needs to be moved throughout the series of measurements.

Measurement Procedure

Part 1: K_{hor} and K_{ph}

Control Settings:	Line Selector	17 and DIG
	FIELD	1 and 3 together
	DC RESTORER	BACK PORCH FAST
	MAG	OFF
	DISPLAY	5 μ s/div
	RESPONSE	FLAT
	VOLTS FULL SCALE	1.0

Set the start of the trace against the left-hand edge of the

graticule, and by using the VOLTS FULL SCALE VAR control in conjunction with the horizontal and vertical positioning controls, set the waveform so that black level coincides with the 0.3 line, the centre of the bar top passes through the circle in the K_{hor} "box", and the bar transitions pass through the pair of circles below the "box".

The value of K_{hor} is then read as the largest of the deviations of the bar top from the central horizontal line, whether above or below, between the vertical lines forming the ends of the "box".

The value of K_{ph} can also be obtained from the position of the peak of the 2T pulse on the scale marked K_{ph} .

If K_{hor} is appreciably less than 5%, the reading accuracy can be improved by using the VOLTS FULL SCALE control as a multiplier, and resetting the vertical position so that the centre of the bar again passes through the circle. The two steps convert the "box" limits of 5% into 2½% and 1% respectively. The appearance of the display during this measurement is given by Figure 1. (This figure is satisfactory for use as a routine check, but it has been obtained from a 10 μ s bar instead of the 25 μ s bar specified for K-rating purposes. A common way out of this difficulty is to double the 10 μ s bar value to give a K_{hor} comparable with the figure which would be obtained with a 25 μ s bar.)

Note: If there is any serious tilt of black level on the video signal there is an ambiguity in the setting of black level against the 0.3 line. It can be shown that the minimum error is obtained when the trace coincides with this reference line at the point marked B_1 on the graticule².

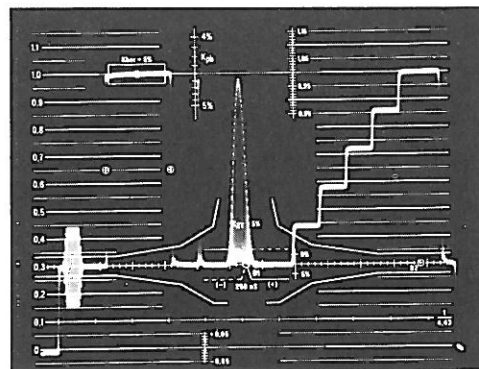

Figure 1. Measurement of K_{hor} and K_{ph} .

Part 2: K_{2T}

Control Settings:	MAG	x25 (200 ns/div)
	Others	As in Part 1

Turn the HORIZONTAL POSITION control until the 2T pulse is located symmetrically within the "submarine" tolerance diagram, with black level lying along the 0.3 line and the peak of

the pulse coinciding with the 1.0V line as in Figure 2a; the variable gain control will usually be required to achieve this. The symmetrical positioning of the pulse is best checked against the pair of uppermost lines.

K_{2T} is read as the greatest deviation of the baseline of the 2T pulse from flatness, using the tolerance limit lines as reference, e.g. if the distorted baseline just reached the limit lines at one or more points, then the value of K_{2T} would be 5%. Other values can be obtained by interpolation, or for appreciably smaller readings by increasing the vertical gain as described in Part 1 above, giving the type of display shown in Figure 2b.

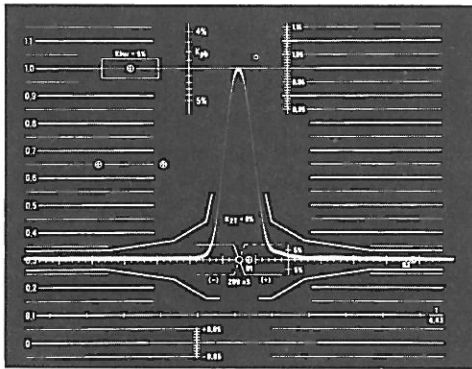

Figure 2a. Measurement of K_{2T} .

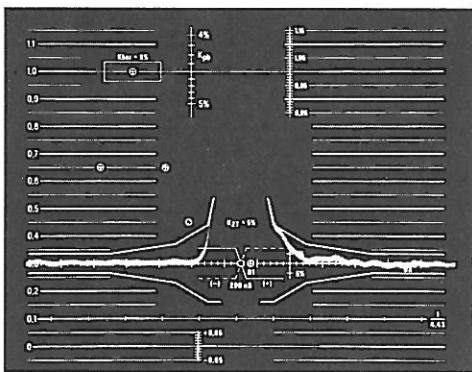

Figure 2b. As Figure 2a, but VOLTS FULL SCALE set at 0.2.

Part 3 (optional measurement): Bar Trail (Smear)

Control Settings: As immediately above.

In a linear system distortion at the lower video frequencies is measured by the value of K_{1q1} , but in some instances a type of non-linearity distortion may be present which gives rise to a slow decay of the trailing edge of the bar not consistent with the distortion of the bar top. A measure of the seriousness of this may be obtained immediately after the K_{2T} reading by shifting the trace horizontally until the mid-point of the trailing edge of the bar coincides with the right-hand member of the pair of circles beneath the K_{1q1} "box" (Figure 3). The percentage bar trail can then be found from the point where this transition intersects the small vertical scale located between points B_1 and B_2 .

Another form of this distortion may cause an undershoot followed by a slow rise to the final value. This is read off in exactly the same manner.

Note that this measurement does not form part of the standard K-rating method, but it has been found useful in the Federal Republic of Germany, and is at present under consideration by the CCIR3.

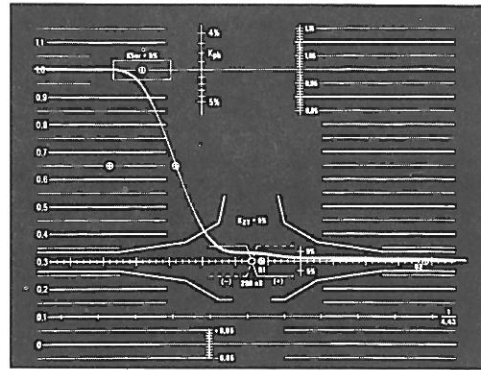

Figure 3. Measurement of bar trail.

Part 4: Chrominance-Luminance Gain and Delay Inequalities

Control Settings: MAG x5 (1 μ s/div)
Others As in Part 1.

There are two ways of carrying out this measurement. The first, by far the most convenient and accurate, utilizes a TEKTRONIX 1478 Calibrated Chrominance Level Corrector.

A. The 1478 may be inserted directly in series with the video signal under test. Alternatively, an arrangement which is much to be preferred when in-service measurements are to be carried out, the 1478 is connected in the AUX VIDEO path. It is then available simply by turning the RESPONSE control to AUX VIDEO IN, without the need for breaking the signal feed. However, since this path has a gain of 1.5 dB to allow for the loss of passive networks which may be used there, it will be necessary to introduce a compensating loss in front of the 1478. Preferably, this should take the form of a 75 Ω , 1.5 dB loss pad, but since all impedances are resistive, even a shunt or series resistor will suffice if facilities are limited. Values are given in the diagram.

The measurement then proceeds as follows.

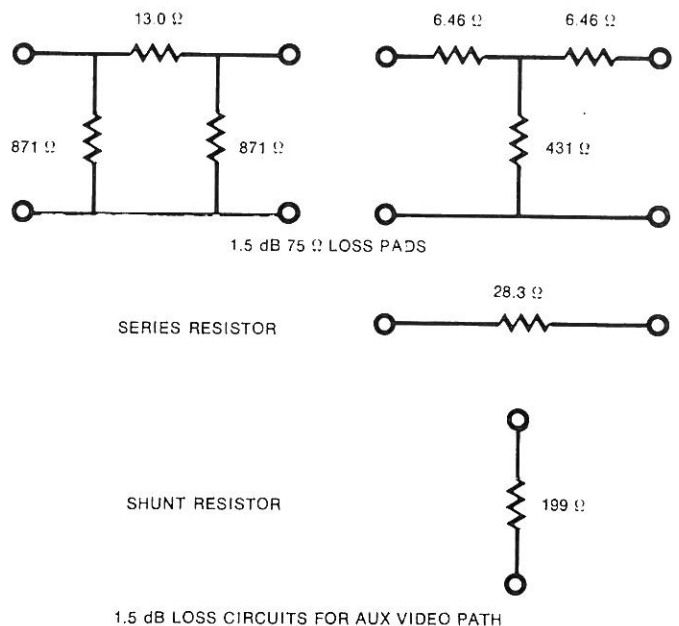

1.5 dB LOSS CIRCUITS FOR AUX VIDEO PATH

Application Notes—1480-Series (SN B060000-up)

Set black level along the 0.3 reference line and check that the midpoint of the bar top passes through the circle in the $K_{hd,1}$ "box". Then rotate the HORIZONTAL POSITION control until the baseline of the 20T chrominance pulse is located symmetrically within the "submarine" diagram (Figure 4a).

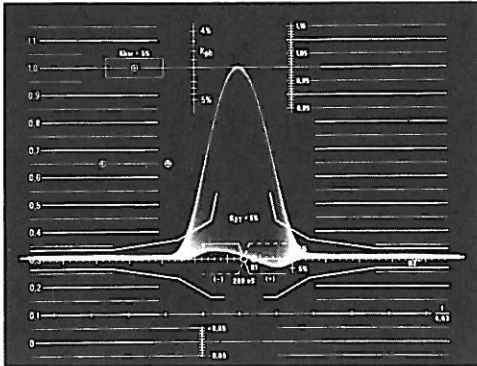

Figure 4a. Measurement of 20T pulse baseline.

Adjust the 1478 Corrector until the amplitudes of the upper and lower lobes formed by the pulse baseline intersecting with the 0.3 reference line are equal. The chrominance-luminance gain inequality is then derived from the Corrector reading (consult instrument manual).

Without disturbing this setting, check that the crossover point of the baseline coincides with the circle forming the centre of the limit diagram, and if necessary adjust the horizontal position to achieve this.

The peak-to-peak amplitude of the pair of lobes is then a measure of the chrominance luminance delay distortion. The pair of horizontal lines correspond to 200 ns, which may be considered as a limiting value for a high-quality TV system. This can be converted to 100 ns and 40 ns respectively by the use of the gain steps of the VOLTS FULL SCALE control. This diagram may also be used with a 10T chrominance pulse provided the indicated readings are halved. The limiting value for systems employing the 10T pulse is accordingly 100 ns.

Baseline lobes corresponding to the full-line portion of the diagram show a chrominance lag, termed positive by convention.

The broken lines denote a chrominance lead, that is a negative error.

B. When no 1478 Calibrated Chrominance Corrector is available it is still possible to make a measurement of the chrominance-luminance gain and delay inequalities, but with greatly reduced accuracy.

This method depends upon the fact that these quantities are calculable if the amplitudes of the two lobes into which the pulse baseline is deformed as a result of the distortion, are individually known. Consequently, one sets the black level of the signal under test along the 0.3 graticule line, and adjusts the gain until the peak of the 20T pulse just touches the 1.0 line; this normalizes the pulse amplitude. The display is then shifted vertically so that black level now lies along the 1.0 graticule line, when by shifting the trace horizontally the amplitudes of the two lobes can be read from the upper graduated scale (Figure 4b).

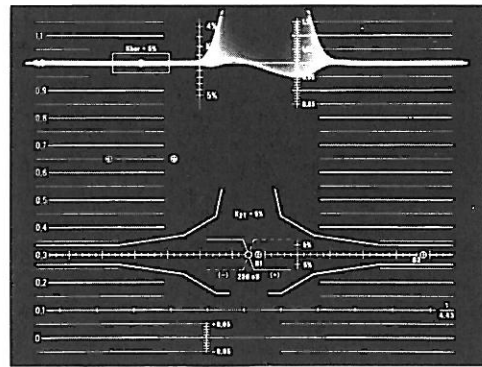
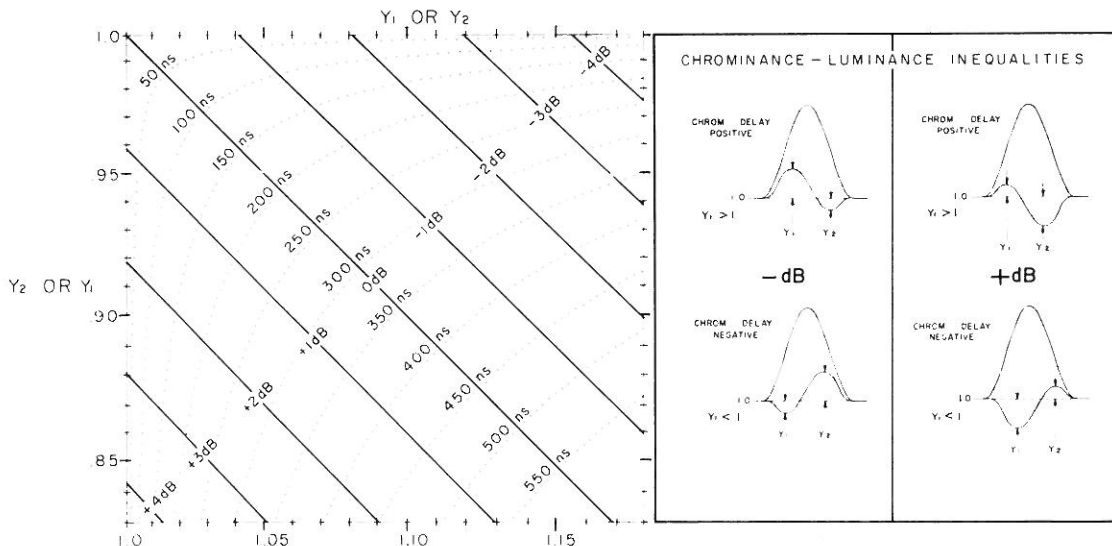

Figure 4b. Measurement of baseline lobes for use with the nomogram.

This pair of values, denoted Y_1 and Y_2 respectively, is transferred to the attached nomogram, from which the chrominance gain and delay inequalities are read. The table of diagrams inset should make the polarities of the distortions clear. Note that the nomogram is calibrated in terms of the actual figures read from the scale, so that zero lobe amplitude would be taken as 1.0.



As in the other measurements in this series, improved resolution is furnished by the use of the increased gain positions of the VOLTS FULL SCALE control. It is also helpful, if the means happen to be available for this purpose, to unlock the subcarrier frequency, which results in a considerably better defined chrominance envelope.

Although the graticule has been designed primarily for use with the 20T pulse, it may also be employed with a 10T pulse provided the readings of delay error are halved. The gain error readings are identical.

Part 5: Luminance Non-Linearity

Control Settings: MAG OFF
 Others As in Part 1.

Check that the test signal amplitude is correct, and adjust if necessary as given in Part 1.

Rotate the HORIZONTAL POSITION control until the staircase waveform appears in the centre of the display. Set the RESPONSE control to the DIFF'D STEP position, when a group of 5 sine-squared pulses will appear as a result of the differentiation of the staircase transitions.

Adjust black level to coincide with the 0.3 line, and shift the trace horizontally so that each pulse in turn is placed against the right-hand linear scale. Measure the amplitudes of the largest and the smallest as accurately as possible; let these be A_{max} and A_{min} respectively. Then the percentage non-linearity distortion is given by $\frac{A_{max} - A_{min}}{A_{max}} \times 100$, which may more conveniently be calculated if the amplitude of the largest pulse, A_{max} is made 7 graticule divisions (0.7V). The expression then simplifies to $(1 - 1.4 A_{min}) \times 100$.

In very many instances it is possible to utilize the VOLTS FULL SCALE VAR control to set the largest pulse to 10 graticule divisions by making it extend from the 0 line to the 1.0 line, when the distortion is given even more simply by $1 - A_{min} \times 100$, and the calculation required is minimal.

Another way of comparing the amplitudes of the differentiated pulses which is sometimes useful is to make use of the OVERLAY facility, by means of which any pair of pulses can be overlaid, and their amplitude difference made clearly visible. Both the increase of amplitude to 10 divisions and the use of the overlay facility are illustrated in Figure 5.

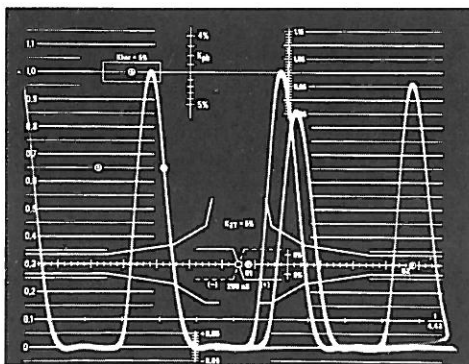

Figure 5. Measurement of differentiated pulse amplitudes using OVERLAY.

Part 6: Video Level Measurement

Control Settings: MAG OFF
 Others As under Part 1.
 Note: the VAR VOLTS FULL SCALE control must be in the CAL position.

A rapid estimate of the amplitude of the video signal can be obtained under operational conditions by the following procedure.

Rotate the HORIZONTAL POSITION knob until the mid-point of the bar top coincides with the right-hand vertical scale line. Adjust the VERTICAL POSITION control until the signal black level is in coincidence with point B₂ (Figure 6). The amplitude of the picture component can then be read against the graduated scale. At the same time the amplitude of the sync pulse can be read from the lower graduated scale.

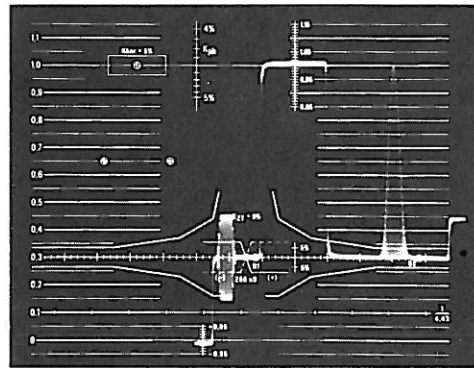

Figure 6. Check of video level.

References:

- 1: BBC and IBA: Specification of Television Standards for 625-Line System I Transmissions.
- 2: CMTT Document CMTT/187-E, Measurement of insertion gain by means of insertion of test line signals, November 1973.
- 3: CMTT Document CMTT/189-E Measurement of baseline distortion after trailing edges of step function signals, November 1973.

Appendix: Additional Measurements

Part 7. Check of Time Calibration (PAL Signal)

Controls: MAG x 50
 DISPLAY 10 μs/div or 5 μs/div
 LINE SELECTOR DIG; any convenient line
 FIELD 1 and 3, or 2 and 4
 SYNC INT; AFC or DIRECT

The time calibration of the waveform monitor with a PAL signal may be quickly and conveniently checked against a video signal by the following procedure. Set the controls as indicated, and rotate the HORIZONTAL POSITION control until the burst near the start of the trace is displayed as in Figure 7. In spite of the low repetition rate the crossover points of the superimposed sine waves will be quite clearly defined. It should then be possible to match these against the graduations provided for the purpose on the 0.1 graticule line. If any appreciable error is noticed, reference should be made to the instrument manual.

Application Notes—1480-Series (SN B060000-up)

With an NTSC signal, due to the absence of the 25 Hz offset found with PAL, there is, of course, no need to use a 2-field display rate.

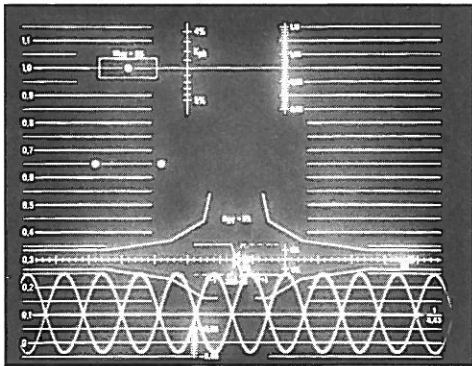

Figure 7. Check of time calibration (PAL).

Part 8. Measurement of Time of Fall of Bar

Controls: MAG x 50
 DISPLAY 5 μ s/div
 LINE SELECTOR DIG or 15 LINES
 according to test
 signal
 FIELD to suit test signal
(note: with a full-field test signal the 15
LINES facility provides a useful increase
in brightness).

In some countries it has been the practice to check the performance of equipment and links up to and beyond the nominal upper video frequency by the use of a 1T bar. This is preferred since the faster decrease in amplitude of its higher harmonics produces less severe ringing than is the case with the 1T pulse, and the resultant waveforms are considered to be easier to interpret.

In particular, the time of rise or fall of the 1T bar provides some indication of the equivalent rectangular bandwidth of the equipment under test, although the derivation of an exact figure from the output waveform is not straightforward unless the passband is Gaussian in shape.

The measurement of the time of fall of a bar waveform in the form of a video waveform is carried out as follows. Set the controls as given above and rotate the HORIZONTAL POSITION control until the trailing edge of the bar is within the display area. Adjust the gain so that the top and bottom of the bar fit exactly between the 0 and 1.0 graticule lines, then position the display so that the bottom of the bar lies on the 0.2 line, and at the same time the trailing edge coincides with the intersection of the 1.1 line and the graduated scale (Figure 8). The time of fall can then be read from the horizontal spacing between the small vertical 5% scale, and the point where the bar edge cuts the 0.3 graticule line.

CHARACTERISTICS

SCALE FACTOR—INPUT A and B 1.0 Volts Full Screen 1 ± 3 mV, 0.5 Volts Full Screen ± 15 mV, 0.2 V/F Screen ± 6 mV.

Ratio: INPUT A to INPUT B $1, \pm 0.002$, to 1, AUX VIDEO IN to INPUT A 1.5 ± 0.3 dB.

GAIN—INPUT A to AUX VIDEO OUT $1, \pm 0.005$, INPUT A to PIX MONITOR OUT $1, \pm 0.02$.

VARIABLE VOLTS FULL SCALE RANGE—Input signals between 0.7 volts and 2.0 volts can be adjusted to 1 volt equivalent display height.

Maximum Input Signal—for inspecification operation of AUX VIDEO OUT and PIX OUT, AC CPL'D: INPUT A and B 2.0 V P-P at any APL—Display distortion, 1.0 V P-P at any APL if both AUX VIDEO OUT and PIX OUT are terminated for distortion-free signal at those outputs. DC CPL'D: INPUT A and B ± 1.5 V, DC \pm Peak AC, AUX VIDEO IN ± 1.5 V, DC \pm Peak AC.

Maximum Output DC Voltage, AUX VIDEO OUT and PIX MONITOR OUT into 75 Ω — ± 0.5 V DC. Common Mode Rejection Ratio (A-B)—60 Hz ≥ 46 dB, 15 kHz ≥ 46 dB, 4.43 MHz ≥ 34 dB.

Frequency Response—FLAT including: INPUT A or INPUT B Through AUX VIDEO OUT or PIX MONITOR OUT from 50 kHz Reference: 50 kHz to 5 MHz $\pm 0.5\%$, 5 MHz to 10 MHz $\pm 0.5\%$, -3% . IRE: Conforms to IRE 1958 standard 23S-1. Attenuation at 4.43 MHz, ≥ 22 dB. LOW PASS: Attenuation ≥ 14 dB, 500 kHz and above. 3.58 MHz $\pm 1\%$ of FLAT at 3.58 MHz, 3 dB down at 3.1 to 3.4 MHz and 3.8 to 4.0 MHz. 4.43 MHz $\pm 1\%$ of FLAT at 4.43 MHz, 3 dB down at 3.9 to 4.1 MHz and 4.7 to 4.9 MHz. DIFF'D STEPS: Permits amplitude comparisons of risers on stair-step signal with automatic gain increase of 5 times, attenuation ≤ 2 dB from 0.4 to 0.5 MHz, attenuation ≥ 20 dB at 15 kHz and 2 MHz, attenuation ≥ 40 dB at 3.58 MHz and 4.43 MHz.

Linear Waveform Distortion—Pulse Preshoot, Pulse Overshoot, and Pulse Ringing $\leq 0.5\%$ of applied pulse amplitude. 25 μ s Bar Tilt $\leq 0.5\%$. Field Square Wave Tilt $\leq 1\%$, Pulse to Bar Ratio 0.99:1 to 1.01:1 or 0.99 to 1.01:1.

Non-Linear Waveform Distortion—Differential Gain Displayed $\leq 0.5\%$ at any APL, AUX VIDEO OUT and PIX MONITOR OUT $\leq 0.25\%$ at any APL. Differential Phase—AUX VIDEO OUT and PIX MONITOR OUT $\leq 0.25^\circ$ at any APL.

DC RESTORER—Mains Hum Attenuation, Slow $\leq 10\%$, Fast ≥ 26 dB. Shift caused by Presence or Absence of Burst ≤ 1 IRE or 7 mV.

Return Loss (With 75 Ω Termination)—INPUT A or B ≥ 40 dB, DC to 5 MHz, AUX VIDEO IN, AUX Video OUT, or PIX MONITOR OUT ≥ 34 dB, DC to 5 MHz.

Vertical Overscan—for 1 V Peak-to-Peak Composite Video Signal all specifications are valid at 1.0, 0.5, and 0.2 volts FULL SCALE, and any vertical position setting to 5 MHz.

Calibrator Accuracy—1 V $\pm 0.2\%$, 714 mV and 700 mV $\pm 0.5\%$.

Timebase Accuracy and Linearity—5 μ s/DIV and 10 μ s/DIV Accuracy Over Center 10 Div $\pm 1\%$, Linearity Overall $\pm 1\%$.

Magnified Timing and Linearity—For center 10 divisions of unmagnified sweep: $\pm 2\%$ accuracy, $\pm 2\%$ linearity.

2 FIELD Sweep Length and Linearity—12.7 div, ± 0.5 div.

FIELD SELECTOR—Positive selection of ODD (2 & 4) or EVEN (1 & 3) in 525/60 Systems. Display starts on selected field. Positive selection of 1, 2, 3, or 4, or 1 & 3, 2 & 4, in 625/50 Systems. Display starts on selected field.

LINE SELECTOR—VARIABLE Range: From approximately line 20 of the selected field to approximately line 8 of the next complementary field (example, line 20 or field 1, to line 8 of field 3). Lines intensified by the strobe in 2 FIELD display are the lines displayed in 5 μ s/DIV or 10 μ s/DIV. DIGITAL: Selects line 9/322 to line 22/335. 15 LINE: Identical to VARIABLE, except that 15 successive lines are displayed. ALL FIELDS: Time overlay of all fields any setting of the DISPLAY switch.

Sync Input Requirements—INT 200 mV peak-to-peak to 2 V peak-to-peak composite video. EXT 400 mV peak-to-peak to 2 V peak-to-peak composite video, 200 mV peak-to-peak to 8 V peak-to-peak composite sync. Return loss ≥ 46 dB down to 5 MHz.

Maximum Jitter with 1 V Peak-to-Peak Composite Video + (-26) dB White Noise—Direct 250 ns, AFC 90 ns.

Maximum Jitter with Missing Horizontal Sync Pulses— ≤ 15 ns/missing sync pulse (maximum of 10 consecutive horizontal sync pulses missing).

50 Hz/60 Hz Recognition—Automatically recognizes 50 Hz or 60 Hz scan in dual standard instrument.

Horizontal Trigger—AFC: Horiz. Frequency 15,750 ± 200 Hz, Lock-In Time ≤ 1 sec. Maximum Jitter with Respect to Input Sync 10 ns—Input composite Video or Composite Sync from a 140-series Generator, 12 ns—Variable APL, 12 ns—Variable APL & 4 V rms Hum, 30 ns—Variable APL & 4 V rms Hum + (-36) dB White Noise. Jitter Reduction with Respect to White Noise ≥ 8 dB.

DIRECT—Horiz. Frequency Range ≤ 20 kHz. Maximum Jitter with Respect to Input Sync 12 ns—input Composite Video or Composite Sync from a 140-series Generator, 20 ns—Variable APL, 20 ns—Variable APL & 4 V rms Hum, 90 ns—Variable APL & 4 V Hum $\pm (-36)$ dB White Noise.

EXTERNAL HORIZ IN—Sensitivity 0.5 V/div, Linearity $\pm 1\%$.

RGB/YRGB J9036—RGB Sweep Length Internally selected for $\frac{1}{2}$ normal sweep. YRGB Sweep Length internally selected for $\frac{1}{4}$ normal sweep.

WAVEFORM COMPARISON—LOCATE: Range sufficient to place LOCATE indication any place on 5 μ s/DIV, or unmagnified 10 μ s/DIV sweeps. OVERLAY: Range sufficient to overlay any selected portion of 5 μ s/DIV or unmagnified 10 μ s/DIV on any other portion.

LINE STROBE OUT—Strobe output of line or lines selected by VARIABLE, 15 LINE, or DIGITAL line selector modes and the DISPLAY switch. TTL-amplitude, ac-coupled. Time Constant = 1 μ F. 10 k Ω .

OPTION 1

10X Probe Channel—Scale Factor adjustable to 1 V peak-to-peak equivalent display height, GAIN Range $\pm 10\%$. Gain to AUX VIDEO: Unity, $\pm 3\%$, with gain adjusted for 1 V peak-to-peak equivalent display height. Tilt $\leq 5\%$ on 50 Hz square wave, High Frequency Response $\pm 1\%$, 25 Hz to 5 MHz, $\pm 3\%$, 5 MHz to 10 MHz. Referenced to 50 kHz. Differential Phase $\leq 0.25^\circ$ at any APL, Differential Gain $\leq 0.25\%$ at any APL, Input Resistance 1 M Ω , $\pm 2\%$, not including probe, Input RC Product 20 μ s, $\pm 0.5\%$, not including probe. BNC connector accepts most TEKTRONIX probes. P6065A probe recommended.

10X Probe Calibrator—Output Voltage 1 000 V ± 0.005 V or 0.995 to 1.005 V.

OPTION 4

TAPE T.W. SYNC Input—NTSC: Syncs to either a standard negative-going composite sync pulse of 3.5 V to 4.5 V in amplitude, or a 240 Hz negative-going tape recorder pulse, 1.5 V to 4.5 V in amplitude, 2,083 ms in width, and 4.166 ms in period. PAL: Syncs to negative-going 200 Hz tape recorder pulse, 1.5 to 4.5 V in amplitude 2.5 ms in width, and 5 ms in period.

Mains Voltage—Ranges: 100 VAC, 110 VAC, 120 VAC, 200 VAC, 220 VAC, 240 VAC $\pm 10\%$. Frequency: 48 Hz to 62 Hz, Max Power Consumption 75 W.

OPERATING TEMPERATURE—0 C to 50 C.

Dimensions and Weights

1480 C Series		
Height	8.25 in	21 cm
Width	8.50 in	21.6 cm
Depth	16.95 in	43.0 cm
Net Weight	21.5 lb	9.81 kg
Domestic shipping weight	≈ 28.5 lb	≈ 12.9 kg
Export-packed weight	≈ 41.5 lb	≈ 18.8 kg

Two 1480 C Series Waveform Monitors can be mounted side-by-side, or one mounted alongside an associated picture monitor in a standard 19-inch rack or console.

1480 R Series		
Height	5.25 in	13.3 cm
Width	19.0 in	48.2 cm
Rack Depth	18.0 in	45.7 cm
Net Weight	24.6 lb	11.2 kg
Domestic shipping weight	≈ 53.1 lb	≈ 24.1 kg
Export-packed weight	≈ 75.1 lb	≈ 34.1 kg

Instrument fits standard 19-inch rack.

ORDERING INFORMATION

1480C NTSC Waveform Monitor
1480R NTSC Waveform Monitor
1481C PAL Waveform Monitor
1481R PAL Waveform Monitor
1482C PAL M Waveform Monitor
1482R PAL M Waveform Monitor
1485C PAL/NTSC Dual Standard Waveform Monitor
1485R PAL/NTSC Dual Standard Waveform Monitor

Option 01 1 megohm, 20 pf probe input (probe not included)

Suggested Probe
P6065A 10X Probe, 6-ft, Order 010-6065-13
9-ft, Order 010-6105-05

Option 02 With carrying Case (Cabinet Version Only)

Option 03 With Blank CRT

Option 07 Slow Sweep

Option 08 Adds capability of recognizing four field sequence of SECAM (1481C, 1481R, 1485C, 1485R only)

TEKTRONIX Automatic Correction Products are also available for 525/60 NTSC systems.

Tektronix
COMMITTED TO EXCELLENCE

P.O. Box 500, Beaverton, Oregon 97077 U.S.A.

application notes

Tektronix®

COMMITTED TO EXCELLENCE



Time Base Fold Back, A Novel Improvement Over Double Triggering for Video Testing

By Charles W. Rhodes

In video testing, one is often comparing the amplitude of a test signal with the reference level provided by still another test signal. For example, the measurement of pulse-to-bar ratio using the 2T sine squared pulse and the line bar, or measuring chrominance-to-luminance gain equality with the modulated sine squared pulse and line bar. In both these cases, the amplitude of the pulse is measured with respect to the **midpoint** of the line bar. Where line time luminance distortion is present, which is not untypical in long distance video transmission systems, it is important to measure with respect to the bar's midpoint. This is recognized in CCIR, CMMT and other standard measuring procedures.

The usual measurement procedure is to adjust vertical gain so that bar midpoint equals 1.00 (CCIR scale) or 100 IRE units for NTSC signals, and then measure the amplitude of the pulse. At best this is an estimating process and involves the intermediate step, always subject to error, of setting gain correctly. In Figure 1, pulse-to-bar-ratio ≈ 0.965 , chrominance-to-luminance gain inequality $\approx -12.5\%$.

A far more accurate, faster and convenient procedure dispenses with critical gain setting of bar midpoint to the graticule, and offers a direct comparison of pulse-to-bar midpoint amplitudes. This is shown in Figure 2. Such displays are especially useful when either high precision in measurement is desired, or where exact equalization is being made on circuits.

Some laboratory oscilloscopes could provide such a display by the well known "double triggering" mode. In his book "Television Measurement Techniques" L. E. Weaver says ". . . greater accuracy is obtained in measurement of K_p (Pulse-to-bar) if the waveform monitor can be double triggered so that the centre of the bar appears vertically above the peak of the pulse." However, as such scopes were not designed to do this, it is just a bit tricky and inconvenient and in the case of in-service measurements, using insertion test signals, (VITS), conventional "double triggering" cannot be used at all.

Tektronix, recognizing the importance of this kind of measurement capability, has provided its new 1480 Series Waveform Monitor with "time base foldback". This new feature is easy to use and works on insertion test signals (VITS) which conventional "double triggering" cannot do. It is not limited to in-service testing, it is very valuable in laboratory measurements where high precision is required.

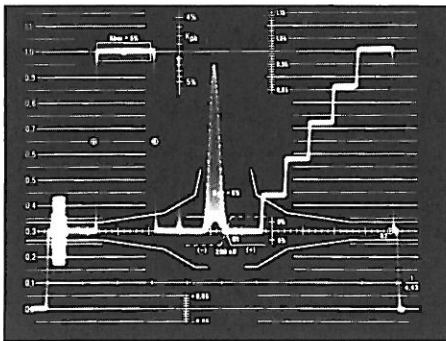

Figure 1.

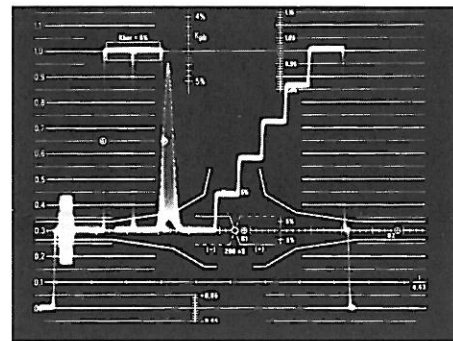

Figure 2.

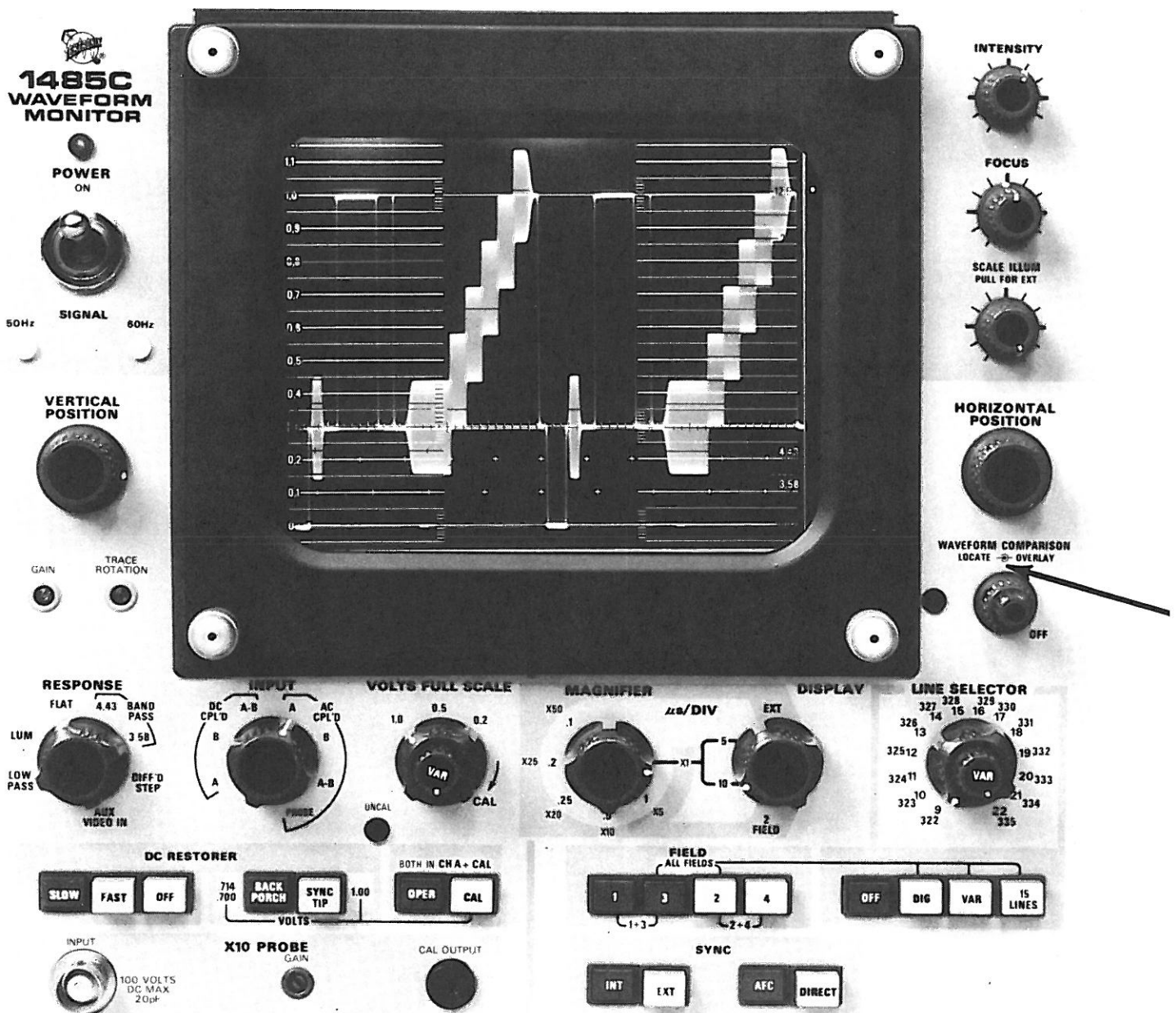

Figure 3.

Under the front panel label WAVEFORM COMPARISON two concentric controls, LOCATE and OVERLAY control the time base foldback circuit, see Figure 3. A red warning lamp is "ON" whenever the foldback is switched ON. A switch on the OVERLAY, outer concentric control (clockwise end) enables the foldback circuit and turns on the lamp as the control is rotated counter-clockwise.

To indicate precisely where the foldback will occur in time, an (intensity) marker is provided, whenever the circuit is

operating. Figure 4 shows the marker which is controlled by the LOCATE control.

The other (inner) control knob labeled, OVERLAY, moves the portion of the waveform to the right of the (intensity) marker. For example, the line bar lies to the left of the sine² pulse as shown in Figure 4, but the sine² pulse is easily moved to the left for comparison with the bar, which remains stationary. Once the sine² pulse is positioned at bar midpoint, very small differences in pulse and bar amplitudes can be resolved by

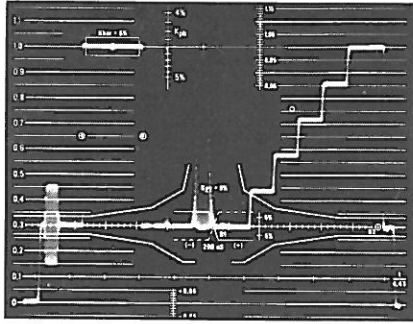

Figure 4.

magnifying the signal vertically. For example, a 1% difference in 2T pulse-to-bar ratio equals 1 IRE unit (7 mV CCIR) in a 1 volt, full scale deflection. This is barely discernible, but with X5 vertical expansion, a 1% pulse-to-bar amplitude inequality is displayed as a difference of 5 IRE units, as shown in Figure 5. A 1% difference in pulse-to-bar amplitudes is approximately $K_{p, b} = 0.25\%$. If a $K_{p, b}$ of 0.25% can be displayed as 5 IRE units, then one may easily resolve $K_{p, b}$ to, say 0.1% K.

For a measurement of chrominance-luminance gain inequality, a modulated sine² pulse-to-bar amplitude ratio of 1% equals 2% chrominance-luminance gain inequality. With X5 vertical expansion this small gain inequality (or less) is easily and accurately resolved.

Line time luminance nonlinearity is a measurement in which the relative amplitudes of the five differentiated step risers (spikes) are compared. See Figure 6. The differentiation of the risers provides a sensitive measurement of non-linear distortions affecting the luminance signal.

CCIR defines this distortion as $(1 - \frac{m}{M})$, where m equals the amplitude of the least spike and M the amplitude of the greatest spike.

In Figure 7, the time base foldback feature of TEKTRONIX 1480 Series is used to compare spike amplitudes. Here the least amplitude spike and greatest amplitude spikes are overlaid for easy comparison.

Line time distortion, e.g.: Tilt of the line bar, can be very accurately measured by comparing the amplitude of any part of the line bar with its midpoint amplitude. Here again, the calibrated vertical expansion of TEKTRONIX 1480 Series, combines with time base foldback to provide accurate resolution of small distortions. Figure 8 shows the line time distortion on bar top. Utilizing the Tektronix developed time base foldback and calibrated X5 vertical expansion it is possible to resolve 0.25% distortion, or $K = 0.25\%$.

Distortions as small as those cited above, do not represent significant picture impairments. However, a series of cascaded links each contributing these distortions will, at the downstream end, provide a degraded picture. Since these distortions are small on a per-link basis, they prove hard to measure without use of calibrated vertical expansion and time base foldback. Together, these features of TEKTRONIX 1480 Series Waveform Monitor provide state-of-the-art measurement capabilities for both laboratory and operational work.

¹Television Measurement Techniques, by L. E. Weaver; Peter Peregrinus Ltd., 1971

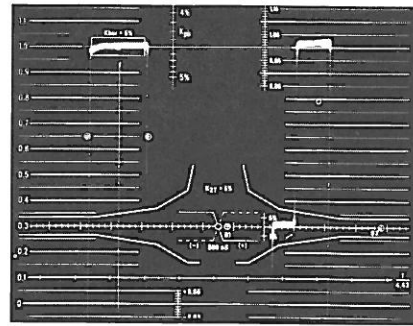

Figure 5.

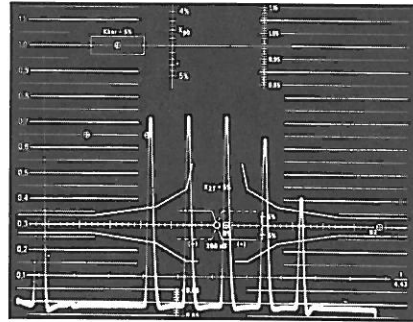

Figure 6.

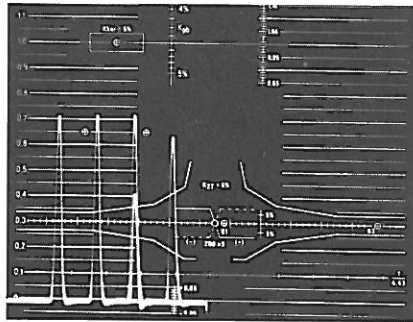

Figure 7.

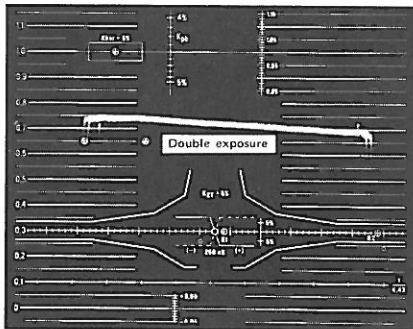



Figure 8.

Copyright © 1977, Tektronix, Inc. All rights reserved. Printed in U.S.A. Foreign and U.S.A. Products of Tektronix, Inc. are covered by Foreign and U.S.A. Patents and/or Patents Pending. Information in this publication supersedes all previously published material. Specification and price change privileges reserved TEKTRONIX, TEK, SCOPE-MOBILE, TELEQUIPMENT, and  are registered trademarks of Tektronix, Inc., P.O. Box 500, Beaverton, Oregon 97077, Phone: (Area Code 503) 644-0161, TWX 910-467-8708, Cable: TEKTRONIX. More than 50 Subsidiaries/Distributors around the world.

CHARACTERISTICS

SCALE FACTOR—INPUT A and B 1.0 Volts Full Screen 1 ± 3 mV, 0.5 Volts Full Screen ± 15 mV, 0.2 V/F Screen ± 6 mV.

Ratio: INPUT A to INPUT B $1, \pm 0.002$, to 1. AUX VIDEO IN to INPUT A 1.5 ± 0.3 dB.

GAIN—INPUT A to AUX VIDEO OUT $1, \pm 0.005$, INPUT A to PIX MONITOR OUT $1, + 0.02$.

VARIABLE VOLTS FULL SCALE RANGE—Input signals between 0.7 volts and 2.0 volts can be adjusted to 1 volt equivalent display height.

Maximum Input Signal—for inspecification operation of AUX VIDEO OUT and PIX OUT, AC CPL'D: INPUT A and B 2.0 V P-P at any APL—Display distortion 1.0 V P-P at any APL if both AUX VIDEO OUT and PIX OUT are terminated for distortion-free signal at those outputs. DC CPL'D INPUT A and B ± 1.5 V, DC \pm Peak AC, AUX VIDEO IN ± 1.5 V, DC \pm Peak AC.

Maximum Output DC Voltage, AUX VIDEO OUT and PIX MONITOR OUT into 75 Ω — ± 0.5 V DC. Common Mode Rejection Ratio (A-B)—60 Hz ≥ 46 dB, 15 kHz ≥ 46 dB, 4.43 MHz ≥ 34 dB.

Frequency Response—FLAT including: INPUT A or INPUT B Through AUX VIDEO OUT or PIX MONITOR OUT from 50 kHz Reference: 50 kHz to 5 MHz $\pm 0.5\%$, 5 MHz to 10 MHz $+ 0.5\%$, -3% . IRE: Conforms to IRE 1958 standard 23S-1. Attenuation at 4.43 MHz, ≥ 22 dB. LOW PASS: Attenuation ≥ 14 dB, 500 kHz and above. 3.58 MHz $\pm 1\%$ of FLAT at 3.58 MHz, 3 dB down at 3.1 to 3.4 MHz and 3.8 to 4.0 MHz. 4.43 MHz $\pm 1\%$ of FLAT at 4.43 MHz, 3 dB down at 3.9 to 4.1 MHz and 4.7 to 4.9 MHz. DIFF'D STEPS: Permits amplitude comparisons of risers on stair-step signal with automatic gain increase of 5 times, attenuation ≤ 2 dB from 0.4 to 0.5 MHz, attenuation ≥ 20 dB at 15 kHz and 2 MHz, attenuation ≥ 40 dB at 3.58 MHz and 4.43 MHz.

Linear Waveform Distortion—Pulse Preshoot, Pulse Overshoot, and Pulse Ringing $\leq 0.5\%$ of applied pulse amplitude. 25 μ s Bar Tilt $\leq 0.5\%$. Field Square Wave Tilt $\leq 1\%$. Pulse to Bar Ratio 0.99:1 to 1.01:1 or 0.99 to 1.01:1.

Non-Linear Waveform Distortion—Differential Gain Displayed $\leq 0.5\%$ at any APL, AUX VIDEO OUT and PIX MONITOR OUT $\leq 0.25\%$ at any APL. Differential Phase—AUX VIDEO OUT and PIX MONITOR OUT ≤ 0.25 at any APL.

DC RESTORER—Mains Hum Attenuation, Slow $\leq 10\%$. Fast ≥ 26 dB. Shift caused by Presence or Absence of Burst ≤ 1 IRE or 7 mV.

Return Loss (With 75 Ω Termination)—INPUT A or B ≥ 40 dB, DC to 5 MHz. AUX VIDEO IN, AUX Video OUT, or PIX MONITOR OUT ≥ 34 dB, DC to 5 MHz.

Vertical Overscan—for 1 V Peak-to-Peak Composite Video Signal all specifications are valid at 1.0, 0.5, and 0.2 volts FULL SCALE, and any vertical position setting to 5 MHz.

Calibrator Accuracy—1 V $\pm 0.2\%$, 714 mV and 700 mV $\pm 0.5\%$.

Timebase Accuracy and Linearity—5 μ s/DIV and 10 μ s/DIV Accuracy Over Center 10 Div $\pm 1\%$, Linearity Overall $\pm 1\%$.

Magnified Timing and Linearity—For center 10 divisions of unmagnified sweep, $\pm 2\%$ accuracy, $\pm 2\%$ linearity.

2 FIELD Sweep Length and Linearity—12.7 div, ± 0.5 div.

FIELD SELECTOR—Positive selection of ODD (2 & 4) or EVEN (1 & 3) in 525/60 Systems. Display starts on selected field. Positive selection of 1, 2, 3, or 4, or 1 & 3, 2 & 4, in 625/50 Systems. Display starts on selected field.

LINE SELECTOR—VARIABLE Range: From approximately line 20 of the selected field to approximately line 8 of the next complementary field (example, line 20 or field 1, to line 8 of field 3). Lines intensified by the strobe in 2 FIELD display are the lines displayed in 5 μ s/DIV or 10 μ s/DIV. DIGITAL: Selects line 9/322 to line 22/335. 15 LINE: Identical to VARIABLE, except that 15 successive lines are displayed. ALL FIELDS: Time overlay of all fields any setting of the DISPLAY switch.

Sync Input Requirements—INT 200 mV peak-to-peak to 2 V peak-to-peak composite video. EXT 400 mV peak-to-peak to 2 V peak-to-peak composite video. 200 mV peak-to-peak to 8 V peak-to-peak composite sync. Return loss ≥ 46 dB down to 5 MHz.

Maximum Jitter with 1 V Peak-to-Peak Composite Video + (-26) dB White Noise—Direct 250 ns, AFC 90 ns.

Maximum Jitter with Missing Horizontal Sync Pulses— ≤ 15 ns/missing sync pulse (maximum of 10 consecutive horizontal sync pulses missing).

50 Hz/60 Hz Recognition—Automatically recognizes 50 Hz or 60 Hz scan in dual standard instrument 50.

Horizontal Trigger—AFC: Horiz. Frequency 15,750 ± 200 Hz, Lock-In Time ≤ 1 sec. Maximum Jitter with Respect to Input Sync 10 ns—Input composite Video or Composite Sync from a 140-series Generator, 12 ns—Variable APL, 12 ns—Variable APL & 4 V rms Hum, 30 ns—Variable APL & 4 V rms Hum + (-36) dB White Noise. Jitter Reduction with Respect to White Noise ≥ 8 dB.

DIRECT—Horiz. Frequency Range ≤ 20 kHz. Maximum Jitter with Respect to Input Sync 12 ns—input Composite Video or Composite Sync from a 140-series Generator, 20 ns—Variable APL, 20 ns—Variable APL & 4 V rms Hum, 90 ns—Variable APL & 4 V rms Hum + (-36) dB White Noise.

EXTERNAL HORIZ IN—Sensitivity 0.5 V/div. Linearity $\pm 1\%$.

RGB/YRGB J9036—RGB Sweep Length Internally selected for $\frac{1}{2}$ normal sweep. YRGB Sweep Length internally selected for $\frac{1}{4}$ normal sweep.

WAVEFORM COMPARISON—LOCATE: Range sufficient to place LOCATE indication any place on 5 μ s/DIV, or unmagnified 10 μ s/DIV sweeps. OVERLAY: Range sufficient to overlay any selected portion of 5 μ s/DIV or unmagnified 10 μ s/DIV on any other portion.

LINE STROBE OUT—Strobe output of line or lines selected by VARIABLE, 15 LINE, or DIGITAL line selector modes and the DISPLAY switch. TTL-amplitude, ac-coupled. Time Constant = 1 μ F, 10 k Ω .

OPTION 1

10X Probe Channel—Scale Factor adjustable to 1 V peak-to-peak equivalent display height, GAIN Range $\pm 10\%$. Gain to AUX VIDEO: Unity, $\pm 3\%$, with gain adjusted for 1 V peak-to-peak equivalent display height. Tilt $\leq 5\%$ on 50 Hz square wave. High Frequency Response $\pm 1\%$, 25 Hz to 5 MHz $\pm 3\%$, 5 MHz to 10 MHz. Referenced to 50 kHz. Differential Phase ≤ 0.25 at any APL. Differential Gain $\leq 0.25\%$ at any APL. Input Resistance 1 M Ω , $\pm 2\%$, not including probe. Input RC Product 20 μ s, $\pm 0.5\%$, not including probe. BNC connector accepts most TEKTRONIX probes P6065A probe recommended.

10X Probe Calibrator—Output Voltage 1 000 V ± 0.005 V or 0.995 to 1 005 V.

OPTION 4

TAPE T.W. SYNC Input—NTSC: Syncs to either a standard negative-going composite sync pulse of 3.5 V to 4.5 V in amplitude, or a 240 Hz negative-going tape recorder pulse, 1.5 V to 4.5 V in amplitude, 2,083 ms in width, and 4 166 ms in period. PAL: Syncs to negative-going 200 Hz tape recorder pulse, 1.5 to 4.5 V in amplitude 2.5 ms in width, and 5 ms in period.

Mains Voltage—Ranges: 100 VAC, 110 VAC, 120 VAC, 200 VAC, 220 VAC, 240 VAC $\pm 10\%$. Frequency: 48 Hz to 62 Hz, Max Power Consumption 75 W.

OPERATING TEMPERATURE—0 C to 50 C.

Dimensions and Weights

1480 C Series		
Height	8.25 in	21 cm
Width	8.50 in	21.6 cm
Depth	16.95 in	43.0 cm
Net Weight	21.5 lb	9.81 kg
Domestic shipping weight	≈ 28.5 lb	≈ 12.9 kg
Export-packed weight	≈ 41.5 lb	≈ 18.8 kg

Two 1480 C Series Waveform Monitors can be mounted side-by-side, or one mounted alongside an associated picture monitor in a standard 19-inch rack or console.

1480 R Series		
Height	5.25 in	13.3 cm
Width	19.0 in	48.2 cm
Rack Depth	18.0 in	45.7 cm
Net Weight	24.6 lb	11.2 kg
Domestic shipping weight	≈ 53.1 lb	≈ 24.1 kg
Export-packed weight	≈ 75.1 lb	≈ 34.1 kg

Instrument fits standard 19-inch rack.

ORDERING INFORMATION

- 1480C NTSC Waveform Monitor
- 1480R NTSC Waveform Monitor
- 1481C PAL Waveform Monitor
- 1481R PAL Waveform Monitor
- 1482C PAL M Waveform Monitor
- 1482R PAL M Waveform Monitor
- 1485C PAL/NTSC Dual Standard Waveform Monitor
- 1485R PAL/NTSC Dual Standard Waveform Monitor

- Option 01 1 megohm, 20 pf probe input (probe not included)
Suggested Probe
P6065A 10X Probe 6-ft. Order
010-6065-13
9-ft. Order 010-6105-05
- Option 02 With carrying Case (Cabinet Version Only)
- Option 03 With Blank CRT
- Option 07 Slow Sweep
- Option 08 Adds capability of recognizing four field sequence of SECAM (1481C, 1481R, 1485C, 1485R only)

TEKTRONIX Automatic Correction Products are also available for 525/60 NTSC systems.



P. O. Box 500, Beaverton, Oregon 97077 U.S.A.

application notes

Tektronix®

COMMITTED TO EXCELLENCE

no. 14

Superimposing Alternate Field ITS to Improve In-Service Testing

Since their introduction, the use of Insertion Test Signals for in-service measurement has revolutionized television distribution system measurement techniques. For the first time it became possible to test a distribution system while it was in use. The new TEKTRONIX 1480 Series Waveform Monitor is especially designed to even further these techniques. One of the major innovative display modes added to the 1480 Series is ALL FIELDS which superimposes all, or part of alternate fields. This new feature presents some very distinct advantages:

1. Simultaneous viewing of all four International Insertion Test Signals (or other selected interval lines).
2. Comparison of ITS signals applied at separate points.
3. An in-service method of displaying field time distortions.

Simultaneous ITS

Methods of in-service testing, in common use, all require accurate Insertion Test Signals located on specific field blanking interval lines. Because of this requirement the International Radio Consultative Committee, C.C.I.R., has established 4 lines for internationally defined test signals. In addition lines are assigned, and used, for national test signals. Because of their importance to the overall quality of television processing circuits, ITS are being more closely monitored. The 1480 Series Waveform Monitor ALL FIELDS display is an ideal method of observing these signals. When used in the 10 μ second per division (2 H) sweep rate all four of the international Insertion Test Signals (lines 17, 18, 330 and 331) can be viewed at once. See Figure 1.

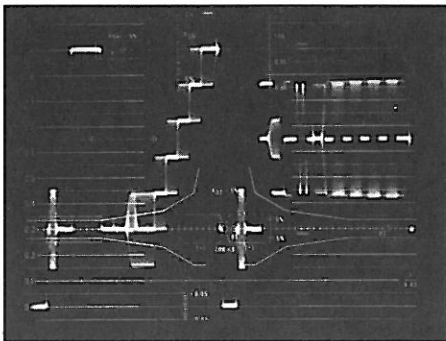

Figure 1. All 4 international insertion test signals displayed simultaneously.

Comparing ITS

It is relatively easy to assess the distortion of the entire distribution system by K-rating it with the Insertion Test Signal, added

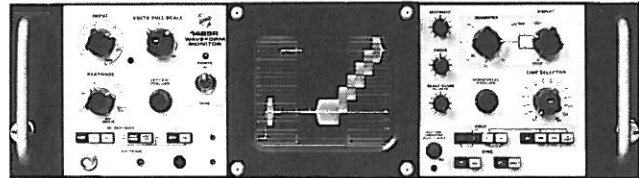

Figure 2. 1485R Front Panel.

at the point of origin. However, this does not isolate individual problem areas. Although not new, the idea of inserting test signals at different points and comparing them takes on a new dimension when the test signal can be directly overlaid for comparison.

This display mode is selected through the ALL FIELDS selection located at the lower right corner of the front panel. The novel circuitry involved makes it possible to overlay the even and odd fields to display a single line, pair of adjacent lines or both fields (displayed as a single field in the 2 FIELD DISPLAY mode).

Using this display technique opens up an outstanding test method for distribution system analysis. All that is required, in addition to the ALL FIELDS display, is a method to delete the original Insertion Test Signal on one field and reinsert an identical test signal. Precautions must be taken that the outputs of any Insertion Test Signal generators used for this type of measurement are as closely matched as current technology permits. In addition the coincidence of the Insertion Test Signals is extremely important. The TEKTRONIX 148 Insertion Test Signal Generator has a front panel screwdriver adjustment, labeled INSERTION DELAY, that may be adjusted for coincidence. Matching generator is in itself an excellent use of the 1480 Series overlaid fields display with one generator inserting in even field interval, while the other is inserting only in the odd field intervals.

For purposes of illustration, the United Kingdom Insertion Test Signal 1 (lines 19 and 332) is used and a determination as to which line will traverse the entire system and which will be deleted and subsequently reinserted has to be made. Arbitrarily, for purposes of illustration, Line 19 (even fields) is the system reference, while Line 332 (odd fields) is used for the reinserted test signal.

The usefulness of this technique is enhanced by its universality. The size of the system under test can be anywhere from a Studio-to-Transmitter Link to a transcontinental network. In addition, since only the difference between the Insertion Test Signals is to be considered, any point in the system can be selected for the reinsertion point, with monitoring at any downstream point desired. This leaves one major consideration; the monitoring operator must know where reinsertion is occurring, but with modern distribution systems this is no problem.

the composite test signal. Position the leading edge of the bar to the ascending arrow. Vertically position the blanking level to point B on the 0 IRE Unit reference line.

Insertion gain is measured at the bar midpoint, see Figure 1.

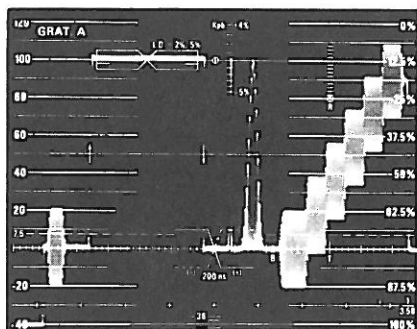

Figure 1. Checking Insertion Gain and Line Time Distortion, Insertion Gain = unity, L.D. = 0%.

Line Time Distortion

Position the composite test signal bar leading edge to the ascending arrow, with blanking level on point B. If insertion gain is off, set the VARIABLE VOLTS FULL SCALE so that the bar top passes through 100 IRE at its midpoint. See Figure 1. To measure line time distortion, check the largest deviation of the bar top (tilt or rounding) within the box. This box ignores the first and last 1 μsec where short time distortions may be observed. The box provides 2% and 5% L.D. (line time distortion) scales.

To increase resolution, change the VOLTS FULL SCALE (without changing VARIABLE VOLTS FULL SCALE) to 0.5 for 2½% and 1% limits to the L.D. measurement box, or to 0.2 for 1% and 0.4% limits. See Figure 2.

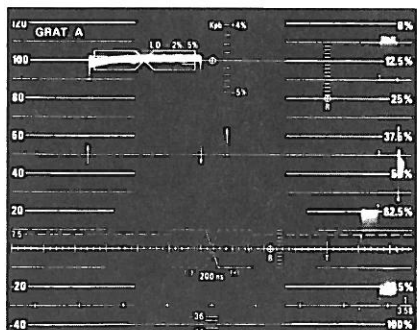

Figure 2. Line Time Distortion with increased gain, L.D. = 0.4%.

Short Time Distortion

At the time of this writing, the weighting characteristics to be used to develop an outline for the 2T pulse and the T step

transition are under discussion by industry committees. For this reason, Graticule A does not contain the traditional outline for the 2T pulse. Instead, an external graticule (Graticule B), containing a scaling of the outline given in CCIR Recommendation 421-1, is provided for 1480's equipped with Graticule A. If a different weighting factor is adopted for 525/60 standards, new graticules and different nomenclature will be required. Current plans call for changing the 2T pulse distortion nomenclature to P_{2T} , and T step distortion nomenclature to S_{1T} to reflect these different weighting factors.

Many broadcast organizations presently use and are familiar with (2T) pulse-to-bar amplitude ratio measurements and, for this reason, the K_{pb} scale is included on this new graticule. The K_{pb} scale is non-linear. It conforms with CCIR Recommendation 421-1.

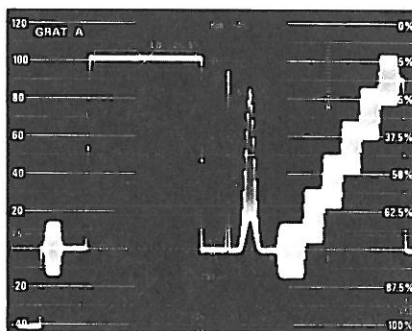

Figure 3. K_{pb} measurement, $K_{pb} = -1.5\%$.

K_{pb} . To measure pulse-to-bar ratio, place the composite test signal bar leading edge over the ascending arrow and the blanking level on the 0 IRE Unit reference line at point B. If insertion gain is incorrect (bar midpoint not at 100 IRE), use the 1480 VARIABLE VOLTS FULL SCALE to correct this condition.

The pulse-to-bar measurement is from bar midpoint to peak 2T pulse amplitude expressed in + or - percent. See Figure 3.

K_{2T} . If insertion gain is incorrect, adjust the VARIABLE VOLTS FULL SCALE to compensate. Use a 200 nsec/div time base and position the 2T pulse beneath the K_{pb} scale. This measurement uses Graticule B. To illuminate the external Graticule B, pull the Scale Illumination knob. See Figure 4.

The mask corresponds to 5%. If greater resolution is desired, change the VOLTS FULL SCALE (without moving VARIABLE) to 0.5 for 2½% or 0.2 for 1% mask limits. See Figure 5.

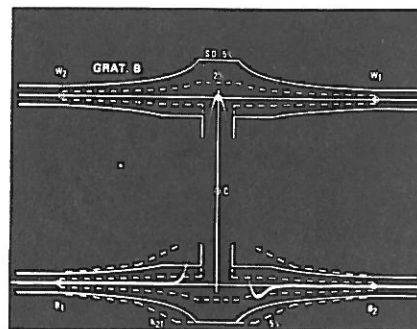

Figure 4. K_{2T} measurement, $K_{2T} = 2\%$.

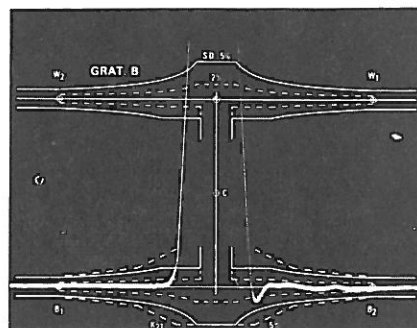

Figure 5. K_{2T} measurement with increased gain, $K_{2T} > 1\%$.

Short Time Waveform Distortion (SD).

IEEE Trial Standard 511-1974 describes the technique for measuring short time waveform distortion (SD) in detail. Graticule B includes the mask prescribed in the Trial Standard. The 1480's POSITION controls are adjusted so that the transition passes through points B (blanking) and C, and the vertical gain is set so that white level of the bar passes through point W. Some control interaction will take place. Using the 200 nsec/div time base, an undistorted 1T transition will lie perfectly centered in the mask. See Figure 6.

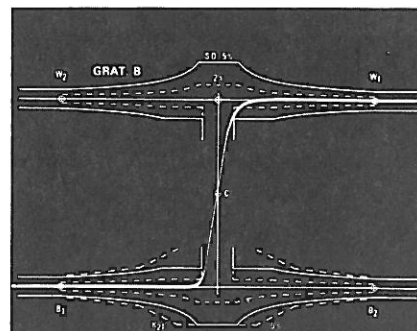

Figure 6. S.D. using 2T pulse rising transient, S.D. ≈ 2%.

The FCC Composite VITS (§73.699, Figure 15) provides for a 2T bar. This signal cannot be used to measure SD. It does, however, include a 2T pulse which

Application Notes—1480-Series (SN B060000-up)

may be used to measure SD using the 2T pulse mask of Graticule B. See Figure 4.

A 5% value of SD is used as the basis of the mask in Graticule B, again this is in conformity with the IEEE Trial Standard 511-1974.

In a linear system, one need only measure one transition (rising or falling), but in practical circuits, non-linear distortions may affect the transitions very differently. This provides a clue to the presence of such non-linear distortions. It is good, therefore, to measure both transitions. Each might be characterized by a different value of SD.

Chrominance—Luminance Gain Inequality

Check insertion gain. If it is not unity, use the VARIABLE VOLTS FULL SCALE to get a 100-IRE Unit blanking-to-bar center amplitude. Use a 1 μ s/DIV time base and check the peak amplitude and baseline offset of the 12.5T modulated sine-squared pulse. If other forms of distortion are not present, the variation in peak amplitude and the baseline offset, at pulse center, will be equal. See Figure 7.

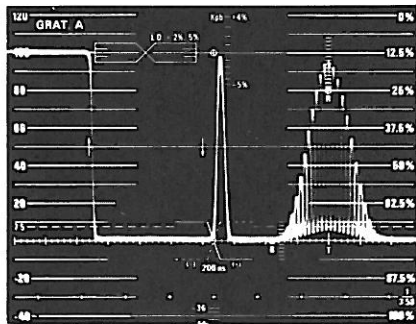

Figure 7. Chrominance to Luminance Gain Inequality measurement, C/L Gain Inequality = 9%.

Assuming that the 12.5T pulse baseline is symmetrical (negligible chrominance—luminance delay), as shown in Figure 7, gain inequality can be measured using either the vernier scale (-10 to +10 IRE) or the R scale to the right of the pulse. Each division of these scales equals 2 IRE Units. Chrominance—luminance (chrominance-to-luminance) gain inequality is equal to twice the difference between 100 IRE Units and peak displayed amplitude of the 12.5T modulated sine-squared pulse, expressed in percentage.

This measurement can also be made by using a TEKTRONIX 1478 Calibrated Chrominance Level Corrector in the 1480 Aux Video Out-Aux Video In

configuration. (See Television Application Note #17, "The Auxiliary Video Facility of the 1480-Series of Waveform Monitors," by L. E. Weaver.)

Chrominance—Luminance Delay

If the chrominance—luminance gain inequality is negligible, or has been annulled, for example, using the TEKTRONIX 1478 Calibrated Chrominance Level Corrector (See Television Products Application Note #10, "Chrominance to Luminance Gain Correction and Delay Measurements"), chrominance—luminance delay inequality can be read directly from Graticule A.

Use a 1 μ s/DIV time base and horizontally center the 12.5T modulated sine-squared pulse. Set displayed pulse amplitude for 100 IRE Units (blanking level to pulse peak amplitude), if necessary. Vertically set the blanking level on the graticule 0 IRE Unit reference line. See Figure 8.

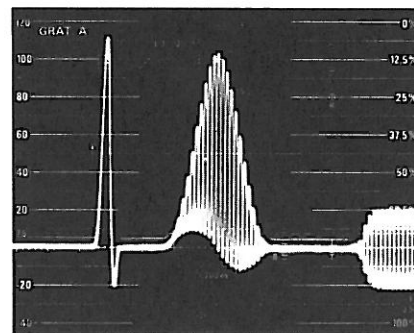

Figure 8. Chrominance to Luminance Delay Inequality measurement, C/L Delay Inequality = 200nsec.

If, as in Figure 8, chrominance—luminance gain inequality is negligible, chrominance—luminance delay inequality is easily measured by comparing the symmetrical sinusoidal baseline aberration to the special delay scale. The plus-to-minus transition (solid line) is used with a positive chrominance delay (chrominance lag), while the minus-to-plus transition (dashed line) is for negative chrominance delay (chrominance lead). A full scale symmetrical transition, such as the one in Figure 8, equals 200 nsec of delay inequality.

Since chrominance—luminance delay inequality may be considerably less than 200 nsec, the calibrated vertical expansion of the 1480 Waveform Monitor allows two and five times resolution increase. Setting VOLTS FULL SCALE to 0.5 changes the delay scale to 100 nsec peak-to-peak; 0.2 VOLTS FULL SCALE increases the delay inequality

scale resolution to 40 nsec. See Figure 9.

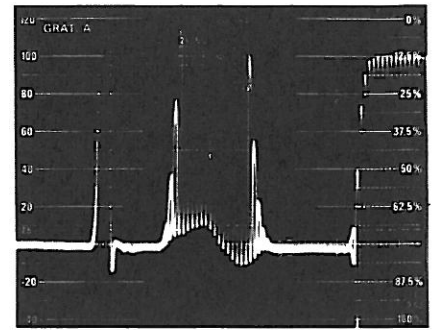

Figure 9. Chrominance to Luminance Delay Inequality measurement, with increased gain, C/L Delay Inequality = 40 nsec.

Luminance Non-linearity

Luminance non-linearity is easily measured using the differentiated step display mode of the 1480 Waveform Monitor. Position the composite waveform staircase to graticule center and switch to DIFF'D STEPS. Adjust the VARIABLE VOLTS FULL SCALE for a 100 IRE Unit amplitude of the largest step (spike). See Figure 10.

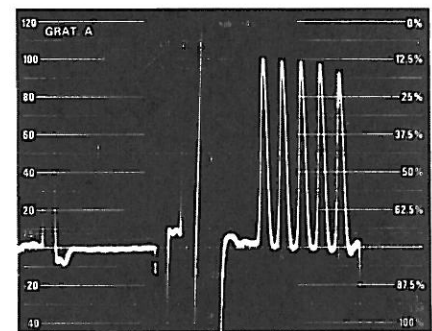

Figure 10. Luminance Non-linearity measured with the Differentiated Step Display, Luminance Non-linearity = 6%.

Horizontally position the smallest step (spike) to the R scale (2 IRE Units/div) and read the percentage of non-linearity directly. The formula for determining luminance non-linearity, in %, according

to the CCIR, is $1 - \frac{m}{M} \times 100$. M is the

amplitude of the largest step, and m is the smallest step. This formula is conveniently simplified by holding M at 100 and subtracting m, or $100 - m$.

It is also possible to fold back the 1480's sweep to display m and M overlaid. (See Television Application Note #13, "Time Base Fold Back, A Novel Improvement Over Double Triggering for Video Testing" by Charles W. Rhodes.)

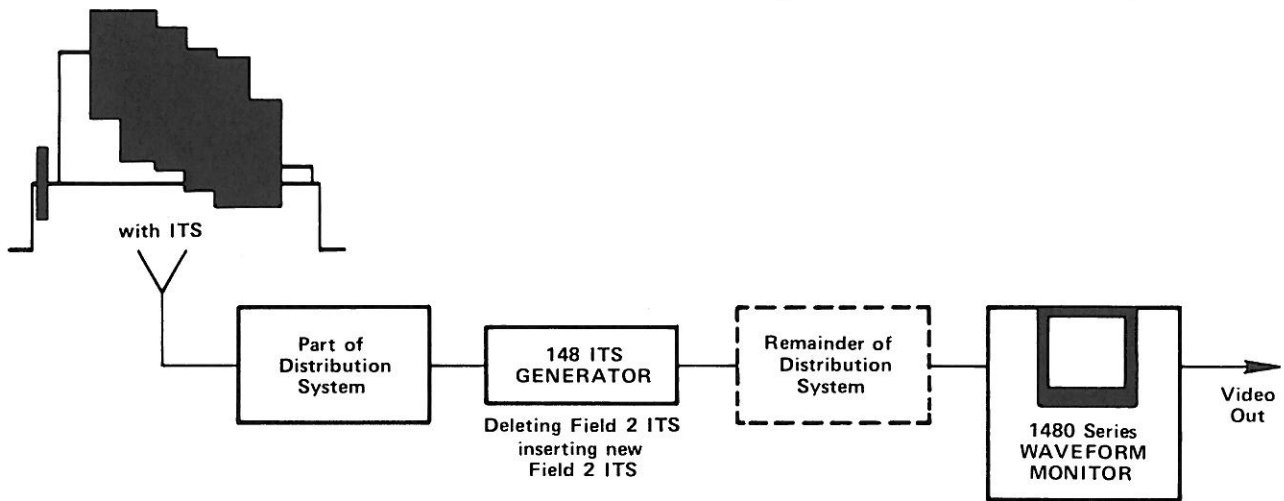

Figure 3. Simplified diagram of a distribution system, showing reinsertion of field 2 ITS.

Now that the test signal assignments have been made, all that remains is the comparison. Since the even field (line 19) test signal has traversed the entire system it will display maximum distortion and should be identified prior to the actual overlaying. When ALL FIELDS is selected any difference is immediately apparent. See Figure 4.

Once the ALL FIELDS display is obtained several options, aside from the obvious visual comparison, remain. One, comparative K-rating, is especially valuable if the monitoring point is physically removed from the point of reinsertion, allowing some degradation of both test signals. Figure 5 shows K_{pb} and K_{2T} of the overlaid test signals, note that both displayed signals are degraded and that three distinct pieces of information are available.

1. Total distribution system distortion (K-rating of the Line 19 test signal).
2. Distortion from the point of reinsertion to the monitoring point (K-rating of the Line 332 test signal).
3. Distortion from the point of origin to the point of reinsertion (difference in the K-ratings).

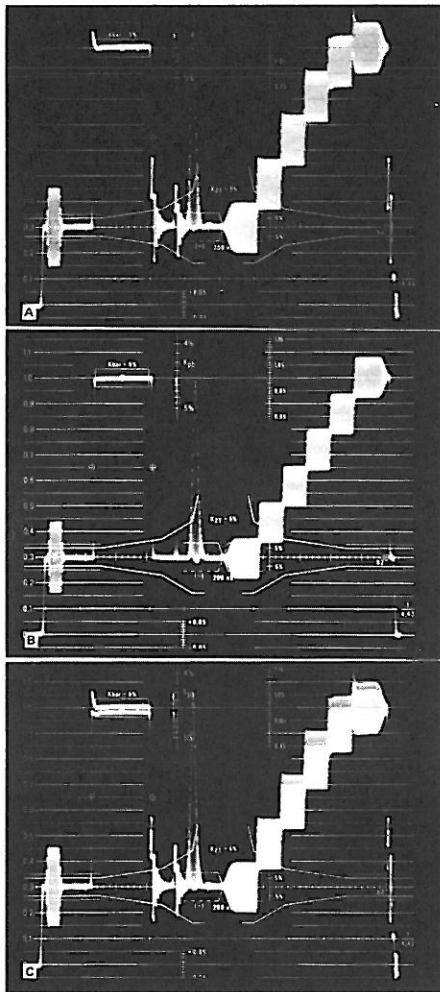

Figure 4. a. Insertion test signal through full system.
 b. Insertion test signal reinserted.
 c. Signals a and b overlaid.

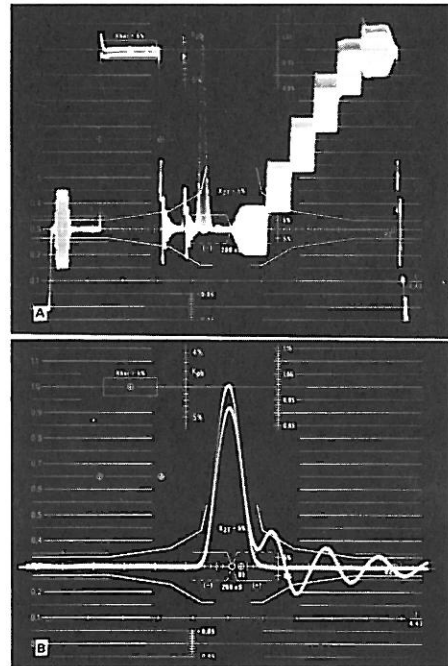

Figure 5. a. K_{pb} of the overlaid ITS.
 b. K_{2T} of the overlaid ITS.

Application Notes—1480-Series (SN B060000-up)

Observing Field Time Distortion

It is normally not possible to observe field time distortion on an in-service basis. However, with the ALL FIELDS display mode of the 1480 Series Waveform Monitor it can now be done with relative ease. It should be noted at this time that the most sensitive test signal for this purpose is a $52 \mu\text{S}$ white bar, however this is not normally an Insertion Test Signal. Figure 6 shows the field time distortion (tilt) of a white bar signal.

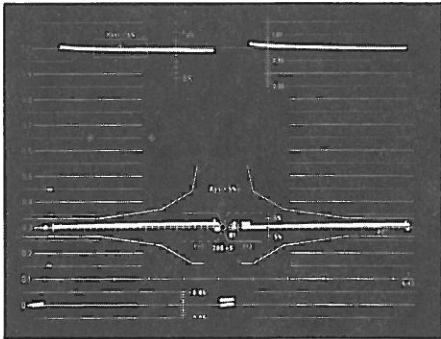

Figure 6. Field time distortion observed with a white bar.

To make a similar, though less sensitive, in-service observation one Insertion Test Signal must be deleted. For an example, let line 17 be deleted while lines 18, 330 and 331 continue to carry the assigned test signals. By displaying ALL FIELDS, as shown in Figure 7 observe that lines 18 and 331 display different video levels. This is field time distortion, which may also be thought of as a residue of line 330 energy due to the tilt (field time dis-

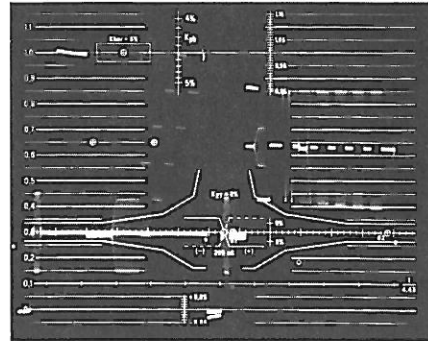



Figure 7. Field time distortion observed with ITS.

tortion). Sensitivity of the test is dependent on the energy contained in the test signal; the energy available on line 330 is less than that of a white bar signal.

By comparing the results obtained in Figure 6 and 7 it is obvious that the in-service measurement is less sensitive than using the optimum signal. However, this is still a powerful measurement technique, in that it can be performed in-service, using established test signals.

With the inclusion of ALL FIELDS and the other new display features, covered by the other Application Notes in this series, the 1480 Series Waveform Monitor has widened the area of in-service measurement. Tests that were either impossible or at best estimations, when performed in-service, are now accurate and time saving.

Copyright © 1977, Tektronix, Inc. All rights reserved. Printed in U.S.A. Foreign and U.S.A. Products of Tektronix, Inc. are covered by Foreign and U.S.A. Patents and/or Patents Pending. Information in this publication supersedes all previously published material. Specification and price change privileges reserved. TEKTRONIX, TEK, SCOPE-MOBILE, TELEQUIPMENT, and  are registered trademarks of Tektronix, Inc., P.O. Box 500, Beaverton, Oregon 97077, Phone: (Area Code 503) 644-0161, TWX: 910-467-8708. Cable: TEKTRONIX. More than 50 Subsidiaries/Distributors around the world.

CHARACTERISTICS

SCALE FACTOR—INPUT A and B 1.0 Volts Full Screen ± 3 mV, 0.5 Volts Full Screen ± 15 mV, 0.2 V/F Screen ± 6 mV.

Ratio: INPUT A to INPUT B 1, ± 0.002 , to 1, AUX VIDEO IN to INPUT A 1.5 ± 0.3 dB.

GAIN—INPUT A to AUX VIDEO OUT 1, ± 0.005 . INPUT A to PIX MONITOR OUT 1, ± 0.02 .

VARIABLE VOLTS FULL SCALE RANGE—Input signals between 0.7 volts and 2.0 volts can be adjusted to 1 volt equivalent display height.

Maximum Input Signal—for inspecification operation of AUX VIDEO OUT and PIX OUT. AC CPL'D: INPUT A and B 2.0 V P-P at any APL—Display distortion. 1.0 V P-P at any APL if both AUX VIDEO OUT and PIX OUT are terminated for distortion-free signal at those outputs. DC CPL'D: INPUT A and B ± 1.5 V, DC \pm Peak AC, AUX VIDEO IN ± 1.5 V, DC \pm Peak AC.

Maximum Output DC Voltage, AUX VIDEO OUT and PIX MONITOR OUT into 75 Ω — ± 0.5 V DC. Common Mode Rejection Ratio (A-B)—60 Hz ≥ 46 dB, 15 kHz ≥ 46 dB, 4.43 MHz ≥ 34 dB.

Frequency Response—FLAT including: INPUT A or INPUT B Through AUX VIDEO OUT or PIX MONITOR OUT from 50 kHz Reference: 50 kHz to 5 MHz $\pm 0.5\%$, 5 MHz to 10 MHz $\pm 0.5\%$, -3% . IRE: Conforms to IRE 1958 standard 23S-1. Attenuation at 4.43 MHz, ≥ 22 dB. LOW PASS: Attenuation ≥ 14 dB, 500 kHz and above. 3.58 MHz $\pm 1\%$ of FLAT at 3.58 MHz, 3 dB down at 3.1 to 3.4 MHz and 3.8 to 4.0 MHz. 4.43 MHz $\pm 1\%$ of FLAT at 4.43 MHz, 3 dB down at 3.9 to 4.1 MHz and 4.7 to 4.9 MHz. DIFF'D STEPS: Permits amplitude comparisons of risers on staircase signal with automatic gain increase of 5 times, attenuation ≤ 2 dB from 0.4 to 0.5 MHz, attenuation ≥ 20 dB at 15 kHz and 2 MHz, attenuation ≥ 40 dB at 3.58 MHz and 4.43 MHz.

Linear Waveform Distortion—Pulse Preshoot, Pulse Overshoot, and Pulse Ringing $\leq 0.5\%$ of applied pulse amplitude. 25 μ s Bar Tilt $\leq 0.5\%$, Field Square Wave Tilt $\leq 1\%$, Pulse to Bar Ratio 0.99:1 to 1.01:1 or 0.99 to 1.01:1.

Non-Linear Waveform Distortion—Differential Gain Displayed $\leq 0.5\%$ at any APL, AUX VIDEO OUT and PIX MONITOR OUT $\leq 0.25\%$ at any APL. Differential Phase—AUX VIDEO OUT and PIX MONITOR OUT ≤ 0.25 at any APL.

DC RESTORER—Mains Hum Attenuation, Slow $\leq 10\%$, Fast ≥ 26 dB. Shift caused by Presence or Absence of Burst ≤ 1 IRE or 7 mV.

Return Loss (With 75 Ω Termination)—INPUT A or B ≥ 40 dB, DC to 5 MHz, AUX VIDEO IN, AUX Video OUT, or PIX MONITOR OUT ≥ 34 dB, DC to 5 MHz.

Vertical Overscan—for 1 V Peak-to-Peak Composite Video Signal all specifications are valid at 1.0, 0.5, and 0.2 volts FULL SCALE, and any vertical position setting to 5 MHz.

Calibrator Accuracy—1 V $\pm 0.2\%$, 714 mV and 700 mV $\pm 0.5\%$.

Timebase Accuracy and Linearity—5 μ s/DIV and 10 μ s/DIV Accuracy Over Center 10 Div $\pm 1\%$, Linearity Overall $\pm 1\%$.

Magnified Timing and Linearity—For center 10 divisions of unmagnified sweep: $\pm 2\%$ accuracy, $\pm 2\%$ linearity.

2 FIELD Sweep Length and Linearity—12.7 div, ± 0.5 div.

FIELD SELECTOR—Positive selection of ODD (2 & 4) or EVEN (1 & 3) in 525/60 Systems Display starts on selected field. Positive selection of 1, 2, 3, or 4, or 1 & 3, 2 & 4, in 625/50 Systems Display starts on selected field.

LINE SELECTOR—VARIABLE Range: From approximately line 20 of the selected field to approximately line 8 of the next complementary field (example, line 20 or field 1, to line 8 of field 3). Lines intensified by the strobe in 2 FIELD display are the lines displayed in 5 μ s/DIV or 10 μ s/DIV. DIGITAL: Selects line 9/322 to line 22/335. 15 LINE: Identical to VARIABLE, except that 15 successive lines are displayed. ALL FIELDS: Time overlay of all fields any setting of the DISPLAY switch.

Sync Input Requirements—INT 200 mV peak-to-peak to 2 V peak-to-peak composite video. EXT 400 mV peak-to-peak to 2 V peak-to-peak composite video, 200 mV peak-to-peak to 8 V peak-to-peak composite sync. Return loss ≥ 46 dB down to 5 MHz.

Maximum Jitter with 1 V Peak-to-Peak Composite Video + (-26) dB White Noise—Direct 250 ns, AFC 90 ns.

Maximum Jitter with Missing Horizontal Sync Pulses— ≤ 15 ns/missing sync pulse (maximum of 10 consecutive horizontal sync pulses missing).

50 Hz/60 Hz Recognition—Automatically recognizes 50 Hz or 60 Hz scan in dual standard instrument.

Horizontal Trigger—AFC: Horiz. Frequency 15.750 ± 200 Hz, Lock-In Time ≤ 1 sec. Maximum Jitter with Respect to Input Sync 10 ns—Input composite Video or Composite Sync from a 140-series Generator, 12 ns—Variable APL & 4 V rms Hum, 30 ns—Variable APL & 4 V rms Hum + (-36) dB White Noise. Jitter Reduction with Respect to White Noise ≥ 8 dB.

DIRECT—Horiz. Frequency Range ≤ 20 kHz. Maximum Jitter with Respect to Input Sync 12 ns—input Composite Video or Composite Sync from a 140-series Generator, 20 ns—Variable APL, 20 ns—Variable APL & 4 V rms Hum, 90 ns—Variable APL & 4 V Hum $\pm (-36)$ dB White Noise.

EXTERNAL HORIZ IN—Sensitivity 0.5 V/div, Linearity $\pm 1\%$.

RGB/YRGB J9036—RGB Sweep Length Internally selected for $\frac{1}{2}$ normal sweep. YRGB Sweep Length internally selected for $\frac{1}{4}$ normal sweep.

WAVEFORM COMPARISON—LOCATE: Range sufficient to place LOCATE indication any place on 5 μ s/DIV, or unmagnified 10 μ s/DIV sweeps. OVERLAY: Range sufficient to overlay any selected portion of 5 μ s/DIV or unmagnified 10 μ s/DIV on any other portion.

LINE STROBE OUT—Strobe output of line or lines selected by VARIABLE, 15 LINE, or DIGITAL line selector modes and the DISPLAY switch. TTL-amplitude, ac-coupled. Time Constant = 1 μ F, 10 k Ω .

OPTION 1

10X Probe Channel—Scale Factor adjustable to 1 V peak-to-peak equivalent display height, GAIN Range $\pm 10\%$. Gain to AUX VIDEO: Unity, $\pm 3\%$, with gain adjusted for 1 V peak-to-peak equivalent display height. Tilt $\leq 5\%$ on 50 Hz square wave, High Frequency Response $\pm 1\%$, 25 Hz to 5 MHz. $\pm 3\%$, 5 MHz to 10 MHz. Referenced to 50 kHz. Differential Phase ≤ 0.25 at any APL. Differential Gain $\leq 0.25\%$ at any APL. Input Resistance 1 M Ω , $\pm 2\%$, not including probe. Input RC Product 20 μ s, $\pm 0.5\%$, not including probe. BNC connector accepts most TEKTRONIX probes. P6065A probe recommended.

10X Probe Calibrator—Output Voltage 1 000 V ± 0.005 V or 0.995 to 1.005 V.

OPTION 4

TAPE T.W. SYNC Input—NTSC: Syncs to either a standard negative-going composite sync pulse of 3.5 V to 4.5 V in amplitude, or a 240 Hz negative-going tape recorder pulse, 1.5 V to 4.5 V in amplitude, 2.083 ms in width, and 4.166 ms in period. PAL: Syncs to negative-going 200 Hz tape recorder pulse. 1.5 to 4.5 V in amplitude 2.5 ms in width, and 5 ms in period.

Mains Voltage—Ranges. 100 VAC, 110 VAC, 120 VAC, 200 VAC, 220 VAC, 240 VAC $\pm 10\%$. Frequency: 48 Hz to 62 Hz, Max Power Consumption 75 W.

OPERATING TEMPERATURE—0 C to 50 $^{\circ}$ C.

Dimensions and Weights

1480 C Series		
Height	8 25 in	21 cm
Width	8 50 in	21 6 cm
Depth	16 95 in	43 0 cm
Net Weight	21 5 lb	9 81 kg
Domestic shipping weight	≈ 28 5 lb	≈ 12 9 kg
Export-packed weight	≈ 41 5 lb	≈ 18 8 kg

Two 1480 C Series Waveform Monitors can be mounted side-by-side, or one mounted alongside an associated picture monitor in a standard 19-inch rack or console.

1480 R Series		
Height	5 25 in	13 3 cm
Width	19 0 in	48 2 cm
Rack Depth	18 0 in	45 7 cm
Net Weight	24 6 lb	11 2 kg
Domestic shipping weight	≈ 53 1 lb	≈ 24 1 kg
Export-packed weight	≈ 75 1 lb	≈ 34 1 kg

Instrument fits standard 19-inch rack.

ORDERING INFORMATION

1480C NTSC Waveform Monitor
1480R NTSC Waveform Monitor
1481C PAL Waveform Monitor
1481R PAL Waveform Monitor
1482C PAL M Waveform Monitor
1482R PAL M Waveform Monitor
1485C PAL/NTSC Dual Standard Waveform Monitor
1485R PAL/NTSC Dual Standard Waveform Monitor

Option 01 1 megohm, 20 pf probe input (probe not included)
Suggested Probe
P6065A 10X Probe, 6-ft. Order 010-6065-13
9-ft. Order 010-6105-05

Option 02 With carrying Case (Cabinet Version Only)

Option 03 With Blank CRT

Option 07 Slow Sweep

Option 08 Adds capability of recognizing four field sequence of SECAM (1481C, 1481R, 1485C, 1485R only)

TEKTRONIX Automatic Correction Products are also available for 525/60 NTSC systems

Tektronix
COMMITTED TO EXCELLENCE

P.O. Box 500, Beaverton, Oregon 97077 U.S.A.



Enhanced Video Measurement Capability Using the 15 Line Display of the TEKTRONIX 1480 Series Waveform Monitors

television application note no.15

As the television industry has come of age the viewing public, along with the technicians and engineers of the industry, has become an extremely critical judge of picture quality. This critical judgement forces the broadcaster to adopt ever more sophisticated measurement techniques, requiring greater accuracy in test methods and test equipment. For years the same general video measurement techniques, or difficult special tests, have been used on video tape recorders. This would be fine if only machine characteristics, such as frequency response, transient response or signal non-linearity were involved. However, many of the important performance characteristics of modern VTR systems are related to the individual heads, their equalizers and preamplifiers, rather than to overall VTR performance. This application note deals primarily with assessing the performance of individual heads, but does not ignore such VTR machine problems as time base instability, jitter, distorted or missing sync pulses, or field time distortion.

In order to accurately evaluate VTR head performance of modern quadruplex machines, a novel waveform monitor

display mode had to be adopted. The TEKTRONIX 1480-Series Waveform Monitors incorporate this new 15-line display mode. While its primary application is to VTR head evaluation, other applications where selected groups of lines must be looked at provides this mode with extra versatility. This display mode selects 15 adjacent lines and displays them one on top of the other as shown in Figure 1. Using the 15-line display mode provides a much brighter display than a line selected one (1H) or two (2H) line display, but still does not confuse the operator with extraneous information, as would happen in a full field display.

The following paragraphs will show how to use the 1480-Series Waveform Monitor 15-line display mode to evaluate each individual head of a quadruplex VTR for signal-to-noise ratio and non-linear distortion (differential gain and differential phase). In addition to the 1480-Series Waveform Monitor a noise measurement system, such as the TEKTRONIX 1430, or the 147/147A (NTSC), 148 (PAL) or 148-M(PAL-M), and a Vectorscope 520/520A (NTSC), 521/521A (PAL) or 522/522A(PAL-M) are required.

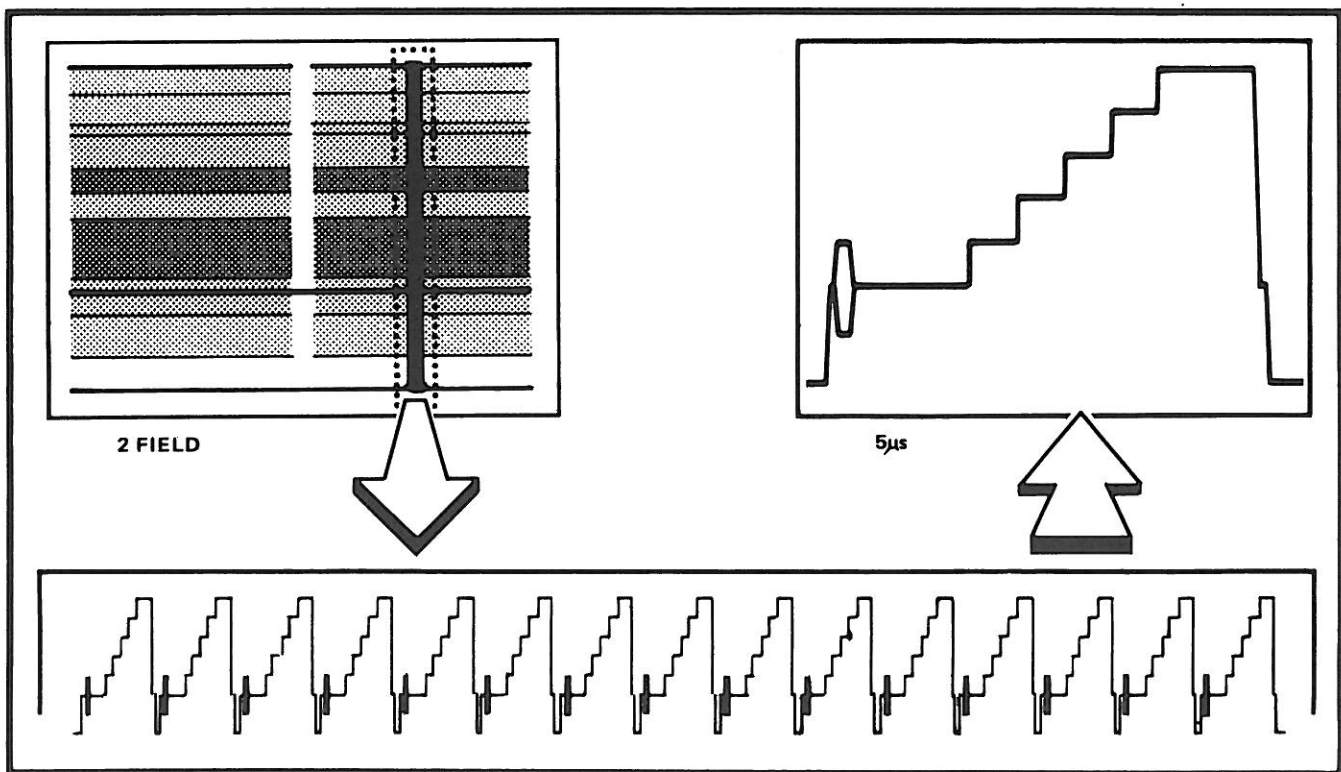

Figure 1. 15 line display mode. Any 15 lines may be selected and displayed overlaid.

The Monitor and the VTR

Figure 2 shows the interconnections for routine operation and maintenance of a broadcast videotape recorder. The video signal is provided to the Waveform Monitor from a signal selector panel in the VTR. The Waveform Monitor displays this signal, and also provides a unique video signal to a picture monitor. In any of the line selector modes, digital, variable, or 15-line, the lines being displayed on the Waveform Monitor appear intensified on the picture monitor. In the 2 field mode of the Waveform Monitor, these selected lines are displayed as an intensified portion of the sweep, as shown in Figure 3. This is an excellent way to exactly locate the lines of interest within a picture. Select the desired mode and simply adjust the VARIABLE LINE SELECTOR control until the lines of interest are intensified, and those will be the lines displayed when the time base is changed to give a one or two-line display. The picture monitor always shows those intensified lines being displayed on the Waveform Monitor independent of the horizontal sweep mode of the Waveform Monitor.

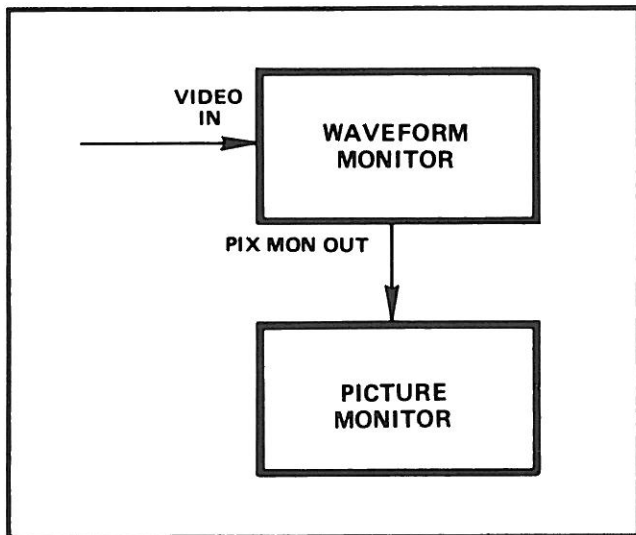

Figure 2. Equipment setup for normal VTR operation and maintenance.

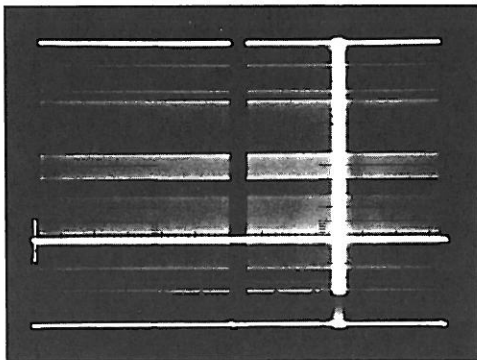

Figure 3. Two field display with selected lines intensified.

In a quadruplex videotape recorder, each head pass covers just a bit more than 15 lines, so by correctly placing the 15-line display the Waveform Monitor can show each head individually or it can show the transition between any two consecutive heads. Head identification (and correct placement of the intensified portion) may at first seem difficult, but is actually quite easily done. By slightly misadjusting

the VTR's female tape guide and viewing the signal before any time base correction is applied, the characteristic scalloping of the picture seen on the picture monitor indicates the area scanned by each head.

Figure 4 shows the picture monitor display used to locate each head. When the VTR is operating in the home track mode the first sixteen lines of the field, starting with the serrated vertical pulse, are covered by head number 4. The first lines shown in figure 4 are from head number 2, making the sequence of head passes 4, 2, 3, 1, 4, etc. The brightened portion in figure 4 indicates that we are looking at head number 1. After the head has been located in this manner, the female tape guide is returned to its correct position and the desired test or adjustment is made.

If it is desired to compare the characteristics of two adjacent heads, the brightened portion of the picture is positioned to straddle the two heads, and the Waveform Monitor then displays the output of these heads overlaid one on another for easy comparison. Figure 5 shows two heads of a quadruplex videotape machine overlaid to show differential chroma gain between them.

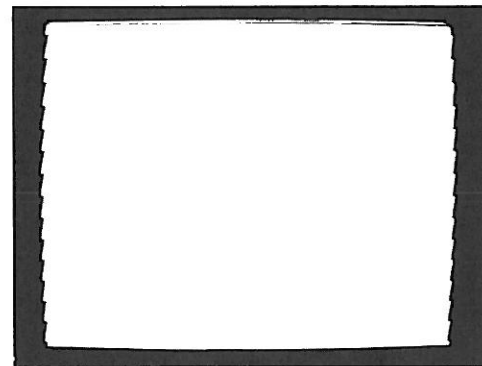

Figure 4. Picture monitor display showing selected 15 lines. Notice how easily each head of the VTR can be identified.



Figure 5. Difference in differential gain between two adjacent video heads as observed on a 1480-Series Waveform Monitor.

Head Signal-to-Noise Ratio Measurements

Video signal-to-noise ratio of each individual head can be measured using the 1480-Series Waveform Monitor 15-line display mode in conjunction with the Tektronix developed noise measurement by comparison technique. A TEKTRONIX 147/147A NTSC Test Signal Generator or 148/148-M Insertion Test Signal Generator (PAL) or (PAL-M), which include the noise measurement feature, or the TEKTRONIX 1430 Random Noise Measuring Set can be used. In the case of the 147/

Application Notes—1480-Series (SN B060000-up)

147A, 148, or 148-M, external low pass filters should be employed between the generator and the 1480-Series Waveform Monitor. Use a 4.2 MHz low pass filter with the 147/147A or 148-M and a 5 MHz low pass filter with the 148. The 1430 contains its own filter and does not require the use of external filters.

Figure 6 shows the equipment connections for signal-to-noise measurements on a head-by-head basis. A length of tape is recorded with a flat field signal and played back. The TEKTRONIX 1430, 147/147A, 148 or 148-M provides the calibrated noise insertion for comparison with the VTR head noise. The video head of interest is selected by observing the picture monitor. The noise generator is then adjusted to match the head noise.

The 15-line display mode allows excellent accuracy for this comparison by giving a bright "stacked" display of all 15 lines, rather than trying to evaluate one line as was previously done. This improved resolution provides greater accuracy as well as the increase in brightness.

It is not necessary to correctly adjust the female tape guide before making the head signal-to-noise measurement because accurate guide positioning is not necessary to this measurement. Each head can be checked and the results compared.

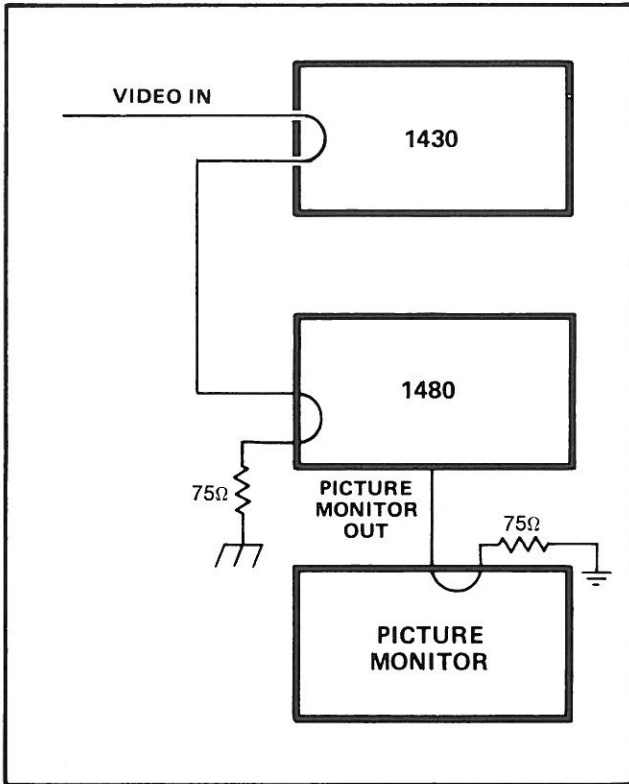

Figure 6. Equipment connections for head-by-head noise measurement.

Radical differences in signal-to-noise ratio between heads may indicate that the headwheel has reached the end of its useful life.

This is especially true in production houses where the same machine is used for playback in productions requiring multiple generations. Each generation will be more noisy than the former, and the end result may have unacceptable noise banding from just one noisy head. This measuring technique will determine whether the head should be replaced before

expensive studio production time is wasted. Figures 7 through 10 show the results of this noise measuring technique on the headwheel of a typical VTR using a TEKTRONIX 1430 Noise Measuring Set.

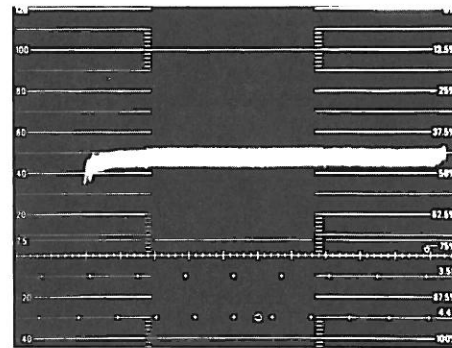

Figure 7. Head #1 noise measurement —50 dB noise.

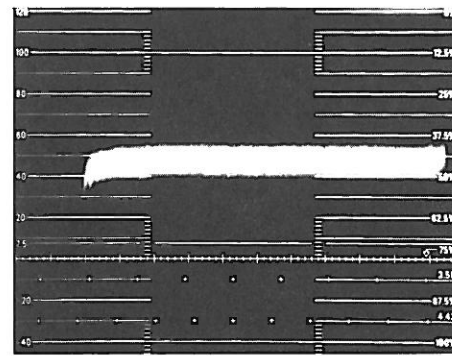

Figure 8. Head #2 noise measurement —44 dB noise.

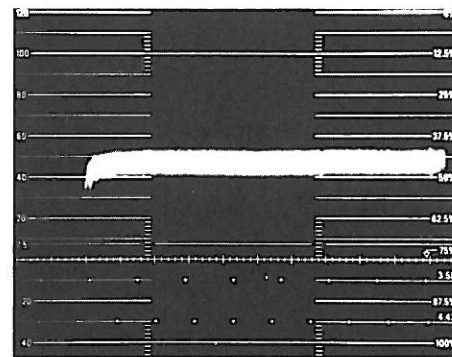

Figure 9. Head #3 noise measurement —45 dB noise.

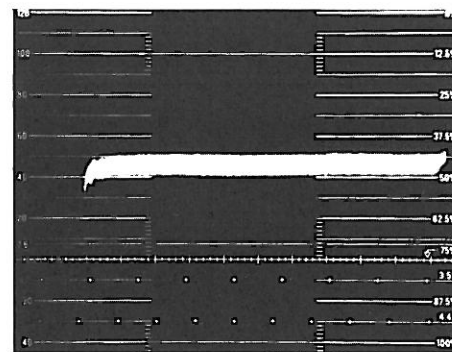

Figure 10. Head #4 noise measurement —51 dB noise.

Figure 13. Differential Gain

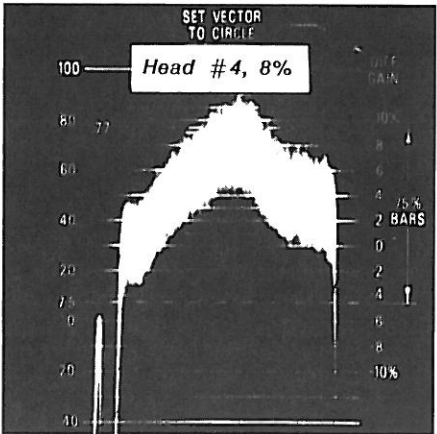
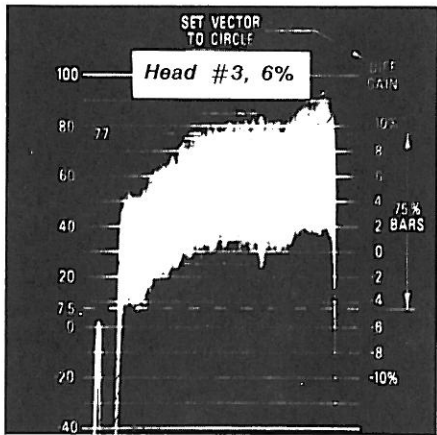
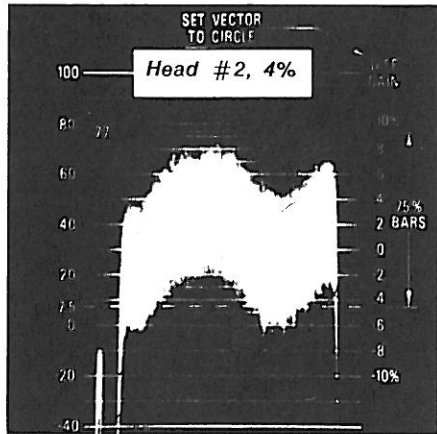
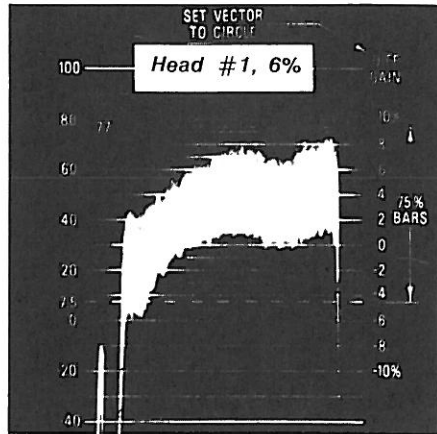
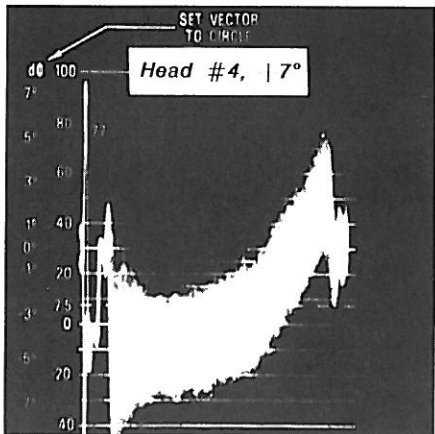
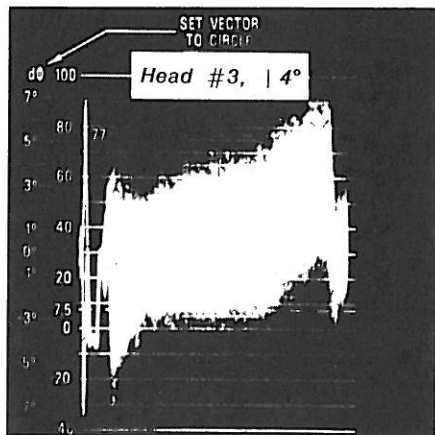
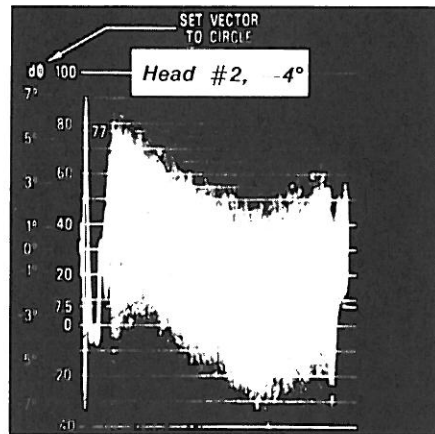
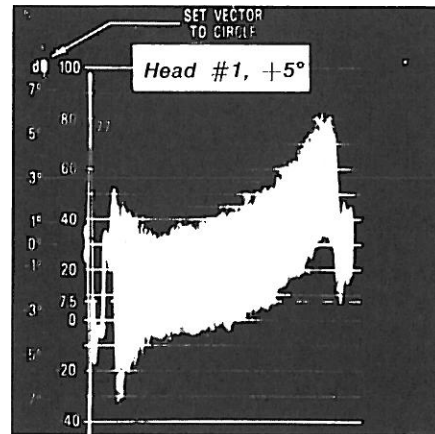

Figure 14. Differential Phase



Checking Time Base Stability

The 1480 includes automatic frequency control of the time base so jitter can be measured. Heretofore this has not been possible on a Waveform Monitor. A 1480-Series Waveform Monitor operating in the 15-line mode gives a display of very nearly one millisecond of picture signal in either a 525/60 or 625/50 system. This is a convenient time frame in which to make time base jitter measurements. Select the 15-line, 10 μ sec/div display, set the sync selector to internal, AFC on and magnify the display to observe the leading edge of sync. Any time base instability will be readily apparent. This measurement is particularly useful in applications where a mechanical scanner is used to reproduce video, such as a quadruplex or helical scan videotape recorder. By "windowing" down through the field, mechanical problems causing instability will be readily apparent. Figure 15 shows jitter in the playback signal of a helical scan VTR caused by a dirty head drum bearing.

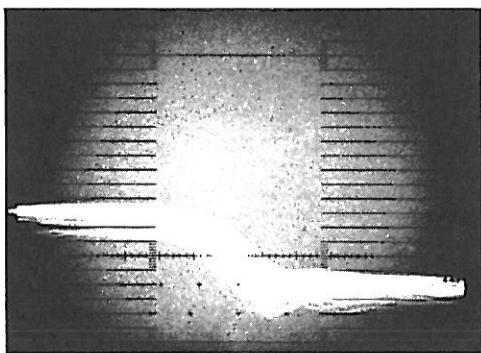

Figure 15. Time base jitter of a helical scan VTR. The one millisecond time frame of the 15-line display is convenient for this type of measurement.

Transmitter Measurements

The 1480-Series of Waveform Monitors provides the capability for all the usual transmitter measurements made with a Waveform Monitor, and the unique Z-axis signal gating provided to a vectorscope allows some unusual distortions sometimes

found in television visual transmitters to be observed. One of the most apparent of these distortions is field rate phase modulation of chrominance. This distortion appears as a hue shift for the first few lines of picture, usually after vertical blanking. Figure 16 shows the demodulated output of a television transmitter with about 3° of chrominance phase modulation.

The 15-line display mode of the TEKTRONIX 1480-Series of Waveform Monitors is a valuable tool for many unique video measurements, providing previously unavailable capabilities for measurement in videotape recorders, transmitters and other areas of television operations. The ability to analyze the characteristics of each head of a videotape recorder provides an excellent means for optimizing record/reproduce performance. The individual head noise measurement technique can save costly production time by indicating the need for head replacement well in advance of noise banding in multiple generations. Field rate related distortions are also readily apparent using the expanded measurement capabilities of the TEKTRONIX 1480-Series of Television Waveform Monitors.

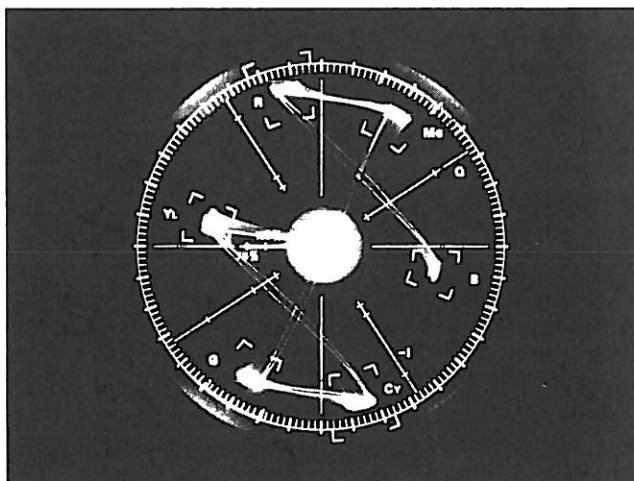

Figure 16. Field time chrominance phase modulation of a visual transmitter.

application notes



Verifying the Bruch Blanking Sequence

Verification of the Bruch blanking sequence falls into the area of routine testing and, though necessary, is tedious. Using the accurate four-field selection of a 1480-Series Waveform Monitor can reduce the time required for this test. In essence, only 4 lines need to be observed to accurately determine if the sequence is occurring correctly on each field. Figure 1 shows the PAL Bruch blanking sequence and identifies lines 6, 310, 319 and 623. If the Bruch blanking sequence for PAL-M (525/60 used in Brazil) is being verified, using a PAL-M 1480-Series Waveform Monitor, disregard Figure 1. Lines 8, 259, 270, and 522 will be substituted for those above. Table 1, in the Verification Procedure, is prepared for both 625/50 PAL and 525/60 PAL-M.

The Verification Procedure that follows displays portions of two fields. The first field whose sync triggers the time base, corresponds to the field selected by front panel pushbutton. The investigation of the blanking sequence takes place at the end of this field and the beginning of the next field. Figure 2 shows field 4 followed by field 1 (FIELD 4 selected).

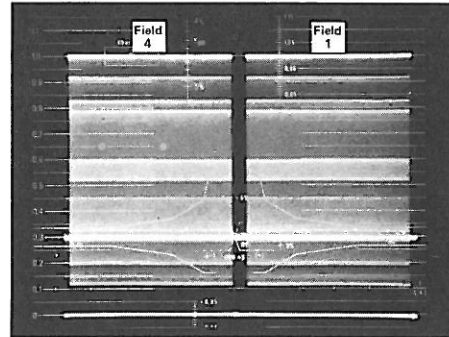

Figure 2.

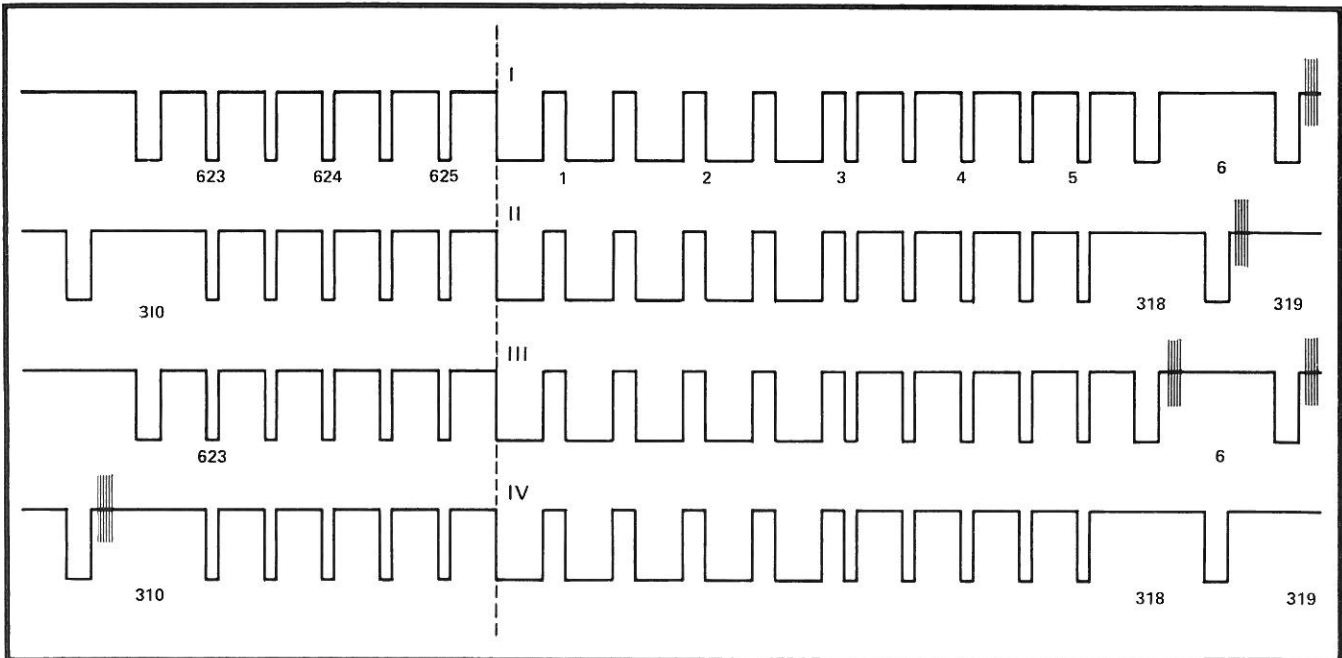

Figure 1.

Application Notes—1480-Series (SN B060000-up)

Verification Procedure

1. Set the DISPLAY switch to 2 FIELD.
2. Depress FIELD 1 and 3 pushbuttons simultaneously.
3. Depress 15 LINES.
4. Adjust VAR LINE SELECTOR to place the intensified portion of the display on the interval between the two fields.
5. Turn the MAG switch to X50.
6. Adjust the HORIZONTAL POSITION to place the interval at mid-screen. Reduce the INTENSITY until the brightened interval is obvious. Readjust the VAR LINE SELECTOR as necessary to display the interval and at least 2 lines on either side of the interval.
7. Check for a burst on either side of the interval with a discernable flicker rate (caused by a reduced repetition rate) indicating the presence of the blanking sequence. Even if the sequence appears to be in error proceed to Step 8, where each field is investigated individually, so that the fault can be located.
8. Depress the FIELD 4 pushbutton. Check the display against that in Figure 4 and use Table 1 to determine if burst is occurring on the correct lines. Follow the remainder of Table 1 using Figure 5 as a reference to check out the entire Bruch blanking sequence.

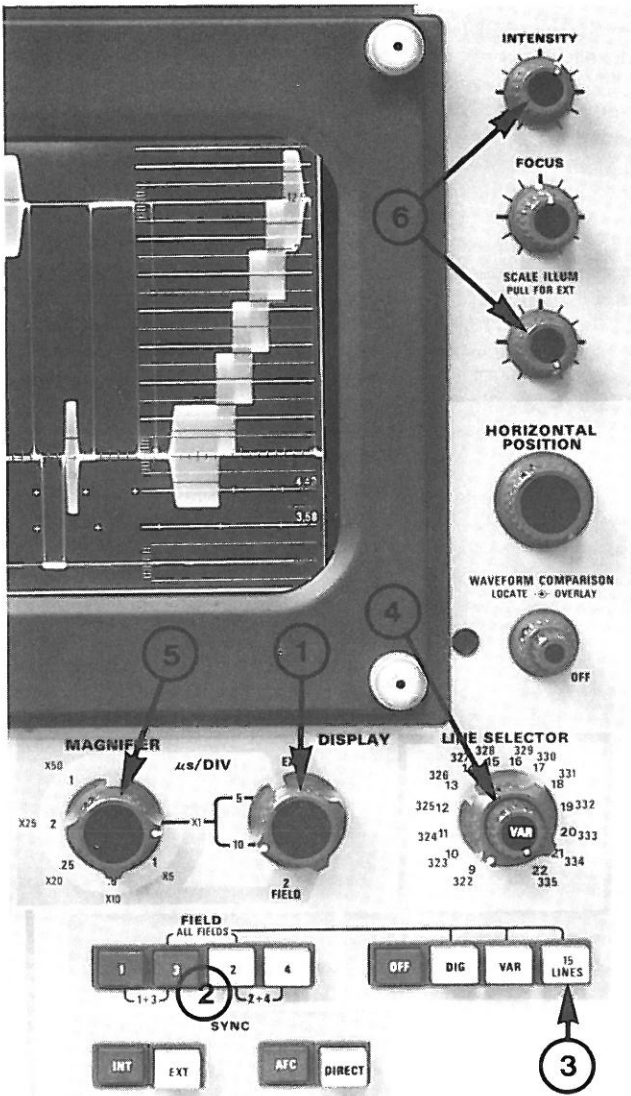

Figure 3.

Figure 3 shows the location of the switches and controls used in the following procedure. The numbers associated with the controls correspond to the step in the procedure in which that control is used.

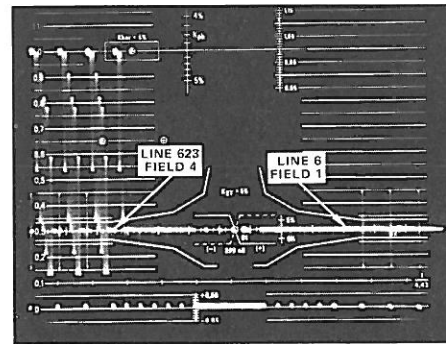

Figure 4.

Application Notes—1480-Series (SN B060000-up)

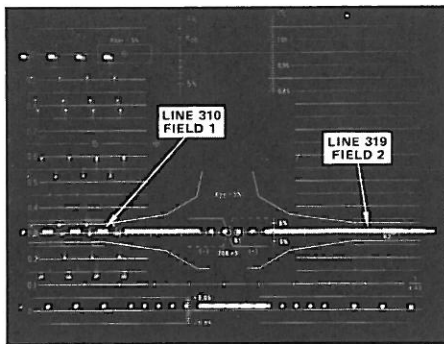

Figure 5a.

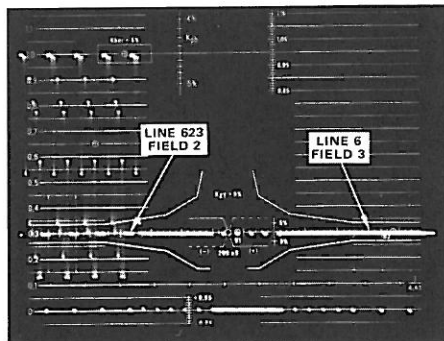

Figure 5b.

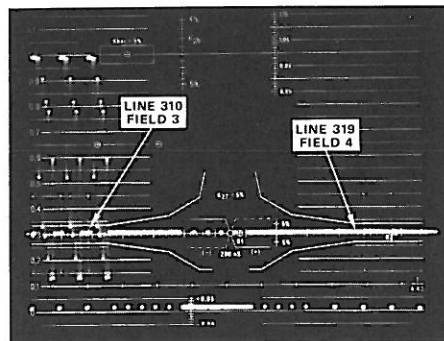

Figure 5c.

The switching used to check the Bruch blanking sequence can also be used to check burst phasing. A minor operational change to a TEKTRONIX 520-Series Vectorscope (521-521A for 625/50 PAL or 522-522A for 525/60 PAL-M) provides an accurately phased display of the burst on selected line for a particular field. Shift the lead that is on pin BO of the Sweep Circuit Board to pin BQ and lift the lead from pin BR. Connect the 1480-Series Waveform Monitor LINE STROBE OUT to the Vectorscope Z-AXIS INPUT and loop-thru connect the video signal to one of the Vectorscope signal inputs. Set the Vectorscope display to FULL FIELD. Set the 1480-Series Waveform Monitor's LINE SELECTOR to 17/330 and depress the DIG pushbutton. The Vectorscope is now displaying the phase of the burst for the selected lines as switched by the 1480-Series Waveform Monitor's FIELD selection pushbuttons. Burst phase is as follows: Field 1 — 135°, Field 2 — 225°, Field 3 — 225° and Field 4 — 135°.

This Application Note has taken advantage of two of the 1480-Series Waveform Monitor's display features, accurate field selection and the 15-line display (used to intensify the displayed vertical intervals). In addition the LINE STROBE OUT was used, along with the field switching, to control the display on a Vectorscope for a quick look at burst phasing.

Table 1

Field Selector	Field	Line Number		Burst	
		PAL	(PAL-M)	PAL	(PAL-M)
4	4	623	(522)	No	(Yes)
	1	6	(8)	No	(No)
1	1	310	(259)	No	(Yes)
	2	319	(270)	Yes	(No)
2	2	623*	(522)	No	(No)
	3	6	(8)	Yes	(Yes)
3	3	310	(259)	Yes	(No)
	4	319	(270)	No	(Yes)

* No burst on either line 622 or line 623 of field 2.

Copyright © 1977, Tektronix, Inc. All rights reserved. Printed in U.S.A. Foreign and U.S.A. Products of Tektronix, Inc. are covered by Foreign and U.S.A. Patents and/or Patents Pending. Information in this publication supersedes all previously published material. Specification and price change privileges reserved. TEKTRONIX, TEK, SCOPE-MOBILE, TELEQUIPMENT, and  are registered trademarks of Tektronix, Inc., P.O. Box 500, Beaverton, Oregon 97077, Phone: (Area Code 503) 644-0161, TWX: 910-467-8708, Cable: TEKTRONIX. More than 50 Subsidiaries/Distributors around the world.

SCALE FACTOR—INPUT A and B 1.0 Volts Full Screen ± 3 mV, 0.5 Volts Full Screen ± 15 mV, 0.2 V/F Screen ± 6 mV.

Ratio: INPUT A to INPUT B 1, ± 0.002 , to 1, AUX VIDEO IN to INPUT A 1.5 ± 0.3 dB.

GAIN—INPUT A to AUX VIDEO OUT 1, ± 0.005 , INPUT A to PIX MONITOR OUT 1, ± 0.02 .

VARIABLE VOLTS FULL SCALE RANGE—Input signals between 0.7 volts and 2.0 volts can be adjusted to 1 volt equivalent display height.

Maximum Input Signal—for inspecification operation of AUX VIDEO OUT and PIX OUT. AC CPL'D: INPUT A and B 2.0 V P-P at any APL—Display distortion: 1.0 V P-P at any APL if both AUX VIDEO OUT and PIX OUT are terminated for distortion-free signal at those outputs. DC CPL'D: INPUT A and B ± 1.5 V, DC \pm Peak AC, AUX VIDEO IN ± 1.5 V, DC \pm Peak AC.

Maximum Output DC Voltage, AUX VIDEO OUT and PIX MONITOR OUT into 75 Ω — ± 0.5 V DC. Common Mode Rejection Ratio (A-B)—60 Hz ≥ 46 dB, 15 kHz ≥ 46 dB, 4.43 MHz ≥ 34 dB.

Frequency Response—FLAT including: INPUT A or INPUT B Through AUX VIDEO OUT or PIX MONITOR OUT from 50 kHz Reference: 50 kHz to 5 MHz $\pm 0.5\%$, 5 MHz to 10 MHz $\pm 0.5\%$, -3% . IRE: Conforms to IRE 1958 standard 23S-1. Attenuation at 4.43 MHz, ≥ 22 dB. LOW PASS: Attenuation ≥ 14 dB, 500 kHz and above. 3.58 MHz $\pm 1\%$ of FLAT at 3.58 MHz. 3 dB down at 3.1 to 3.4 MHz and 3.8 to 4.0 MHz. 4.43 MHz $\pm 1\%$ of FLAT at 4.43 MHz, 3 dB down at 3.9 to 4.1 MHz and 4.7 to 4.9 MHz. DIFF'D STEPS: Permits amplitude comparisons of risers on stair-step signal with automatic gain increase of 5 times, attenuation ≤ 2 dB from 0.4 to 0.5 MHz, attenuation ≥ 20 dB at 15 kHz and 2 MHz, attenuation ≥ 40 dB at 3.58 MHz and 4.43 MHz.

Linear Waveform Distortion—Pulse Preshoot, Pulse Overshoot, and Pulse Ringing $\leq 0.5\%$ of applied pulse amplitude. 25 μ s Bar Tilt $\leq 0.5\%$. Field Square Wave Tilt $\leq 1\%$, Pulse to Bar Ratio 0.99:1 to 1.01:1 or 0.99 to 1.01:1.

Non-Linear Waveform Distortion—Differential Gain Displayed $\leq 0.5\%$ at any APL, AUX VIDEO OUT and PIX MONITOR OUT $\leq 0.25\%$ at any APL. Differential Phase—AUX VIDEO OUT and PIX MONITOR OUT ≤ 0.25 at any APL.

DC RESTORER—Mains Hum Attenuation, Slow $\leq 10\%$. Fast ≥ 26 dB. Shift caused by Presence or Absence of Burst ≤ 1 IRE or 7 mV.

Return Loss (With 75 Ω Termination)—INPUT A or B ≥ 40 dB, DC to 5 MHz, AUX VIDEO IN, AUX Video OUT, or PIX MONITOR OUT ≥ 34 dB, DC to 5 MHz.

Vertical Overscan—for 1 V Peak-to-Peak Composite Video Signal all specifications are valid at 1.0, 0.5, and 0.2 volts FULL SCALE, and any vertical position setting to 5 MHz.

Calibrator Accuracy—1 V $\pm 0.2\%$, 714 mV and 700 mV $\pm 0.5\%$.

Timebase Accuracy and Linearity—5 μ s/DIV and 10 μ s/DIV Accuracy Over Center 10 Div $\pm 1\%$, Linearity Overall $\pm 1\%$.

Magnified Timing and Linearity—For center 10 divisions of unmagnified sweep: $\pm 2\%$ accuracy, $\pm 2\%$ linearity.

2 FIELD Sweep Length and Linearity—12.7 div, ± 0.5 div.

FIELD SELECTOR—Positive selection of ODD (2 & 4) or EVEN (1 & 3) in 525/60 Systems Display starts on selected field. Positive selection of 1, 2, 3, or 4, or 1 & 3, 2 & 4, in 625/50 Systems Display starts on selected field.

LINE SELECTOR—VARIABLE Range: From approximately line 20 of the selected field to approximately line 8 of the next complementary field (example, line 20 or field 1, to line 8 of field 3). Lines intensified by the strobe in 2 FIELD display are the lines displayed in 5 μ s/DIV or 10 μ s/DIV. DIGITAL: Selects line 9/322 to line 22/335. 15 LINE: Identical to VARIABLE, except that 15 successive lines are displayed. ALL FIELDS: Time overlay of all fields any setting of the DISPLAY switch.

Sync Input Requirements—INT 200 mV peak-to-peak to 2 V peak-to-peak composite video. EXT 400 mV peak-to-peak to 2 V peak-to-peak composite video, 200 mV peak-to-peak to 8 V peak-to-peak composite sync. Return loss ≥ 46 dB down to 5 MHz.

Maximum Jitter with 1 V Peak-to-Peak Composite Video + (-26) dB White Noise—Direct 250 ns, AFC 90 ns.

Maximum Jitter with Missing Horizontal Sync Pulses— ≤ 15 ns/missing sync pulse (maximum of 10 consecutive horizontal sync pulses missing).

50 Hz/60 Hz Recognition—Automatically recognizes 50 Hz or 60 Hz scan in dual standard instrument.

Horizontal Trigger—AFC: Horiz. Frequency 15,750 ± 200 Hz, Lock-In Time ≤ 1 sec. Maximum Jitter with Respect to Input Sync 10 ns—Input composite Video or Composite Sync from a 140-series Generator, 12 ns—Variable APL, 12 ns—Variable APL & 4 V rms Hum, 30 ns—Variable APL & 4 V rms Hum + (-36) dB White Noise. Jitter Reduction with Respect to White Noise ≥ 8 dB.

DIRECT—Horiz. Frequency Range ≤ 20 kHz. Maximum Jitter with Respect to Input Sync 12 ns—input Composite Video or Composite Sync from a 140-series Generator, 20 ns—Variable APL, 20 ns—Variable APL & 4 V rms Hum, 90 ns—Variable APL & 4 V Hum $\pm (-36)$ dB White Noise.

EXTERNAL HORIZ IN—Sensitivity 0.5 V/div, Linearity $\pm 1\%$.

RGB/YRGB J9036—RGB Sweep Length Internally selected for $\frac{1}{2}$ normal sweep. YRGB Sweep Length internally selected for $\frac{1}{4}$ normal sweep.

WAVEFORM COMPARISON—LOCATE: Range sufficient to place LOCATE indication any place on 5 μ s/DIV, or unmagnified 10 μ s/DIV sweeps. OVERLAY: Range sufficient to overlay any selected portion of 5 μ s/DIV or unmagnified 10 μ s/DIV on any other portion.

LINE STROBE OUT—Strobe output of line or lines selected by VARIABLE, 15 LINE, or DIGITAL line selector modes and the DISPLAY switch. TTL-amplitude, ac-coupled. Time Constant = 1 μ F, 10 k Ω .

OPTION 1

10X Probe Channel—Scale Factor adjustable to 1 V peak-to-peak equivalent display height, GAIN Range $\pm 10\%$. Gain to AUX VIDEO: Unity, $\pm 3\%$, with gain adjusted for 1 V peak-to-peak equivalent display height. Tilt $\pm 5\%$ on 50 Hz square wave, High Frequency Response $\pm 1\%$, 25 Hz to 5 MHz $\pm 3\%$, 5 MHz to 10 MHz. Referenced to 50 kHz. Differential Phase ≤ 0.25 at any APL. Differential Gain $\leq 0.25\%$ at any APL. Input Resistance 1 M Ω , $\pm 2\%$, not including probe. Input RC Product 20 μ s, $\pm 0.5\%$, not including probe. BNC connector accepts most TEKTRONIX probes. P6065A probe recommended.

10X Probe Calibrator—Output Voltage 1.000 V ± 0.005 V or 0.995 to 1.005 V.

OPTION 4

TAPE T.W. SYNC Input—NTSC: Syncs to either a standard negative-going composite sync pulse of 3.5 V to 4.5 V in amplitude, or a 240 Hz negative-going tape recorder pulse, 1.5 V to 4.5 V in amplitude, 2.083 ms in width, and 4.166 ms in period. PAL: Syncs to negative-going 200 Hz tape recorder pulse, 1.5 to 4.5 V in amplitude 2.5 ms in width, and 5 ms in period.

Mains Voltage—Ranges: 100 VAC, 110 VAC, 120 VAC, 200 VAC, 220 VAC, 240 VAC $\pm 10\%$. Frequency: 48 Hz to 62 Hz, Max Power Consumption 75 W.

OPERATING TEMPERATURE—0 C to 50 C.

Dimensions and Weights

1480 C Series		
Height	8.25 in	21 cm
Width	8.50 in	21.6 cm
Depth	16.95 in	43.0 cm
Net Weight	21.5 lb	9.81 kg
Domestic shipping weight	≈ 28.5 lb	≈ 12.9 kg
Export-packed weight	≈ 41.5 lb	≈ 18.8 kg

Two 1480 C Series Waveform Monitors can be mounted side-by-side, or one mounted alongside an associated picture monitor in a standard 19-inch rack or console.

1480 R Series		
Height	5.25 in	13.3 cm
Width	19.0 in	48.2 cm
Rack Depth	18.0 in	45.7 cm
Net Weight	24.6 lb	11.2 kg
Domestic shipping weight	≈ 53.1 lb	≈ 24.1 kg
Export-packed weight	≈ 75.1 lb	≈ 34.1 kg

Instrument fits standard 19-inch rack.

ORDERING INFORMATION

- 1480C NTSC Waveform Monitor
- 1480R NTSC Waveform Monitor
- 1481C PAL Waveform Monitor
- 1481R PAL Waveform Monitor
- 1482C PAL M Waveform Monitor
- 1482R PAL M Waveform Monitor
- 1485C PAL/NTSC Dual Standard Waveform Monitor
- 1485R PAL/NTSC Dual Standard Waveform Monitor

- Option 1 1 megohm, 20 pf probe input (probe not included)
 - Suggested Probe
 - P6065A 10X Probe, 6-ft. Order 010-6065-13
 - 9-ft. Order 010-6105-05
- Option 2 With carrying Case (Cabinet Version Only)
- Option 3 With Blank CRT

TEKTRONIX Automatic Correction Products are also available for 525/60 NTSC systems.



P.O. Box 500, Beaverton, Oregon 97077 U.S.A.

application notes



TEKTRONIX®

committed to
technical excellence



no. 17

The Auxiliary Video Facility of the 1480-Series of Waveform Monitors.

by L.E. Weaver

Tektronix European TV Engineering Consultant

The AUXILIARY VIDEO facility of the 1480-Series of Waveform Monitors is a novel and imaginative feature, whose inclusion indicates the care taken during the planning of these instruments to ensure the greatest flexibility of use, combined with ease of operation and a degree of protection against obsolescence.

Its primary function is to make possible a wide range of signal processing facilities in a side chain, which can be switched in or out without impairing the normal use of the instrument. As can be seen from the schematic diagram (Figure 1), the AUX VIDEO path is functionally an alternative to the built-in range of networks available by the use of the RESPONSE control, but with the advantage of being isolated from the normal signal path by means of buffer amplifiers. It is provided with precision 75Ω input and output terminations, and an overall gain of 1.5 dB. This means that 75Ω passive networks can be inserted without fear of reflection effects, and that gain is available to compensate for their basic loss. The calibration will then be correct whichever path is in use.

The advantages of this facility are illustrated by the following examples.

Noise Reduction by Band Limitation

It is not always realised that the random noise associated with a video signal often possesses a bandwidth extending surprisingly far above the nominal upper limit of the video band. This comes about because the video signal spectrum is limited by aperture and other effects, whereas the equipment handling it is commonly made to have a wide bandwidth to minimise distortion.

In such instances, it follows that the signal-to-noise ratio can be improved at the cost of only a small signal impairment by limiting the bandwidth to its nominal value by means of a delay-compensated lowpass filter of suitable design. This is especially effective with signals which have been transmitted over long microwave links where the noise spectrum tends to rise with increasing frequency, and the greater part of the noise power lies at the higher frequencies.

An example of this is given in the photographs of Figures 2a and 2b, where the spectrum of the random noise was quasi-triangular. In Figure 2a it is not really possible to be sure how much distortion exists at the base of the 2T pulse, whereas in Figure 2b where the signal has previously been passed through an FL4/557 lowpass filter of BBC design connected between AUX VIDEO OUT and AUX VIDEO IN, it is clear that one would proceed with a measurement with much more confidence. The improvement is even greater subjectively than appears from the photographs.

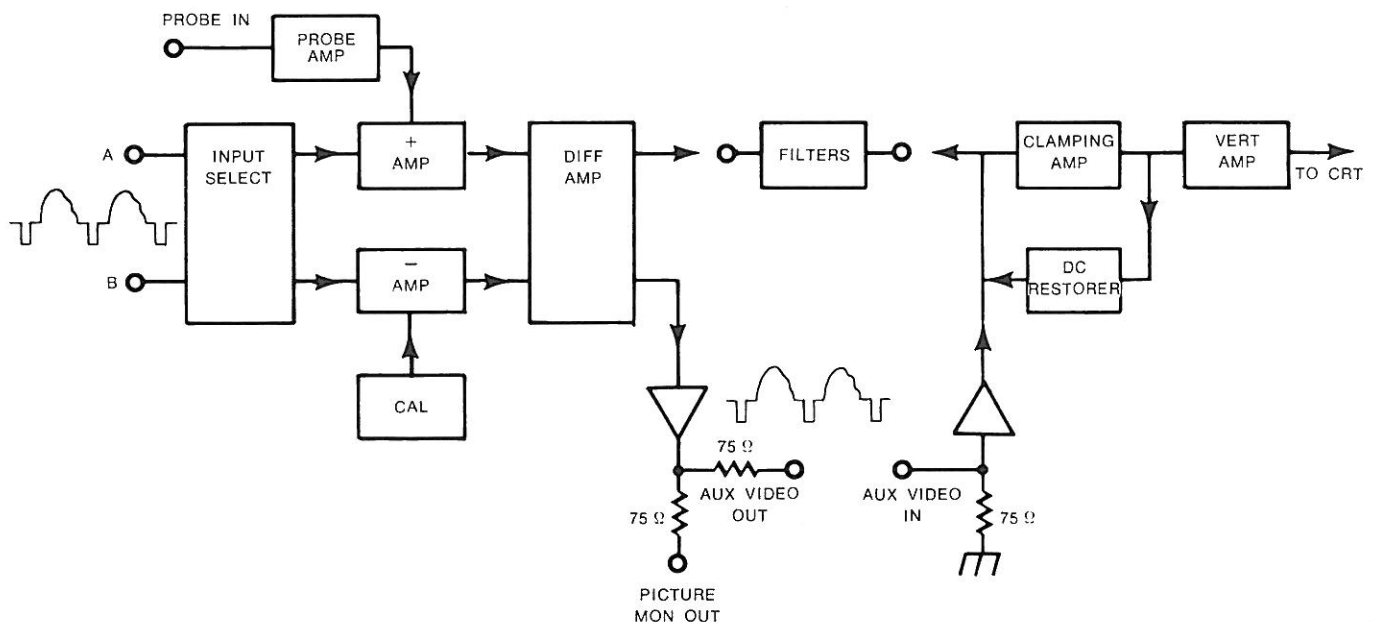

Figure 1. Block Schematic of Auxiliary Video Facility.

Application Notes—1480-Series (SN B060000-up)

It is also possible to make use of the VIDEO OUT facility to drive another instrument simultaneously from the same signal. For instance, a vectorscope can be added when required without disturbing the normal utilisation of the waveform monitor.

Operational Networks

Tektronix has incorporated into the 1480-Series the widest practicable range of operational networks, that is chrominance and luminance separating filters, and so on. However, it is obviously not possible to anticipate all user requirements, and in fact it may well happen that these needs will change with time. The AUX VIDEO path provides the ability to add or to modify networks as the situation demands, thus ensuring a great deal of flexibility and a degree of protection against obsolescence.

Equaliser Design

Coaxial cable possesses a loss characteristic giving a steadily increasing attenuation with frequency, so in order to maintain the distortion at an acceptably low level it is necessary to equalise long cable runs. It will be shown that the AUX VIDEO facility can be utilised as a very simple and efficient means of designing these networks.

There are two approaches to video equaliser design. In the first, one measures the response to be equalised and then calculates the element values of the network best fitting the inverse of this response over the video band. In the second, advantage is taken of the fact that highly standardised TV test waveforms are now readily available, to obtain the equaliser values directly by inserting in series with the cable a variable network which is then adjusted until the output waveform is judged to have a sufficiently low degree of distortion. This latter method is very fast and economical, since the result is obtained immediately and without computation. It also has the great advantage that the effect of any small residual errors in the fit of the equaliser is automatically minimised, a benefit which could only be achieved by the first method with the aid of a complicated computer program.

Principle of Variable Corrector

In general one would like to employ constant-resistance networks for equalization purposes since these may be inserted into a circuit of the same impedance without mismatch, and one is sure of obtaining the planned overall response. Unfortunately, even in their simplest forms they are quite complicated networks to make variable since in every instance a pair of arms has to be changed simultaneously so as to maintain the constant-resistance property.

However, there is an extremely useful, and largely neglected, simple relationship between the arms of a constant-resistance equaliser and the two-terminal network which, when inserted between a pair of equal resistances, gives the same insertion-loss characteristic.¹ This should be clear from the diagram (Figure 3).

Now the AUX VIDEO circuit in the 1480-Series provides just the requisite condition for the use of a two-terminal network as an equaliser, that is a pair of output and input impedances which are pure 75Ω resistances. It therefore becomes possible to construct a two-terminal network from variable resistors, capacitors and inductors which is capable of providing a very large range of loss characteristics when inserted in the AUX VIDEO path. Any one of these can then be converted immediately into the corresponding constant-resistance equaliser by a simple numerical process.

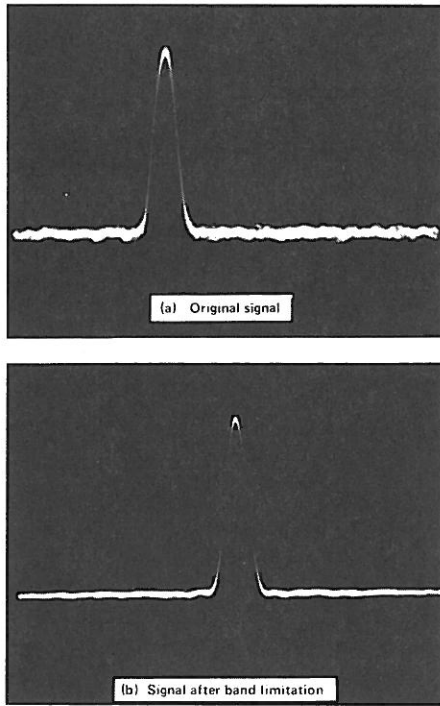

Figure 2. Improvement in Signal-To-Noise Ratio by Band Limitation.

The advantages of connecting the filter in the AUX VIDEO path are that it may be left in place as long as desired, ready to be called up at the turn of a switch, and that the distortion likely to be caused by connecting this type of filter between long coaxial cable lengths in a loop-through circuit is eliminated by the good 75Ω terminations provided by the AUX VIDEO path. Moreover, lowpass filters of this type have a considerable time delay, in this instance 500 ns, as can be seen by comparing Figures 2a and 2b. Any possibility of timing errors from such a delay in one signal path only is completely avoided by inserting the filter in the AUX VIDEO circuit.

Most usually, the basic loss of the filter is less than the 1.5 dB gain provided in the AUX VIDEO channel. It is then preferable to insert an attenuator pad of the correct value in series with the filter so as to make the AUX VIDEO gain unity while at the same time preserving the 75Ω circuit impedance. This will ensure that the calibration of the waveform monitor remains the same in both conditions of use. Details of suitable types of pad are given in Appendix I.

Insertion of Measuring Equipment

Video measuring equipment whose output requires a waveform monitor display can be inserted in series with the AUX VIDEO path whenever desired without breaking the input video feed. A case in point is described in some detail in Application Note ≈ 12 , Part 4, where a TEKTRONIX 1478 Calibrated Chrominance Level Corrector is employed for the measurement of chrominance-luminance gain and delay inequalities. With this kind of connection it becomes possible to make measurements freely under in-service conditions with no fear that the use of the equipment will modify the video signal and become obvious to the viewer. For the same reason, the measuring equipment may be removed or interchanged without any effect on the video feed.

Application Notes—1480-Series (SN B060000-up)

It might be mentioned that this is a very practical and efficient procedure which has been used professionally, in the U.K. for example, for the routine equalisation of coaxial cable circuits, and special equipment has been designed for the purpose.

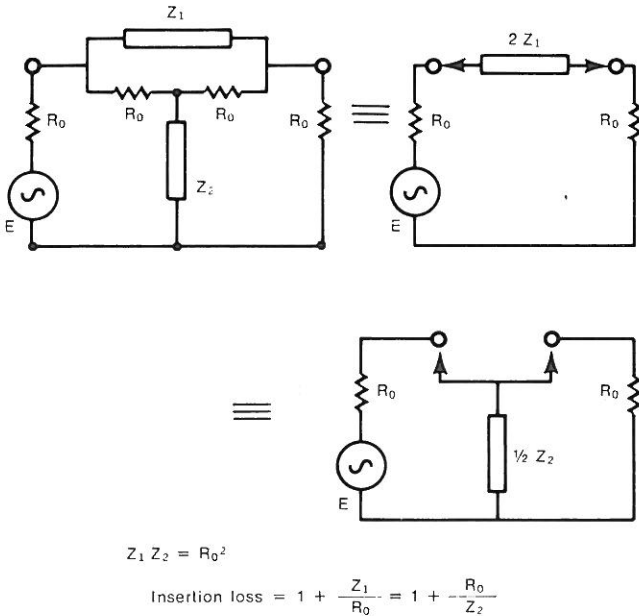

Figure 3. Equivalence between Constant-Resistance Equaliser and 2-Terminal Networks in Series and Shunt Insertion.

Illustration of Design Procedure

Great care is taken with the 1480-Series to make sure that the gain is exactly the same in both the luminance and chrominance regions. However, when the monitor is installed the actual point at which the video signal is switched to its input is often physically separated from the input connector by an appreciable length of coaxial cable. It follows that the waveform monitor will have in effect a chrominance-luminance gain inequality which may be completely overlooked, and all chrominance amplitude measurements will be in error by that amount.

For instance, a typical high-quality flexible coaxial cable such as RG 59/U has a loss at 4.43 MHz of about 0.75 dB per 100 feet. Now as a result of the constraints of bay wiring it is very easy to have 20 feet or more of such cable between the waveform monitor input connector and a switching matrix, say in round numbers a chrominance-luminance gain inequality of 0.2 dB at the least. This is a significant error which should not be tolerated. The answer is to insert a simple constant-resistance equaliser in series with the input video feed.

The design procedure is as follows. The simplest equaliser configuration likely to give the required characteristic will always be chosen first. In this instance it will consist of a resistor and a capacitor in parallel for the series arm, as in Figure 4.

The next step is to select a value for the basic loss, that is the loss at zero frequency, which must obviously always be somewhat larger than the required subcarrier boost. For the sake of example this will be taken to be 1.5 dB, which is given in series insertion by a resistance of 28.3Ω. In most cases it is found easier to switch capacitors than inductors, so the series insertion form is preferred. This resistor is then connected between AUX VIDEO OUT and AUX VIDEO IN, and arrangements

made to switch capacitors across it as required. The values for various subcarrier boosts are shown in Table I, for both 3.58 MHz and 4.43 MHz.

A video test signal generator providing a good sine-squared pulse and bar signal, such as the TEKTRONIX 148 for example, is then connected to the point where the video signal is normally applied, and a suitable display of the chrominance pulse (20T, 12.5T or 10T) obtained on the waveform monitor. Initially, with a resistor alone in the series arm, the baseline of the pulse will appear concave, but as the capacitance is increased from zero, this decreases until a point is reached where the baseline is as flat as in the input pulse. Multiplying this critical value by two gives the series arm capacitance of the constant-resistance equaliser.

The element values for the final equaliser can be calculated or taken from Table I. With these small values of correction its construction presents no real difficulties. The required capacitance can be synthesised by connecting values in parallel, and the inductance value can often be found to a sufficient accuracy in a series of commercial miniature wire-ended chokes.

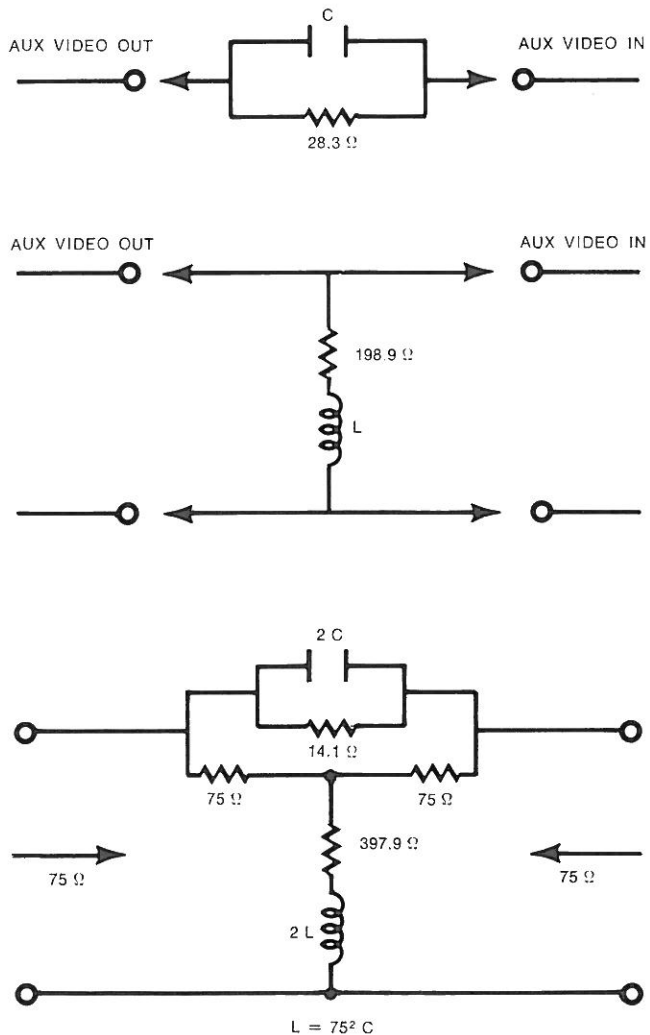

Figure 4. Conversion of 2-Terminal Networks to the Equivalent Constant-Resistance Equaliser.

The final step is to connect the equaliser in series with the waveform monitor and to readjust the gain to normal, since there will now be a loss of 1.5 dB in the circuit. This will present no problem if the monitor is used with a 75Ω termination since the loss can be made good simply by recalibrating the instrument with the preset variable gain control on the front panel, but with a loop-through connection it will become necessary to insert an amplifier. In this case, where video gain amplifiers are available to standard values such as 3 dB or 6 dB it will be most convenient to choose this value as the basic equaliser loss.

Table I
Values of 2C and 2L as a Function of Subcarrier Boost

Boost(dB)	3.58 MHz		4.43 MHz	
	2C(nF)	2L(μH)	2C(nF)	2L(μH)
0.1	0.91	5.1	0.74	4.2
0.2	1.34	7.6	1.08	6.1
0.3	1.71	9.6	1.38	7.8
0.4	2.06	11.6	1.67	9.4
0.5	2.42	13.6	1.96	11.0
0.6	2.79	15.7	2.26	12.7
0.7	3.20	18.0	2.59	14.6
0.8	3.67	20.6	2.96	16.7
0.9	4.20	23.6	3.39	19.1
1.0	4.85	27.3	3.92	22.1

Longer cable lengths can be equalised by exactly the same procedure, with the exception that the very simple configuration employed above will have to be replaced by a more complex structure. The one recommended does not in fact follow the desired law of attenuation particularly well, but where the loss at subcarrier frequency is no more than, say, 1 dB, the errors are negligibly small and any greater complexity of the equaliser arm is not justified by any improvement in performance. Details of networks suitable for cable equalisation in general can be found in suitable texts^{1,2}.

Impedance Transformation

The AUX VIDEO connector provides an output with a 75Ω source impedance and the same polarity as the output for any of the inputs to the waveform monitor. In particular, it may be used in conjunction with the X 10 probe as an impedance transformer between a very high and a 75Ω impedance. This is invaluable when one wishes to drive another instrument with a 75Ω input impedance, from a probe, for instance a TEKTRONIX vector-scope.

Conclusions

The examples given above are typical of the uses to which the AUX VIDEO facility can be put, and clearly demonstrate the potential it possesses for increasing the field of utilisation of the 1480-Series of Waveform Monitors. It is hoped they will suggest further ideas for employing this facility in the solution of operational and other problems.

References

- 1: Bode: Network Analysis and Feedback Amplifier Design, D. Van Nostrand 1945.
- 2: Landee, Davis and Albrecht: Electronic Designer's Handbook, McGraw Hill, 1952.

Appendix 1
Resistance Values for 75Ω Attenuator Pads

dB Loss	R ₁ (Ω)	R ₂ (Ω)	R ₃ (Ω)	R ₄ (Ω)	R ₅ (Ω)	R ₆ (Ω)
0.1	0.43	6.51k	0.86	13.0k	0.86	6.48k
0.2	0.86	3.26k	1.73	6.51k	1.71	3.22k
0.3	1.30	2.17k	2.59	4.34k	2.55	2.13k
0.4	1.73	1.63k	3.46	3.26k	3.38	1.59k
0.5	2.16	1.30k	4.32	2.61k	4.20	1.27k
0.6	2.59	1.08k	5.18	2.17k	5.01	1.05k
0.7	3.02	929	6.05	1.86k	5.81	894
0.8	3.45	813	6.92	1.63k	6.60	777
0.9	3.88	722	7.79	1.45k	7.38	687
1.0	4.31	650	8.65	1.30k	8.16	615
1.1	4.74	591	9.52	1.19k	8.92	556
1.2	5.17	541	10.39	1.09k	9.68	506
1.3	5.60	499	11.27	1.00k	10.46	465
1.4	6.03	463	12.14	932	11.16	429
1.5	6.46	432	13.02	871	11.90	398

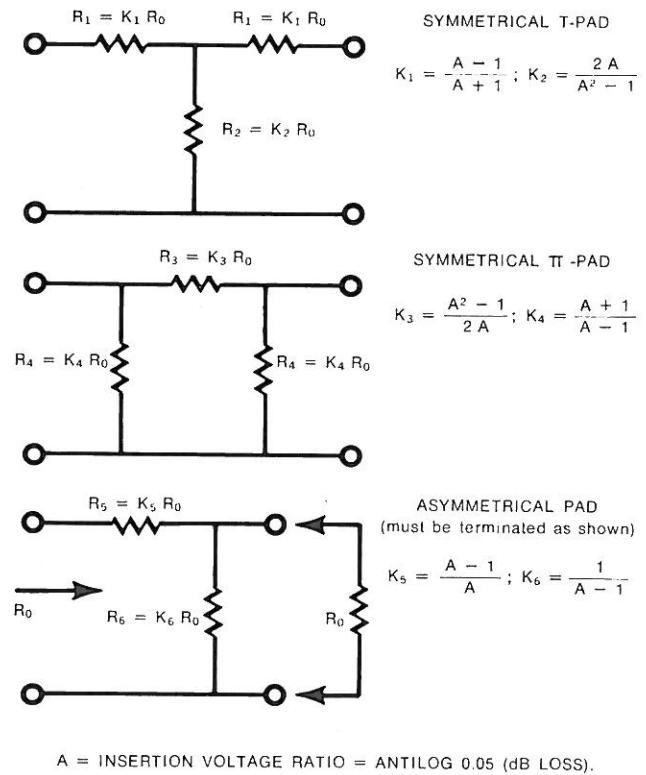



Figure 5. Design of Attenuator Pads.

Copyright © 1974, Tektronix, Inc. All rights reserved. Printed in U.S.A. Foreign and U.S.A. Products of Tektronix, Inc. are covered by Foreign and U.S.A. Patents and/or Patents Pending. Information in this publication supersedes all previously published material. Specification and price change privileges reserved. TEKTRONIX, SCOPE-MOBILE, TELEQUIPMENT, and  are registered trademarks of Tektronix, Inc., P. O. Box 500, Beaverton, Oregon 97005, Phone: (Area Code 503) 644-0161, Telex: 36-0485, Cable: TEKTRONIX. Overseas Distributors in over 40 Countries.



A NEW NTSC GRATICULE FOR THE 1480 WAVEFORM MONITOR

(Operational Measurements Using a New NTSC Composite Graticule)
By Charles W. Rhodes and John Lauer

The modern display features of the TEKTRONIX 1480 Waveform Monitor have been further enhanced by a new, versatile NTSC graticule. Many linear transmission distortion measurements that have been difficult or inconvenient can now be made with relative ease. The uncluttered scale design and well thought out organization of this new graticule yield consistently accurate results with a minimum of control setting changes.

Graticule A

Vertical Scales. The vertical scale of this new NTSC composite graticule extends from -50 to $+120$ IRE Units in 10 IRE Unit increments. In addition, three separate 2 IRE Units/div scales are provided at strategic locations for rapid, precise measurements of key signal parameters. A dashed line at 7.5 IRE Units, or 7.5%, is provided for use as a black level setup reference.

The right-side scale, for measuring transmitter % of modulation, extends from 0%, at the $+120$ IRE Unit line, to 100%, at the -40 IRE Unit line. The 0 (zero) IRE Unit reference line, which contains horizontal divisions, is subdivided for measurement of time.

Horizontal Scales. The horizontal reference line at 0 IRE Units is 12.7 divisions long. Using the $5 \mu\text{s}/\text{DIV}$ time base, the time base line is $63.5 \mu\text{sec}$ (1H) long. The $10 \mu\text{s}/\text{DIV}$ time base provides a time base of $127 \mu\text{sec}$ (2H). This makes it possible to calibrate the 5 and $10 \mu\text{s}/\text{DIV}$ time bases using the TV signal.

The -30 IRE Unit line contains nine

divisions, which correspond to one-half of the period of a cycle of NTSC burst at $100 \text{ nsec}/\text{div}$. At $200 \text{ nsec}/\text{div}$, the divisions or "tick marks" equal the period of one cycle of burst. These relationships make it possible to accurately calibrate the 100 and $200 \text{ nsec}/\text{div}$ time bases, using the convenient NTSC color burst.

Also located on the 0 IRE Unit horizontal reference line are points T and B. Point T is for use in measuring rise and fall-time. It lies directly below point R and denotes the time zero when the 90% point of a 100-IRE Unit rising transient, or 10% of a 100-IRE Unit falling transient, intersects point R (at the 80-IRE Unit line).

If there is any serious tilt of the blanking level, there is ambiguity in the setting of the blanking level to the 0 IRE reference level. To remove that ambiguity, a study group of the CCIR (CMTT/187-E) has recommended that insertion gain be measured between the center of the white bar and a blanking level reference point. On Graticule A, this blanking level reference point is labeled B.

Internal and External Graticules. Two graticules are installed in each 1480. Selective illumination of either graticule allows the user to, in effect, choose the appropriate graticule for his measurement.

Parallax errors are entirely avoided when an internal graticule is used. The external graticule, however, is subject to parallax error. This error can be eliminated, when taking waveform photographs, by using an external graticule designed to correct for parallax. Tektronix provides such graticules and strongly recommends them for waveform photography. Labeled Photographic, they should only be used for waveform photography because they are designed to compensate for about 3% parallax error. Using an external graticule (same scale size as the internal graticule) for visual monitoring will provide a parallax

error of 1% or less. Visual (unmarked) graticules should not be used for waveform photography.

Using Graticule A

The primary test signal in this application note is an NTSC composite test signal, generally a Vertical Interval Test Signal (VITS). The composite test signal can be either the one required by the FCC (§73.669) for remote transmitter control or the CCIR composite VITS for international program exchange (CCIR Recommendation 473, Annex II, 525-line systems, adopted 1974).

While the graticule special scales provide 2% resolution increments at 1.0 VOLTS FULL SCALE, greater resolution is provided by the 1480 Waveform Monitor's calibrated vertical expansion. A 1.0 volt video signal can be expanded 2X or 5X without loss of accuracy, providing direct resolution of up to 0.2% for some of the measurements that follow.

Calibration Checks. Time base calibration accuracy can be checked with just the video signal. The 5 and $10 \mu\text{s}/\text{DIV}$ time bases are checked by measuring the time duration of 1 or 2 lines ($63.5 \mu\text{sec}$ or $127 \mu\text{sec}$). The 0.1 and $0.2 \mu\text{s}/\text{DIV}$ time bases are checked by measuring burst period against the scale (tick marks) on the -30 IRE Unit line.

Vertical gain, which may be reset from the front panel, is easily checked by using the 1480's built-in calibrator. Television Application Note 11, "The Measurement of Signal Level With the 1480-Series of Waveform Monitors," by L. E. Weaver, discusses an extremely accurate method of setting vertical gain.

Insertion Gain

In all measurements using television test signals, whether full field or VITS, signal level or insertion gain must be checked first. The vertical sensitivity of the 1480 should first be checked, 1.0 V equals 140 IRE.

Use the $5 \mu\text{s}/\text{DIV}$ time base to display

Risetime and Falltime

Graticule A has built-in rise and fall time measurement capability. Point R at 80 IRE Units aligns with T on the 0 IRE Unit reference line. See Figure 11.

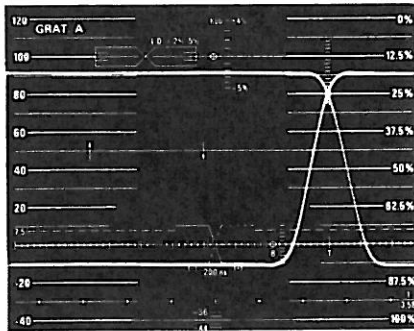

Figure 11. Double exposure showing the measurement of rise and fall times of a T step, T_r and $T_f = 120\text{nsec}$.

To measure rise or fall time, set the transition amplitude to 100 IRE Units (use the VARIable VOLTS FULL SCALE). Vertically position the display so that the transition is from the -10 IRE Unit line to the +90 IRE Unit line. Use the 100 nsec/div time base and horizontally position the rise (or fall) of the transition through point R on the short 2 IRE Unit/div scale. Measure the distance from point T on the 0 IRE Unit reference line to where the transition crosses the reference line. Time/div is 100 nsec; the T step transitions shown in Figure 11 have a rise and fall time of 125 nsec.

In a linear system, risetime and falltime of the bar signal are equal. Non-linearities may affect risetime and falltime unequally. Measuring both by the above method detects such non-linear effects.

Bar Trail or Smear

Bar trail occurs after a transition from white to black. It is discussed in some detail in CMTT Document/189E; however, it need only be discussed here as the picture impairment appearing as streaking, following white-to-black transitions. To measure bar trail, use the 100 nsec/div time base. Position the trailing edge of a 100-IRE Units step transition (0-100 IRE Units on graticule) through the descending arrow (at the 50 IRE Unit line intersection) and measure displacement on the + and -10 IRE scale just to the right of point B. This scale is properly located for 525/60 standards.

Figure 12 shows the bar trail measurement using the white-to-blanking level transition of the staircase. A transition of 250 nsec falltime must be used because faster falltime (1T) may display ringing,

which would confuse the measurement.

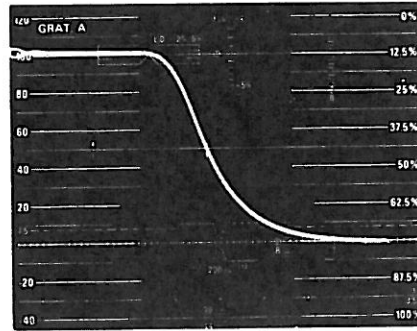

Figure 12. The Bar Trail measurement, Bar Trail = 5%.

The remote transmitter control composite VIT Signal (FCC §73.669) has 250 nsec step transitions for the white bar and the falling transition of the bar may be used.

Measuring Half-Amplitude Duration of a Pulse

Adjust the VARIable VOLTS FULL SCALE for a pulse amplitude of 100 IRE Units. Shift the pulse down until the peak is at the 50 IRE Unit line. See Figure 13. The Graticule 0 IRE Unit reference line now intersects the pulse at the half-amplitude point.

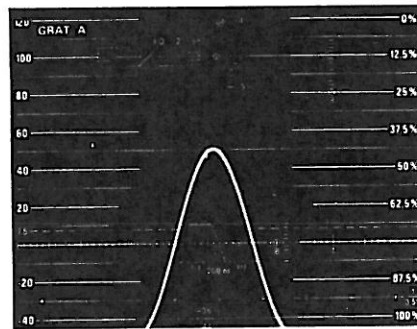

Figure 13. Half-amplitude Duration (H.A.D.) measurement of a 2T pulse, H.A.D. = 245nsec.

By selecting the proper time base, the half-amplitude duration (HAD) of the pulse is directly measured on the 0 IRE Unit reference line. Use a 100 nsec/div time base for a T or 2T pulse, and a 500 nsec/div time base for a 12.5T modulated sine-squared pulse.

Sync Amplitude

Sync amplitude error can be read directly, using the scale at the center of the -40 IRE Unit graticule line. This scale is marked at -36, -38, -40, -42, and -44 Units, or -10%, -5%, 0%, +5%, and +10%, respectively. It is located in time so that it can be used with either the 10 $\mu\text{s}/\text{DIV}$ or 2 FIELD

DISPLAY with equal accuracy.

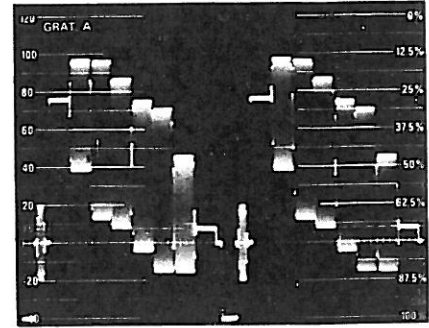

Figure 14a. Horizontal (line) Sync Amplitude measurement, Sync Amplitude = 40 IRE.

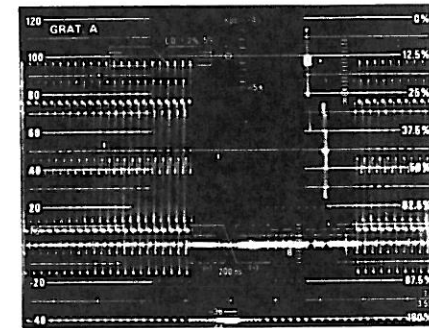

Figure 14b. Vertical (field) Sync Amplitude measurement, Sync Amplitude = 40 IRE.

Vertically place the blanking level of the composite video waveform on the graticule's 0 IRE Unit reference line. Check insertion gain and then read horizontal sync amplitude using the 10 $\mu\text{s}/\text{DIV}$ time base (Figure 14a), or vertical sync amplitude using the 2 FIELD DISPLAY (Figure 14b).

Tests With Other Signals

Amplitude Versus Frequency Response.

A simple technique for checking frequency responses uses the multiburst signal to check for amplitude variations at the different frequencies. See Figures 15a and 15b. Care must be used in interpreting results of measurements made with the multiburst signal because it is not uncommon to note harmonic distortion on one or more of the bursts.

Even-order harmonics cause inequality between positive and negative peaks. Therefore, if the amplitude of only one of the peaks is measured, incorrect results will be obtained. Measure both the pedestal to positive peak and pedestal to negative peak to determine if even-order harmonic distortion is present.

Odd-order harmonic distortions affect

Application Notes—1480-Series (SN B060000-up)

both peaks in the same manner, causing the peak-to-peak amplitude to be either too high or too low. The peak-to-peak amplitude depends on whether the 3rd harmonic can pass through the system. High frequency phase shift of this 3rd-order harmonic will cause the peak-to-peak amplitude of the burst to be distorted.

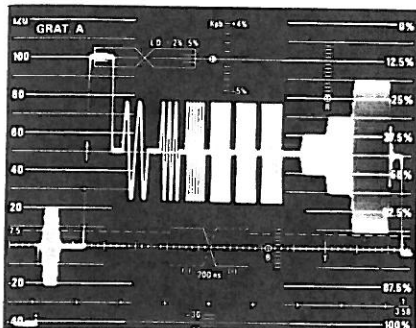

Figure 15a. Combination of Multiburst and Modulated Pedestal signals.

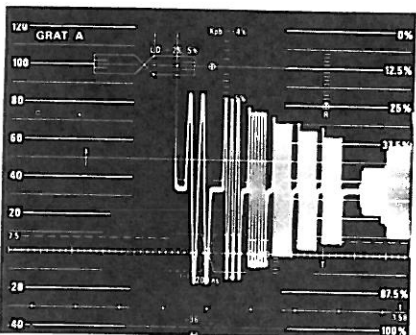

Figure 15b. Amplitude/Frequency Response 3 dB down at 3 Mhz.

The multiburst signal shown in Figures 15a and 15b is the combined multiburst and modulated pedestal signal also described in CCIR Recommendation 473, Annex II. Vertically position the multiburst signal blanking level to the 0 IRE Unit reference line and use the VARIABLE VOLTS FULL SCALE to adjust for a white flag amplitude of 100 IRE Units. Set the 1480 VOLTS FULL SCALE to 0.5 (burst amplitude equals 100). Check for equal amplitude of the multiburst packets above and below the pedestal (even-order harmonic distortion). To measure the frequency response, successively position the negative peak of each multiburst packet to the 0 IRE Unit reference line and measure the peak positive amplitude of the packet.

Color Bar Chrominance Amplitude

The chrominance amplitude of 75% amplitude color bars can be rapidly checked on the new graticule using the

R scale. There are only three chrominance amplitudes present in the six color bars: 62, 82, and 88 IRE Units. See Figure 16.

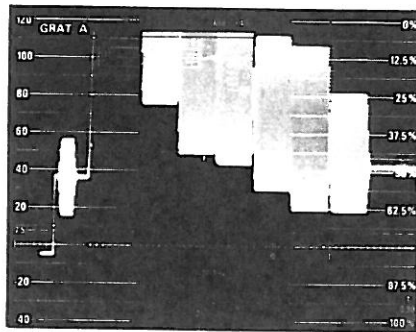

Figure 16. Measuring Color Bar Chrominance Amplitude of the red and blue color bars, Amplitude = 88 and 62 IRE respectively.

To measure each color bar amplitude, place the negative peak of the bar on the 20 IRE Unit graticule line, below the R scale. The displayed peak amplitudes become 82, 102, and 108 IRE Units respectively for the 62, 82, and 88 IRE-Unit-amplitude color bars.

Using Burst for Waveform Monitor

Timing Check. Timing accuracy can be quickly verified by comparing the duration of burst cycles against the timing scale on the -30 IRE Unit graticule line. See Figure 17.

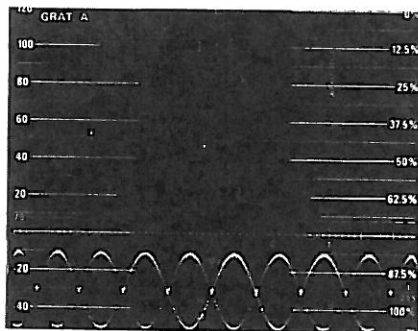



Figure 17. Time Base Accuracy check at 100 ns/division sweep rate.

Use either a 100 or 200 nsec time base and check for duration of each cycle of burst. This is a very accurate method to verify or calibrate (see 1480-Series Waveform Monitor Instruction Manual) the 1480 time base without special test equipment.

The discussion of test methods in this application note points out that proper design of the graticules for waveform monitors promotes versatility and accuracy. The new Graticule A used with the 1480 Waveform Monitor, provides

great versatility and accuracy without clutter—a feature operating personnel will appreciate. Some early 1480-Series Waveform Monitors (including 1485 Dual Standard models) may not be equipped with this graticule. If you desire an external version of this graticule, contact your nearest TEKTRONIX field office or representative for assistance.



Copyright © 1975, Tektronix, Inc. All rights reserved. Printed in U.S.A. Foreign and U.S.A. Products of Tektronix, Inc. are covered by Foreign and U.S.A. Patents and/or Patents Pending. Information in this publication supersedes all previously published material. Specification and price change privileges reserved. TEKTRONIX, SCOPE-MOBILE, TELEQUIPMENT, and  are registered trademarks of Tektronix, Inc., P. O. Box 500, Beaverton, Oregon 97077, Phone: (Area Code 503) 644-0161, TWX: 910-467-8708, Cable: TEKTRONIX. Overseas Distributors in over 40 Countries.

12/75

AX-3264



USING THE 1480-SERIES WAVEFORM MONITOR

television application note no.21

All Fields Display to Improve NTSC

In-Service Testing

by John Lauer

Since their introduction, the use of Vertical Interval Test Signals for in-service measurements has revolutionized television transmission system measurement techniques. For the first time it became possible to comprehensively assess distortions caused by the transmission system while the system was in use. To further these techniques a feature that permits, for example, the simultaneous display of VITS occurring on all fields has been incorporated in the 1480-Series Waveform Monitor. In instruments of this series designed for use on PAL, where four pushbuttons uniquely select the four fields of the PAL signal, a separate pushbutton-selected function labeled ALL FIELDS is provided. Instruments designed for NTSC, on the other hand, will have two field-selection pushbuttons and when both are depressed the display is selected. This new display mode presents three distinct advantages:

1. Simultaneous viewing of VITS.
2. Transmission system analysis through comparison of VITS inserted at separate points.
3. A novel in-service field time distortion measurement technique.

Other useful applications of this new and versatile feature may be developed to go along with the demands of ever more sophisticated measurements.

Simultaneous Viewing of VITS

With the TEKTRONIX 1480-Series Waveform Monitor's All Fields display mode, the Vertical Interval Reference Signal (VIRS), two or four VITS, or a combination of both VITS and VIRS on both fields can be viewed simultaneously. The Display and Magnifier switches determine how many vertical interval lines are displayed.

To display one line from each field start by setting the DISPLAY switch to $5 \mu\text{s}/\text{DIV}$ to provide a single tv line (1H) display. Activate the line selection by depressing the DIG (digital) pushbutton and set the LINE SELECTOR for the desired line. Then to obtain the All Fields display, push in both FIELD selection pushbuttons. (For PAL equipped instruments depress the ALL FIELDS pushbutton, located in the lower right corner of the front panel).

Setting the DISPLAY switch to $10 \mu\text{s}/\text{DIV}$ provides two successive lines (2H) from each field. The line selected by the LINE SELECTOR setting and the one following it are displayed. See Figure 1.

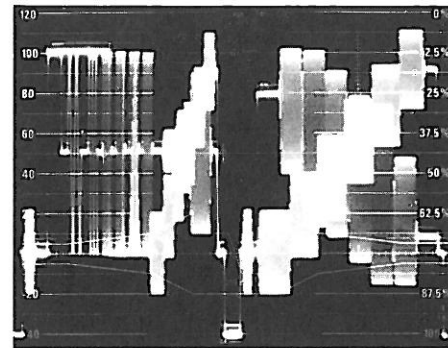

Figure 1. Two VITS lines from each field.

A novel way to display all signals inserted on lines 17 through 20 of both fields is to set the DISPLAY switch to 2 FIELD and set the MAG to X50. Depress both of the FIELD selection pushbuttons (or in the case of PAL instruments, push in the ALL FIELDS pushbutton) and horizontally position the start of the trace onto the screen. Note that the VITS (and VIRS) are displayed only at the start of the sweep when 2 fields are displayed in the All Fields mode. Figure 2 shows the display of line 17 and 18 VITS plus the VIRS on line 19.

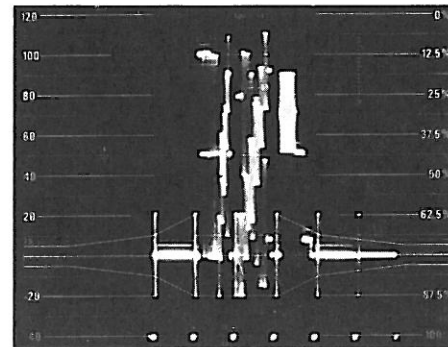

Figure 2. Lines 17, 18, (VITS) and 19 (VIRS) from each field.

Comparative Distribution System Analysis

It is relatively easy to assess the distortion of an entire distribution system by using, for example, K-rating of the VITS added at the point of origin. However, this does not localize individual problems in the system. While not new, the idea of inserting test signals at different points in the system and comparing them takes on a new dimension when the test signal can be directly overlaid for comparison rather than make tedious measurements with the graticule. The All Fields display mode, makes it possible to overlay the same line in both fields in order to compare waveform distortions which have occurred over the entire system and those which arose in only a portion of the system.

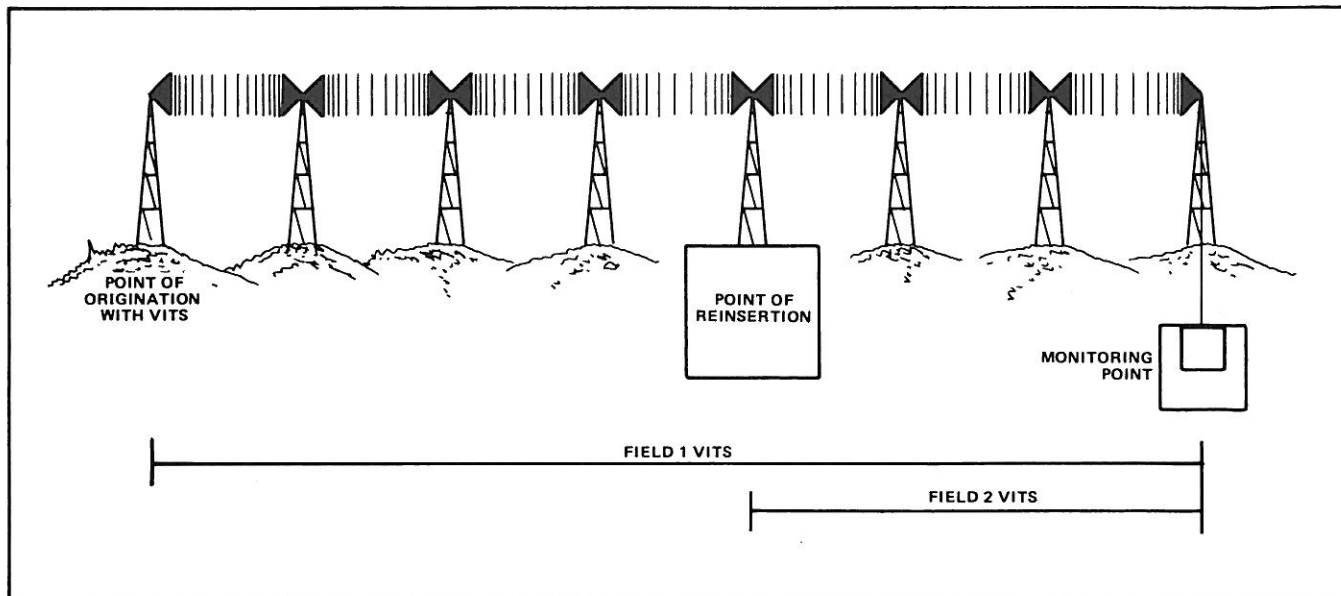

Figure 3. VITS insertion for distribution system analysis.

This display mode opens up an interesting test method for distribution system analysis. All that is required, in addition to the display, is a method to insert on the same line of the opposite field, the identical test signal. Precautions must be taken that the outputs of any test signal generators used for this purpose are as closely matched as current technology permits, including the adjustment of VITS timing relative to sync. The TEKTRONIX 149/149A NTSC Test Signal Generator has a front panel adjustment labeled INSERT DELAY, that is adjusted, in this case, for coincidence of both VIT Signals. This matching of generators is an excellent use of the 1480-Series All Fields display, with one generator inserting on one field and the other inserting on the opposite field.

For purpose of examination, the composite test signal specified by the CCIR¹, for international exchange of program material, is substituted on field 2 line 17 for the VITS normally inserted on that line. To further simplify this illustration the field 1 VITS will traverse the entire system, while field 2 VITS are, for this purpose being reinserted at some downstream point.

The technique is universal in that the size of the system under test can be anywhere from a studio-to-transmitter link to a transcontinental network. By locating the 1480-Series Waveform Monitor downstream from the reinsertion point, three distinct pieces of information are readily available:

1. Overall system distortion.
2. Distortion occurring between original insertion point and reinsertion point.
3. Distortion occurring between the reinsertion point and the monitoring point.

The overall system distortion is easily assessed from the K-rating of the line 17 field 1 composite test signal that has traversed the entire system and will show the total amount of distortion throughout the system. The K-rating of the line 17 field 2 composite signal provides a measure of the distortion occurring between the reinsertion point and the monitoring point. When both fields are overlaid, display, the difference in the signals is the measure of the distortion occurring between the origination and the reinsertion point.

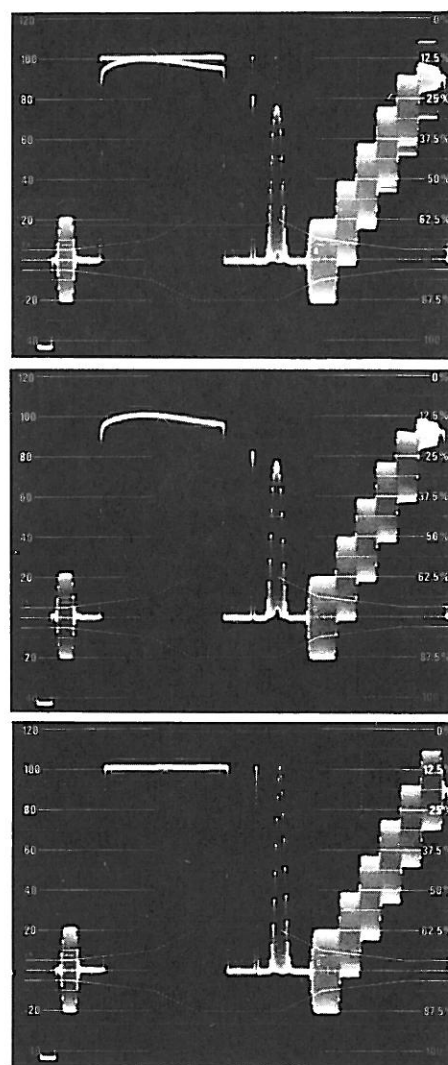

Figure 4. VITS comparison: a. Line 17 VITS from both fields.
b. Line 17 VITS from field one.
c. Line 17 VITS from field two.

¹CCIR Recommendation 473, Annex 2 (525 line systems) adopted 1974.

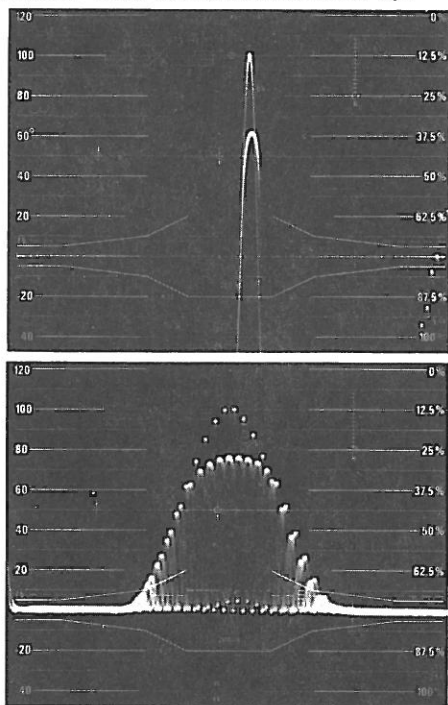

Figure 5. a. Comparison of 2T pulses from both fields (0.2 Volts Full Scale).
 b. Comparison of 12.5T pulses from both fields.

VIR Signal Comparison

Another use of the All Fields display mode allows the comparison of in-house generated VIRS (which may be used as a reference waveform once it has been determined that the locally generated VIRS is within tolerance) to the incoming program line VIRS. Set the in-house VIRS inserter to strip and reinsert on one field only. Set the 1480-Series Waveform Monitor LINE SELECTOR to line 19 and depress both FIELD selection pushbuttons (or the ALL FIELDS pushbutton on PAL equipped instruments) for VIRS comparison. This comparison is not intended for diagnostic purposes, but rather to help alert an operator to a potential problem or to allow him to adjust signal parameters. The program video should not be subjected to this deletion of the program related VIRS or the reinsertion of a locally generated VIR Signal. This comparison technique should only be done on a monitoring circuit and not on the program line itself.

Observing Field Time Distortion

It has not been practical, until now, to make in-service field time distortion (tilt) measurements. With the All Fields display mode of the 1480-Series Waveform Monitor it can be done with relative ease.

The accuracy of this measurement will be somewhat less than the current white bar test method used in full field, but this is to be expected since much less energy will be contained in a VIT Signal. Figure 6 shows field time distortion measured with a white bar.

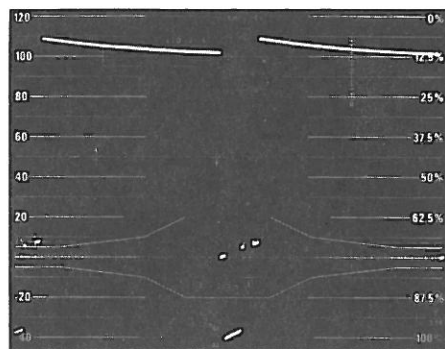

Figure 6. Field Time Distortion observed with a 100 IRE Flat Field signal.

This observation technique requires deleting the VIT Signal from a selected line in one field, while maintaining a VIT Signal of maximum energy content on the same line in the opposite field. The result will be a displayed difference in level in subsequent lines due to field time distortion. It may be considered as the residue of energy from the VIT Signal due to tilt. The signal used for Figure 7a is from the noise pedestal generated by a 147/147A when full line deletion at a 100 IRE level is selected. Figure 7b shows the same measurement with the Composite waveform which, it must be noted, is less sensitive.

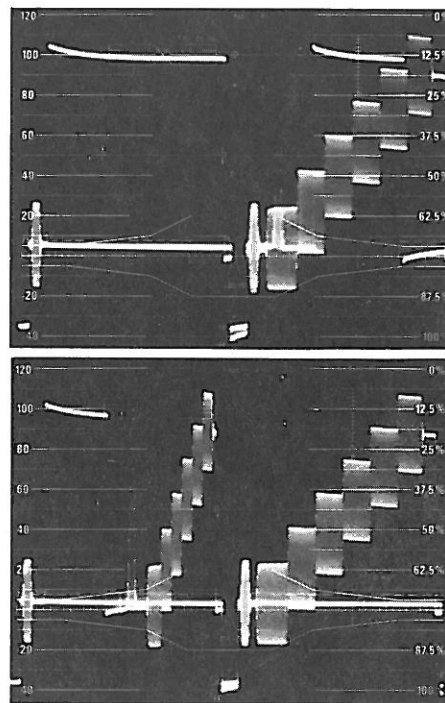
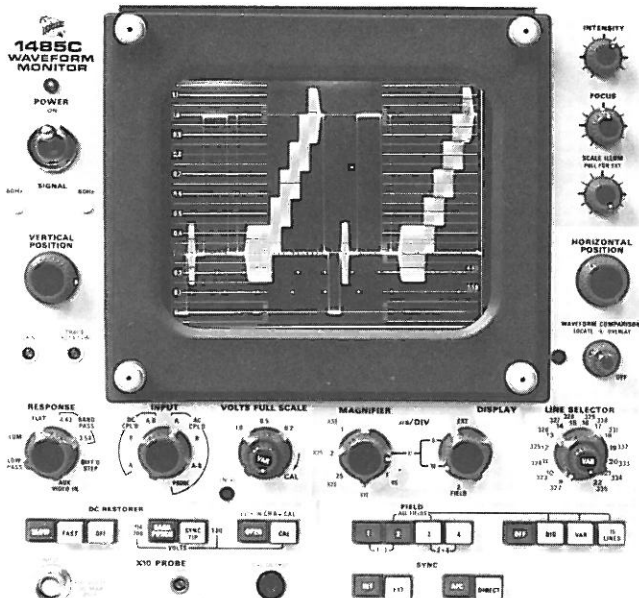

Figure 7. Field Time Distortion observed from VIT Signals
 a. A full line 100 IRE pedestal from a 147/147A.
 b. A Composite Test Signal.

This technique is obviously less sensitive, but will display enough field time distortion (field time tilt) to be a useful in-service measurement technique.

The versatile TEKTRONIX 1480-Series Waveform Monitor is ideally suited for routine operating, signal analysis or laboratory investigations. This application note deals with only one display mode, All Fields, for further application information contact the nearest Tektronix Field Office or representative.



1485C

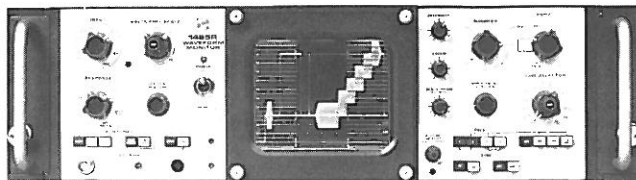

1485R

ORDERING INFORMATION

- 1480C NTSC Waveform Monitor
- 1480R NTSC Waveform Monitor
- 1481C PAL Waveform Monitor
- 1481R PAL Waveform Monitor
- 1482C PAL-M Waveform Monitor
- 1482R PAL-M Waveform Monitor
- 1485C PAL/NTSC Dual Standard Waveform Monitor
- 1485R PAL/NTSC Dual Standard Waveform Monitor

Option 01 1 megohm, 20 pf probe input (probe not included)

Suggested Probe
P6105A 10X Probe, 6-ft, Order 010-6065-13
 9-ft, Order 010-6105-05

Option 02 With Carrying Case (Cabinet Version Only)

Option 03 With Blank CRT

Option 07 Slow Sweep

Option 08 Adds capability of recognizing four field sequence of SECAM (1481C, 1481R, 1485C, 1485R only)

OPTIONAL ACCESSORIES

Mounting Cradles—A cradle assembly, with associated bezel, allows the 1480C Waveform Monitor to be mounted alongside a 9-inch Conrac Picture Monitor in a standard 19-inch rack. A cradle and bezel are also available for mounting two 1480C's side-by-side.

For mounting 9-inch SNA-9 Picture Monitor (Requires 8¾ inches rack space)

- Cradle Assembly 014-0020-00
- Bezel, for mounting 1480C on operator's left 014-0023-00
- Bezel, for mounting 1480C on operator's right 014-0024-00

For mounting two 1480C Waveform Monitors side-by-side (requires 8¾ inches rack space)

- Cradle Assembly 014-0020-00
- Bezel 014-0022-00

1480R Cradle Assembly—For mounting the 1480R in a WECO backless rack, Order 426-0309-00

CHARACTERISTICS

VERTICAL DEFLECTION

Inputs—Input A and B are 75 Ω high impedance loop-through. Return loss is ≥40 dB from Dc to 5 MHz in a 75 Ω system. Aux Video Input is internally terminated in 75 Ω. Return loss is ≥34 dB from Dc to 5 MHz.

Scale Factor—A and B input calibrated—1.0, 0.5, 0.2 volts full scale. Variable—Range for each scale factor at least +40% to -50%. Aux Video Input 1.5 dB gain.

Max. Input Voltage—2 volts peak-to-peak (Ac coupled).

Frequency Response—Flat—Flat to 5 MHz ±0.5%; 5 MHz to 10 MHz +0.5%, -5%. Low Pass—Attenuation ≥14 dB, 500 kHz and above. 3.58 MHz Band Pass—Amplitude within ±1% of amplitude in Flat response position. Bandpass approximately 600 kHz. 4.43 MHz Band Pass—Amplitude within ±1% of amplitude in Flat response position. Bandpass approximately 600 kHz. IRE—Conforms to IRE Standard 23S-1 1958 amended.

DC Restorer—Keyed type, may be turned off. Clamping point: BACK PORCH/SYNC TIP. TIME CONSTANT: FAST reduces mains hum ≥26 dB, SLOW reduces mains hum <1 dB.

Calibrator—Amplitude selected by dc Restorer switch. Sync Tip — 1 volt ±0.2%, Back Porch — 714 mV or 700 mV ±0.5%.

Linear Waveform Distortion—Pulse/bar ratio ±1%. SHORT TIME: preshoot, overshoot, ringing ≤0.5% on 100 ns sin² pulse. LINE TIME: TILT or rounding ≤0.5%. FIELD TIME: (AC coupled) ≤1%.

Non-Linear Distortion—Differential gain ≤0.5%.

HORIZONTAL DEFLECTION

Time-Base—5 μsec and 10 μsec/Div, ±1% over center 10 divisions. 1 μsec, 0.5 μsec, 0.25 μsec, 0.2 μsec and 0.1 μsec/Div ±2% over center 10 divisions. 2 FIELD — 12.7 division ±1%.

External Sync Input—Two loop-through high impedance, with ≥46 dB return loss in a 75 Ω system. Inputs are slaved to A and B input or to A external sync input only.

External Sync Input Requirements—400 mV to 2 volts composite video or 200 mV to 8 volts composite sync.

Field Selector—Positive selection of Field 1 or 2 in the NTSC system. Positive selection of 1, 2, 3, 4 or 1 & 3, 2 & 4 in the PAL systems.

Line Selector—Dig—Selects lines 9 to 22 NTSC, 9/322 to line 22/335 PAL, line 9/272 to line 18/285 PAL-M. VAR—Approximately line 20 of the selected field to line 8 of the next related field. 15

lines—Identical to VAR, except 15 successive lines are displayed.

Sync—AFC: Horizontal frequency range is 15.75 kHz ±200 Hz. Max. jitter with respect to input sync 10 ns (30 ns with 4 volts rms hum plus -36 dB white noise). Direct: Horizontal frequency ≤20 kHz. Max. jitter with respect to input sync 12 ns (90 ns with 4 volts rms hum plus -36 dB white noise).

OUTPUTS

Line Strobe—TTL amplitude pulse. Pulse coincident with line or lines selected by VAR, 15 LINE or DIG modes of DISPLAY switch.

Picture Monitor—Output of incoming video with LINE STROBE added. Output impedance is 75 Ω. Output adjusted to unity with respect to A and B video input.

Aux Video—Output of incoming video. 75 Ω output impedance. Gain adjustable to unity with respect to A and B video input.

OTHER CHARACTERISTICS

RGB/YRGB Staircase Input—Approx. 12 volts for 12.7 divisions deflection. RGB sweep length internally selected for 1/3 normal sweep. YRGB sweep length internally selected for 1/4 normal sweep length.

Mains Voltage—Ranges: 100 V ac, 110 V ac, 120 V ac, 200 V ac, 220 V ac, 240 V ac ±10%. Frequency: 48 Hz to 62 Hz, Max Power Consumption 75 W. At factory, 1480 preset for 110 V ac. 1481, 1482, 1485, preset for 220 V ac.

OPTION 1

10X Probe Channel—Scale Factor 1 V, 0.5 V, 0.2 V full screen with 10X attenuator probe. GAIN Range ±10%. Tilt ≤5% on 50 Hz square wave, High Frequency Response ±1%, 25 Hz to 5 MHz. ±3%, 5 MHz to 10 MHz. Referenced to 50 kHz. Input Resistance 1 MΩ, ±2%, not including probe. Input RC Product 20 μs, ±0.5%, not including probe. BNC connector accepts most TEKTRONIX probes. P6065A probe recommended.

10X Probe Calibrator—Output Voltage 1.000 V ±0.005 V or 0.995 to 1.005 V.

Dimensions	Cabinet		Rackmount	
	in	cm	in	cm
Height	8.25	21.0	5.25	13.3
Width	8.50	21.6	19.0	48.2
Depth	16.95	43.0	18.0	45.7
Weight	lb	kg	lb	kg
Net	21.5	9.8	24.6	11.2
Shipping	≈28.5	≈12.9	≈53.1	≈24.1

SPECIFICATION

This section covers the Electrical, Mechanical and Environmental specification of 1480-Series Waveform Monitors. Included here are the Electrical Specifications for Options 1, 4, 5, and 7. Options 2 and 3 require no change in the Electrical Specification and Option 6 has its own supplemental manual.

The electrical characteristics that follow can be verified using the Performance Check Procedure in Section 5.

ELECTRICAL CHARACTERISTICS

The electrical performance requirements given here can only be achieved over an operating ambient-temperature range of 0°C to +50°C, after a warm-up time of 20 minutes (necessary for operating temperatures at or near 0°C). In addition, the Performance Requirements are only valid if the instrument is calibrated in an ambient temperature between +20°C and +30°C, after a minimum warm-up time of 10 minutes.

Performance Requirements

Performance Requirements listed in this section assure accurate instrument performance. Where necessary they are specifically tested by the Performance Check Procedure found in Section 5. In many cases, it is not necessary to check each individual requirement, because assurance may be achieved in other ways.

In some areas, certain levels of performance have been designed into this instrument, and if not present, other broader Performance Requirements will not be met.

In a few cases, the equipment required is extremely expensive, not readily available, or the procedure necessary to verify performance is very exacting. Under these circumstances, lot sampling and repetitive testing is done at the factory to ensure that the instrument will continue to meet these Performance Requirements.

Table 4-1

VERTICAL SYSTEM

Characteristic	Performance Requirement	Supplemental Information
Input Impedance	75 ohms, nominal	Auxiliary Video Input
Vertical Ranges	VOLTS FULL SCALE 1.0 0.5 0.2	Display NTSC CCIR 140 IRE 100% 140 IRE 100% 140 IRE 100%
Vertical Accuracy VOLTS FULL SCALE 1.0 0.5 0.2	±7 mV ±15 mV ±7 mV	Any one range may be adjusted to unity. However, the accuracy of the others may not remain within the Performance Requirement.
Input Gain Ratios A to B	1 to 1 ±0.002 (0.998-1.002)	
AUXiliary VIDEO INput to INPUT A	1.5 dB ±0.3 dB	
INPUT A to AUXiliary VIDEO OUTput	1 to 1 ±0.005 (0.995-1.005)	Adjustable
INPUT A to PIX MONITOR OUTput	1 to 1 ±0.02 (0.98-1.02)	

Table 4-1 (cont)

Characteristic	Performance Requirement	Supplemental Information
Maximum Input Signal Ac coupled INPUT A and B	2.0 V, peak-to-peak at any average picture level 1.0 V, peak-to-peak at any average picture level, with both AUXiliary VIDEO OUTput and PIX MONITOR OUTput terminated.	Maximum dc component, 5V
Dc coupled INPUT A and B and AUXiliary VIDEO INput	± 1.5 V, dc + peak ac	
Maximum voltage from Loop-Thru common terminal to chassis in "Floating Ground" mode	4 Vrms at mains frequency.	
Rejection of common-to-chassis in "Floating Ground" mode	At least 50 dB at mains frequency.	
VARIABLE VOLTS FULL SCALE Gain Range	0.5:1 to 1.4:1	
Common-Mode-Rejection Ration INPUT A—B with 1 V peak-to-peak common mode signal.		
60 Hz	at least 46 dB	
15 kHz	at least 46 dB	
4.43 MHz	at least 34 dB	
Vertical Overscan 1 V peak-to-peak Composite Video Signal	No added signal degradation to 5 MHz.	0.5 and 0.2 Volts Full Scale
5 MHz to 10 MHz	$\pm 3\%$ degradation at two screen heights.	0.5 Volts Full Scale
	$\pm 8\%$ degradation at five screen heights.	0.2 Volts Full Scale
Maximum setting of VARIABLE VOLTS FULL SCALE.		Vertical Performance can be degraded up to 2%

Table 4-1 (cont)

Characteristic	Performance Requirement	Supplemental Information
Frequency Response Flat		INPUT A & B, AUXiliary VIDEO INPUT through AUXiliary VIDEO
50 kHz - 5 MHz	$\pm 2\%$	OUTPUT or Picture (PIX)
5 MHz - 8 MHz	+2%, -3% from 50 kHz reference.	MONITOR OUTPUT (Additive calibrator mode to 5 MHz only.)
8 MHz - 10 MHz	+2%, -5% from 50 kHz reference.	

NOTE

In the Performance Verification, Section 5, and the Adjustment Procedure, Section 8 of this manual, make all checks and adjustments of vertical bandpass to the Specification noted above.

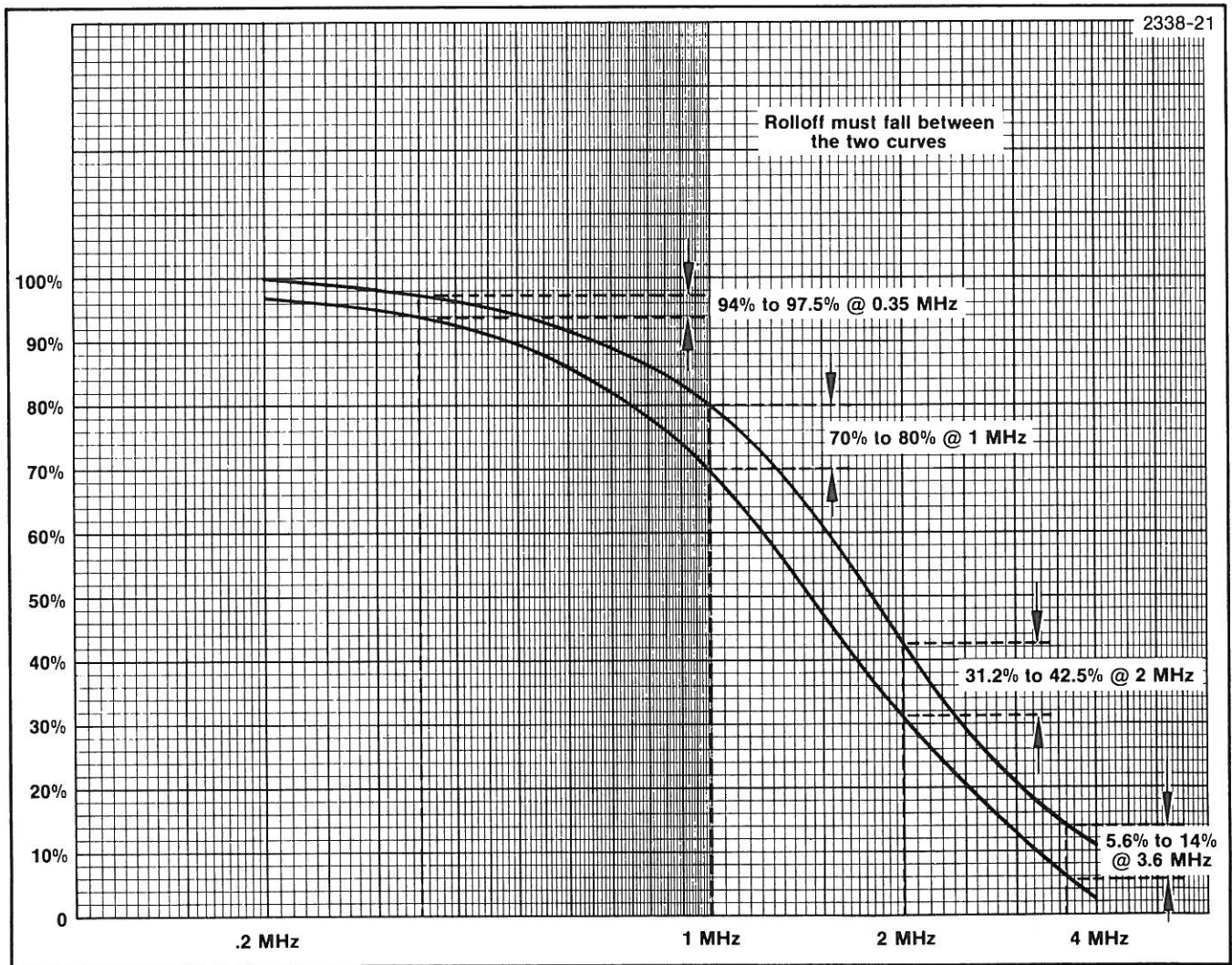

Fig. 4-1. IRE Standard 23S-1, 1958.

Table 4-1 (cont)

Characteristic	Performance Requirement	Supplemental Information
Filters		
IRE	Conforms to IRE Standard 23S-1, 1958, See Figure 4-1. At least 22 dB down at 4.43 MHz.	
Luminance	Less than 3 dB down at 1 MHz. At least 40 dB down at 4.43 MHz.	
Low Pass	At least 14 dB down at 500 kHz and above.	
Bandpass		
3.58 MHz	±1% of flat at 3.58 MHz, -3 dB between 3.1 and 3.4 MHz and 3.8 & 4.0 MHz.	
4.43 MHz	±1% of flat at 4.43 MHz, -3 dB between 3.9 & 4.1 MHz and 4.7 & 4.9 MHz.	
Differentiated Steps (Diff'd Steps)	Less than 2 dB 0.4 MHz to 0.5 MHz. At least 20 dB 14 kHz and 2.0 MHz. At least 40 dB 3.58 MHz and 4.43 MHz.	Vertical gain increase approximately 5 times to compare staircase risers.
Linear Waveform Distortion		
Pulse preshoot, overshoot, and ringing	Less than 0.5% of applied pulse amplitude.	
25 μs bar tilt	Less than 1% of applied pulse amplitude.	
Pulse-to-bar ratio	0.99:1 to 1.01:1	
Field squarewave tilt	Less than 1% of applied squarewave amplitude.	
Non-Linear Waveform Distortion		
Differential gain displayed	Less than 0.5% any APL.	
AUXiliary VIDEO OUTput	Less than 0.25% any APL.	
Picture (PIX) MONITOR OUTput	Less than 0.25% any APL.	
Differential phase		
AUXiliary VIDEO OUTput	Less than 0.25° any APL.	
Picture (PIX) MONITOR	Less than 0.25° any APL.	
Maximum Output DC Voltage		
AUXiliary VIDEO OUTput	±0.5 V dc into 75 ohms	Input signal absent and line strobe present.
Picture (PIX) MONITOR OUTput	±0.5 V dc into 75 ohms	

Table 4-1 (cont)

Characteristic	Performance Requirement	Supplemental Information
DC Restorer		
Mains hum attenuation		Change of back porch or sync tip level caused by hum.
SLOW position	Less than 0.9 dB.	
FAST position	More than 26 dB.	
Shift caused by absence or presence of burst	Less 7 mV (CCIR) or 1 IRE (NTSC)	
Calibrator accuracy		
1.00 V	$\pm 0.2\%$	
0.714 V	$\pm 0.5\%$	NTSC
0.700 V	$\pm 0.5\%$	CCIR
Return Loss		
INPUT A or B (With 75 ohm termination.)	More than 40 dB, dc to 5 MHz.	Any front-panel control setting, instrument on or off.
AUXiliary VIDEO Input	More than 34 dB, dc to 5 MHz.	Instrument on only.
AUXiliary VIDEO OUTput	More than 34 dB, dc to 5 MHz.	Instrument on only.
Picture (PIX) MONITOR OUTput	More than 34 dB, dc to 5 MHz.	Instrument on only.

Table 4-2

**X10 PROBE INPUT
(Option 1)**

Characteristic	Performance Requirement	Supplemental Information
Input Resistance	1 Megohm $\pm 2\%$	Not including probe.
Input RC Product	20 μ s $\pm 0.5\%$	Not including probe.
GAIN Range	$\pm 10\%$	Adjustable for 1 volt peak-to-peak display amplitude.
Gain	Unity $\pm 3\%$ (with GAIN adjusted for equivalent 1 volt peak-to-peak display).	
Frequency Response		Referenced to 50 kHz.
25 Hz to 5 MHz	$\pm 2\%$	
5 MHz to 10 MHz	+3%, -5%	
Tilt	Less than 5% on 50 Hz squarewave.	FAST DC RESTORER eliminates low-frequency tilt on a composite video signal.
Non-Linear Distortion		
differential gain	Less than 0.25%, any APL	
differential phase	Less than 0.25°, any APL	
Probe Calibrator		
waveform	Squarewave	
duty cycle	50%	
period	4 horizontal lines.	
output voltage	1.000 V $\pm 0.5\%$ (0.995 V to 1.005 V)	
output impedance	Approximately 950 ohms	

Table 4-3
SYNCHRONIZATION
(Standard Instruments)

Characteristic	Performance Requirement	Supplemental Information
SYNC Input INTernal	200 mV to 2 V peak-to-peak composite video.	Composite video applied to A or B VIDEO INPUT.
EXTernal composite video	400 mV to 2 V peak-to-peak composite video.	Composite video applied to EXTERNAL SYNC Input.
composite sync	200 mV to 8 V peak-to-peak composite sync.	Composite sync applied to EXTERNAL SYNC Input.
DIRECT SYNC Horizontal Frequency Range	Up to 20 kHz	Frequencies much below 15.75 kHz will not permit a normal TV display.
Sync Jitter with composite video or composite sync	12 ns maximum jitter	With respect to input sync. With up to 4 V rms hum.
with variable APL (10 - 90%)	20 ns maximum jitter	With up to 4 V rms hum.
With variable APL (10 - 90%) + 36 dB white noise	90 ns maximum jitter	With up to 4 V rms hum.
AFC SYNC Horizontal Frequency Range	15.75 kHz \pm 200 Hz	
Lock-In Time	Less than 1 second	
Sync Jitter with composite video or composite sync	10 ns maximum jitter	With respect to input sync. With up to 4 V rms hum.
with variable APL (10 - 90%)	12 ns maximum jitter	With up to 4 V rms hum.
with variable APL (10 - 90%) + 36 dB white noise	30 ns maximum jitter	With up to 4 V rms hum.
Jitter with respect to white noise.		Jitter doubles with each 6 dB increase in white noise.
Noise Immunity DIRECT	Less than 250 ns jitter with 1 V composite video plus -26 dB white noise.	
AFC	Less than 90 ns jitter with 1 V composite video plus -26 dB white noise.	

Table 4-3 (cont)

Characteristic	Performance Requirement	Supplement Information
Jitter from missing line sync-pulses.	Less than 15 ns per missing sync pulse.	Maximum of 10 consecutive line sync-pulses.
50/60 Hz Recognition		Automatic for dual-standard models.
Return Loss	Greater than -46 dB to 5 MHz.	

Table 4-4

SYNCHRONIZATION

(Option 4 & 5)

(Video Tape Recorder Tone Wheel Sync)

Characteristic	Performance Requirement	Supplemental Information
Tape Tone Wheel Sync		All Performance Requirements listed in Table 4-3 apply.
NTSC (525/60)		
pulse polarity	Negative	
repetition rate	240 Hz	
pulse period	4.166 ms	
pulse width	300 μ s	
pulse amplitude	4 V to 15 V	
PAL (625/50)		
pulse polarity	Negative	
repetition rate	250 Hz	
pulse period	4.0 ms	
pulse width	300 μ s	
pulse amplitude	4 V to 15 V	

Table 4-5

SYNCHRONIZATION

(Option 7)

(Slow Sweep)

Characteristic	Performance Requirement	Supplemental Information
SLOW SWEEP Triggering Signal	APL change from 10% or less to 90%	Front-panel selectable for either + or - level change.
Sensitivity	400 mV to 2V peak-to-peak composite video with APL change.	
Rate	0.2 Hz or more.	Free runs at rates less than 0.2 Hz or with no triggering signal.
Input		Internal or External

Table 4-5 (cont)

Characteristic	Performance Requirement	Supplemental Information
50/60 Hertz Squarewave Triggering Frequency Range	From less than 50 Hz to more than 60 Hz.	
Signal		A 50 to 60 Hz squarewave with no field-sync and filtered line-sync.
Sensitivity	400 mV peak-to-peak min. to 3 V peak-to-peak max.	
Input Impedance		Approximately 10 kilohm ac coupled
Input Acquisition		Rear-panel AUXiliary SYNC loop-thru input connector.
Actuation		Simultaneous use of the INTERNAL and EXTERNAL SYNC switches.

Table 4-6
HORIZONTAL SYSTEM

Characteristic	Performance Requirement	Supplemental Information
Sweep Timing Accuracy 5 μ s/DIVision 10 μ s/DIVision 2 FIELD	$\pm 2\%$ (center 10 divisions) $\pm 2\%$ (center 10 divisions)	Proportional to the line-rate sweeps (5 and 10 μ s/division).
Linearity 5 μ s/DIVision 10 μ s/DIVision 2 FIELD SLOW SWEEP (Option 7)	$\pm 1\%$ $\pm 1\%$ ± 0.5 division $\pm 5\%$ of full-screen over the length of the sweep.	
Magnified Sweep Timing Accuracy X5 (1 μ s/DIV.) X10 (0.5 μ s/DIV.) X20 (0.25 μ s/DIV.) X25 (0.2 μ s/DIV.) X50 (0.1 μ s/DIV.)	Center 10 div. of unmagnified sweep. $\pm 1\%$ $\pm 2\%$ $\pm 3\%$ $\pm 3\%$ $\pm 3\%$	Calibrated at 1 μ s/DIV.
Linearity X5 (1 μ s/DIV.) X10 (0.5 μ s/DIV.) X20 (0.25 μ s/DIV.) X25 (0.2 μ s/DIV.) X50 (0.1 μ s/DIV.)	$\pm 2\%$ $\pm 2\%$ $\pm 2\%$ $\pm 2\%$ $\pm 2\%$	

Table 4-6 (cont)

Characteristic	Performance Requirement	Supplemental Information
VARIABLE MAGNIFIER (1481, 1482 and 1485 only) Range	At least $\pm 20\%$	
UNCALIBRATED Indicator		Front-panel lamp indicates when the control is in a position other than detent.
SLOW SWEEP (Option 7) Duration	4 to 12 seconds, variable with front-panel control.	
Indicator		Front-panel indicator lit when slow sweep is operating but not actually running.
RGB/YRGB Staircase Input	Approximately 12 volts for 12.7 divisions of deflection. DC signal levels, plus peak ac, not to exceed -12 to $+12$ volts. maximum ac signal level is 12 volts peak-to-peak.	Staircase is positive-going.
Sweep length RGB		
2 FIELD	27% to 33% of normal sweep.	
10 $\mu\text{s}/\text{DIV.}$	27% to 33% of normal sweep.	
5 $\mu\text{s}/\text{DIV.}$	27% to 33% of normal sweep.	
YRGB		
2 FIELD	20% to 25% of normal sweep.	
10 $\mu\text{s}/\text{DIV.}$	20% to 25% of normal sweep.	
5 $\mu\text{s}/\text{DIV.}$	20% to 25% of normal sweep.	
Sweep Repetition Rate		
2 FIELD	Field rate of applied video.	
5 or 10 $\mu\text{s}/\text{DIVISION}$	Line rate of applied video.	
EXTERNAL HORIZONTAL Input Sensitivity	5 volts = 10 division	Dc-coupled, positive-going from 0V. Crt is unblanked with no provision for external blanking or unblanking.
Linearity	$\pm 1\%$	
Input Impedance		Approximately 10 kilohms.

Table 4-6 (cont)

Characteristic	Performance Requirement	Supplemental Information
WAVEFORM COMPARISON LOCATE Range	Will place location index anywhere on 5 μ s/DIVision or 10 μ s/DIVision unmagnified sweep.	Range reduced by one-half with magnified 10 μ s/DIVision sweep.
OVERLAY Range	Will overlay the selected portion of sweep, marked by the locate index, on portion of the sweep preceding the index.	5 μ s/DIVision or 10 μ s/DIVision unmagnified.
LINE STROBE OUTPUT	Incidence and duration dictated by line selection.	TTL-amplitude.

Line Selection

Variable (VAR) selects a single line from approximately line 20 of the selected field (see Field Selection) through the next field and vertical interval to approximately line 8. Any line intensified in 2 FIELD will be the one displayed in 5 μ s/DIVision, or the first line displayed in 10 μ s/DIVision sweep speeds.

15 LINES operation covers the same range, but intensifies a block of 15 consecutive lines. In 2 FIELD display, this intensification shows up as a block of lines. At 10 μ s/DIVision, a two-line display of increased brightness, starting with the first intensified line (in 2 FIELD) will be seen. At 5 μ s/DIVision, a single brightened line will be seen, again beginning with the first intensified line. See Figure 4-2.

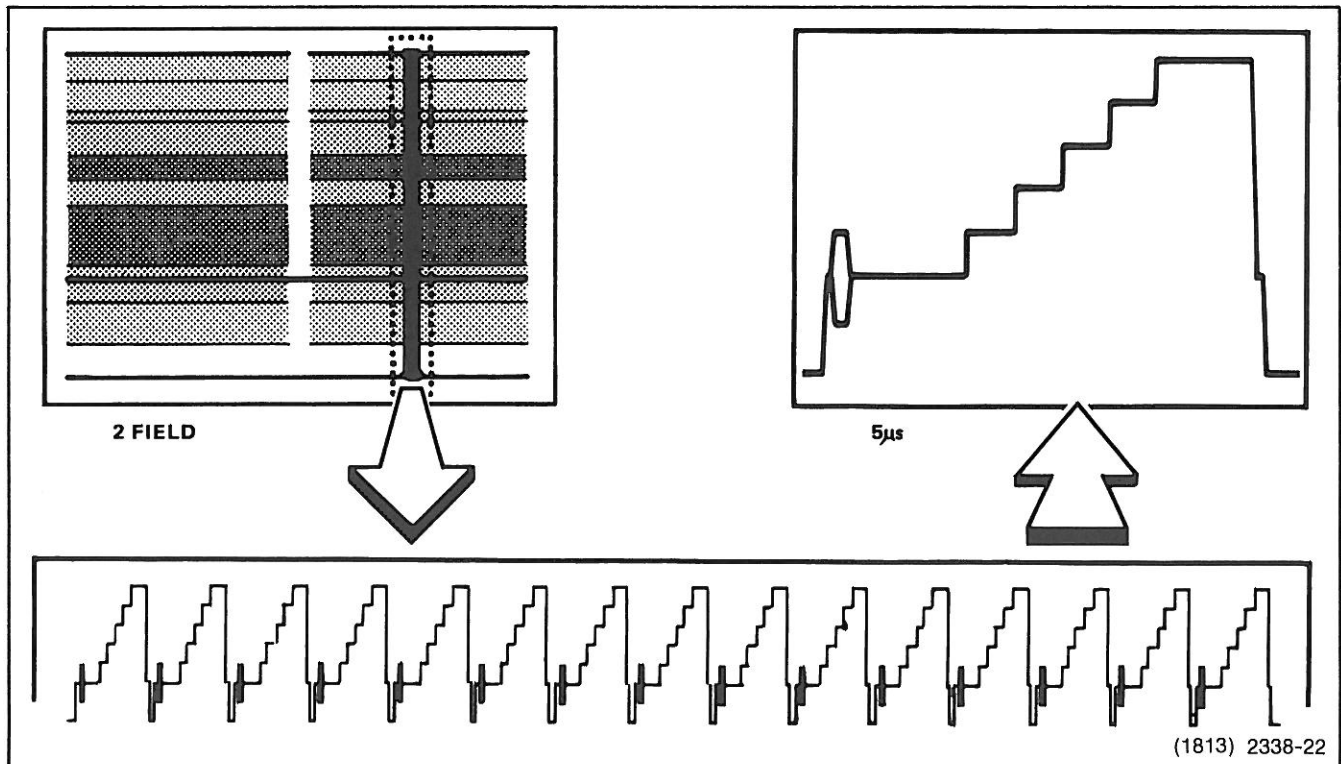

Fig. 4-2. 15-Line display mode.

Digital (DIG) selects any one of 13 lines, the 9th through the 22nd, of the selected field (this includes lines 322 through 335 PAL and 272 through 285 PAL-M). In 2 FIELD displays, the digitally-selected line is intensified. In 10 μ s/DIVision, the first line displayed is the digitally-selected one.

The display starts at about line 20 of the selected field and goes on through the next full field, terminating at about line 8 of the next complimentary field. (For example, starts on an even field and ends at the beginning of the next even field.)

Field Selection

The FIELD Selector is a set of four push-buttons providing positive field-selection. In the PAL systems where four distinct fields exist (Bruch Sequence), it is possible to select each field individually as well as the odd and even field-pairs. In NTSC, the odd and even fields are all that are identifiable.

ALL FIELDS provides a method of time-overlaying the even and odd fields. All line selection modes are functional; however, for 15 LINES and VARIable, the VARIable LINE SELECTOR must be in the first field of a normal 2 FIELD display. ALL FIELDS display is selected by simultaneously pushing the center-two FIELD Selector pushbuttons.

**Table 4-7
POWER SOURCE**

Characteristic	Performance Requirement	Supplemental Information
Mains Voltage Ranges	100 Vac \pm 10%	
	110 Vac \pm 10%	
	120 Vac \pm 10%	
	200 Vac \pm 10%	
	220 Vac \pm 10%	
	240 Vac \pm 10%	
Frequency	48 to 62 Hertz	
Crest Factor		At least 1.3
Maximum Power Consumption	75 watts	

**Table 4-8
ENVIRONMENTAL CHARACTERISTICS**

Characteristic	Performance Requirement	Supplemental Information
Temperature Operating Storage	0°C to 50°C -40°C to +65°C	
Altitude Operating Storage	To 15,000 feet To 50,000 feet	

Table 4-9

MECHANICAL CHARACTERISTICS

Characteristics	English Units	Metric Units
Cabinet Model		
Length	16.95 inches	43 cm
Width	8.50 inches	21.6 cm
Height	8.25 inches	21 cm
Net Weight	21 lb. 8 oz.	9.81 kg
Domestic Shipping Weight	28 lb. 8 oz.	12.9 kg
Export Shipping Weight	41 lb. 8 oz.	18.8 kg
Rackmount Model		
Length	18 inches	45.7 cm
Width	19 inches	48.3 cm
Height	5.25 inches	13.3 cm
Net Weight	24 lb. 9 oz.	11.2 kg
Domestic Shipping Weight	53 lb. 2 oz.	24.1 kg
Export Shipping Weight	75 lb. 2 oz.	34.1 kg

PERFORMANCE VERIFICATION PROCEDURE

This procedure verifies the Performance Requirements of the Electrical Characteristics found in Section 4. Steps at the end of the procedure are for the various operating options; i.e., Option 1, X10 Probe (these options may or may not be present in the instrument under test), allows for a single verification procedure for all models.

If the operation of this instrument is found to be outside the performance requirements, it should be referred to a qualified service technician for re-adjustment.

1480-Series Waveform Monitors have two basic graticule scales. One is used in the NTSC countries, and is referred to in this procedure as the NTSC graticule. The other, scaled for use with PAL standards, is identified as the CCIR graticule. The horizontal time-scale is the same for both because the 1480-Series time-base is in microseconds (μs) rather than increments of line time. The major difference lies in the vertical scales, 0 to 1 volt for the CCIR graticule and -40 to $+100$ IRE for the NTSC graticule. Where amplitude measurements are made in this procedure, the results are given in both mV and IRE.

Through most of this procedure, the instrument is operating in a $75\ \Omega$ impedance system. A $75\ \Omega$ end-line termination should be used on the open side of the loop-thru connector pair when termination is required.

Front- and rear-panel control and connector names on the 1480-Series instrument under test are capitalized; for example, VOLTS FULL SCALE. Control and connector names on test equipment have only the first letter capitalized; for example, Time/Div.

TEST EQUIPMENT REQUIRED

The test equipment listed here was used in preparing this procedure. The measurement capabilities described are the minimum required to verify instrument performance. Each piece of test equipment is assumed to be operating within its stated specifications. If alternative equipment is used, it must meet or exceed these requirements.

Some additional test equipment is required to check the performance of the options for the 1480. This equipment is listed at the beginning of the optional step to be performed. If this instrument contains options other than 2, 3, or 6, be sure to check the Additional Equipment Required list for that option.

1. Video Signal Source

Capable of generating color bars, composite sync, and modulated staircase test signals.

Standard	Recommended Instrument
NTSC	Tektronix 140
PAL	Tektronix 145
PAL-M	Tektronix 145-M

2. Digital Voltmeter

Accurate within 0.1% for dc volts from -4500 to $+200$ V. Example: TEKTRONIX DM 501 with a high-voltage probe (Tektronix Part Number 010-0277-00). (See item 6.)

3. Leveled Sine-Wave Generator

Capable of amplitudes from 0.2 volt peak-to-peak to 5 volts peak-to-peak, frequency range from 50 kHz (reference) to 10 MHz. Example: a TEKTRONIX SG 503. (See item 6.)

4. Time-Mark Generator

Capable of generating time-marks at intervals from 100 ns to 10 μs , with accuracy adjustable to within 1 part in 10^{-7} . Example: A TEKTRONIX 184 (if available).

5. Ramp Generator

Capable of generating a 5-volt ramp. Example: a TEKTRONIX RG 501. (See item 6.)

6. Power Module

For powering and housing TEKTRONIX DM 501, TG 501, RG 501, and SG 503 units. (Required if using these units.) TEKTRONIX TM 504.

Performance Verification—1480-Series (SN B060000-up)

7. Test Oscilloscope

Dual Time-Base. Range from 50 ns/Div to 5 s/Div with provisions for a delaying sweep and television triggering.

Differential Comparator. Bandwidth, dc to 30 MHz; minimum deflection factor, 1 mV/Div; two channels capable of differential operation.

Dual-Trace Amplifier. Vertical amplifier independent of the Differential Comparator. Bandwidth dc to 30 MHz; minimum deflection factor 5 mV/Div.

Example: a TEKTRONIX 7603 with 7B53A Option 5 Dual Time-Base, 7A13 Differential Comparator, and 7A18 Dual-Trace Amplifier.

8. Return Loss Bridge

Tektronix Part Number 015-0149-00.

9. Television Test Signal Generator

Capable of generating 3-step and 4-step RGB/YRGB signals. Example: a TEKTRONIX 067-0601-00 Television Test Signal Generator.

10. 75 Ω Coaxial Cable

42 inches long, four each. Tektronix Part Number 012-0074-00.

11. 75 Ω End-Line Termination

Four each, Tektronix Part Number 011-0102-00.

12. 75 Ω Feed-Through Termination

Two each, matched within 0.2%. Supplied as accessories with the Return Loss Bridge (item 8). Tektronix Part Number 011-0103-00.

13. 75 Ω Feed-Through Termination

Tektronix Part Number 011-0103-02. Two each.

14. 50 Ω to 75 Ω Minimum Loss Attenuator

Tektronix Part Number 011-0057-00.

15. Attenuators

2X—Tektronix Part Number 011-0069-02.

5X—Tektronix Part Number 011-0060-02.

10X—Tektronix Part Number 011-0059-02.

16. Bnc Cable Tee-Connector

Tektronix Part Number 067-0525-00.

17. P6101 1X Probe

Tektronix Part Number 010-6101-01.

18. P6105 10X Probe

Tektronix Part Number 010-6105-01.

19. 1.5-dB Attenuator

Must be constructed by customer as shown below:

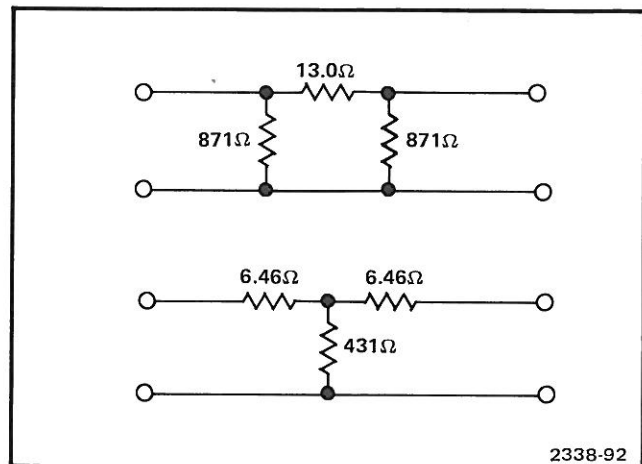

75 Ω 1.5 dB Attenuators

PROCEDURE

1. Check Astigmatism

a. Connect the video signal source to the 1480-Series Video INPUT A Connector and terminate the loop-through connector into 75 Ω . See Figure 5-1.

b. Set the INTENSITY control to about "2 o'clock" and adjust the front-panel FOCUS control for a sharp, well-defined display.

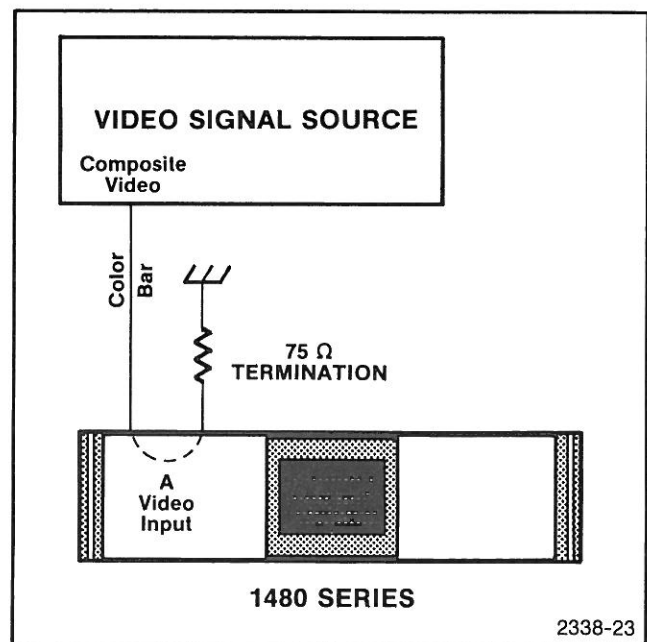

Fig. 5-1. Initial connections for 1480-Series performance check.

2. Check Magnified Intensification and Focus Tracking

a. Alternately press the LINE SELECTOR OFF and DIG pushbuttons, without readjusting FOCUS or INTENSITY. Check that the display maintains its definition and brightness.

b. Press the LINE SELECTOR OFF pushbutton.

c. Rotate the MAGNIFIER switch throughout its range and check that the display maintains its brightness over the MAGNIFIER range.

3. Check Geometry and Trace Rotation

a. Set the INPUT selector to B, DC CPL'D and position the trace to the graticule center-line. (0.5 V or 40 IRE).

b. Check that the trace is level with the center graticule line. If not, adjust TRACE ROTATION so that the trace is level with the center graticule line.

c. Check that the trace is approximately level with the top and bottom graticule lines.

4. Check Y Axis Alignment

a. Change the INPUT selector to A, DC CPL'D and set the VOLTS FULL SCALE selector to 0.2. Vertically position the display so that only the rising and falling portions of the display are visible.

b. Use the HORIZONTAL POSITION control to position the vertical lines across the crt screen. Check that the vertical lines are perpendicular to the bottom graticule line.

5. Check Vertical Gain Out (A VIDEO INPUT to AUX VIDEO OUT)

a. Connect the video signal source and test oscilloscope as shown in Fig. 5-2.

b. Set the test oscilloscope to 20 mV/Div, differential input with ac coupling. Shut off the test generator chrominance.

c. Check the display on the test oscilloscope for 5 mV or less amplitude, excluding transitional spikes.

6. Check PIX MONITOR OUT Gain

a. Change the output cable from the AUX VIDEO OUT connector to the PIX MONITOR OUT connector.

b. Check for a display amplitude of 20 mV or less, excluding transitional spikes.

7. Set Front-Panel Gain Adjustment

a. Press the DC RESTORER, SYNC TIP, and CAL pushbuttons.

b. Check for 1-volt equivalent display height.

c. Adjust GAIN control, if necessary, for 1-volt equivalent display height.

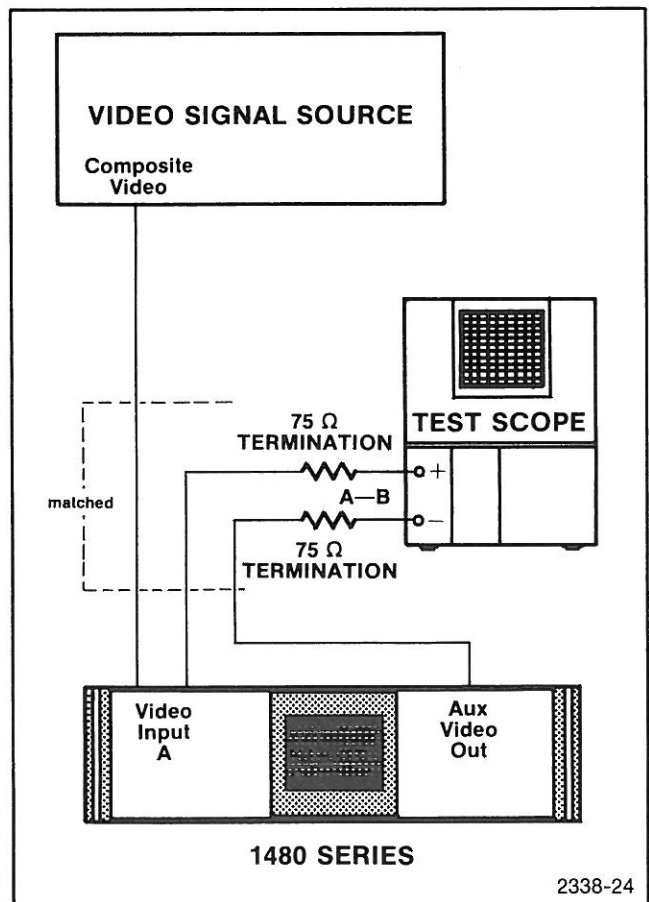

Fig. 5-2. Setup for 1480-Series Gain Measurement.

Performance Verification—1480-Series (SN B060000-up)

8. Check A to B Input Gain Ratio

a. Set the test signal generator Variable APL or % Peak White to 100 and the 1480-Series VOLTS FULL SCALE selector to 1.0.

b. Check display amplitude, 1.0 volt or 140 IRE from sync tip to peak white, ± 0.42 IRE (NTSC) or ± 3 mV (CCIR). Note exact amplitude.

c. Change the video input cable to the 1480-Series VIDEO INPUT B connector and change the 75 ohm termination to the VIDEO INPUT B loop-thru connector. Change the 1480-Series INPUT switch to B, DC CPL'D.

d. Check display amplitude and compare to that noted on the A INPUT, $A = B \pm 2$ mV (CCIR) or 0.28 IRE (NTSC).

9. Check VARIABLE VOLTS FULL SCALE Range

a. Check the amplitude of the sync pulse (40 IRE NTSC or 300 mV CCIR).

b. Rotate the VARIABLE VOLTS FULL SCALE control just out of detent and check sync pulse amplitude, 56 IRE (NTSC) or 420 mV (CCIR), or more.

c. Rotate the VARIABLE VOLTS FULL SCALE control fully counterclockwise and check the sync pulse amplitude for minimum amplitude, 20 IRE (NTSC) or 150 mV (CCIR) or less.

d. Return the VARIABLE VOLTS FULL SCALE control to its detented position.

10. Check AUX VIDEO IN Response Change

a. Connect a color bar test signal from the video signal source to the 1480-Series VIDEO INPUT A connector. Connect the VIDEO INPUT A loop-thru connector to the AUX VIDEO IN connector. Do not terminate. Set the RESPONSE switch to FLAT, and the DISPLAY switch to $5 \mu\text{s}/\text{div}$. Note the amplitude difference between the tops of the yellow and cyan bars. See Fig. 5-3, Color Bar.

b. Set the RESPONSE switch to AUX VIDEO IN.

c. Check the amplitude difference between the tops of the yellow and cyan bars; it should be the same as that noted earlier.

d. Set the VOLTS FULL SCALE selector to 0.2. Position the tops of the yellow and cyan bars to the top of the graticule, then to the bottom of the graticule.

e. Check for a difference of 7.5 mV or less between the yellow and cyan bars.

f. Set the VOLTS FULL SCALE selector to 1.0.

g. Check the amplitude difference between the tops of the yellow and cyan bars; it should be the same as that noted at the beginning of this step.

h. Connect the leveled sinewave generator output through a 50Ω to 75Ω Minimum Loss Attenuator, to the AUX VIDEO IN connector. Set the leveled sinewave generator for a frequency of 50 kHz and an output amplitude of 1 volt (140 IRE for NTSC). Do not change the leveled sinewave generator amplitude for the remainder of this step.

i. Change the 1480-Series VOLTS FULL SCALE selector to 0.5 and vertically position the display so that the top of the display is at the 1.0 V (or 100 IRE) line. Note: because the vertical sensitivity is doubled, the graticule scale is now halved, making the major vertical divisions 50 mV or 5 IRE. Minor divisions, where they occur, are now 5 mV or 1 IRE.

j. Check auxiliary video input response according to Table 5-1A (0.5 VOLTS FULL SCALE).

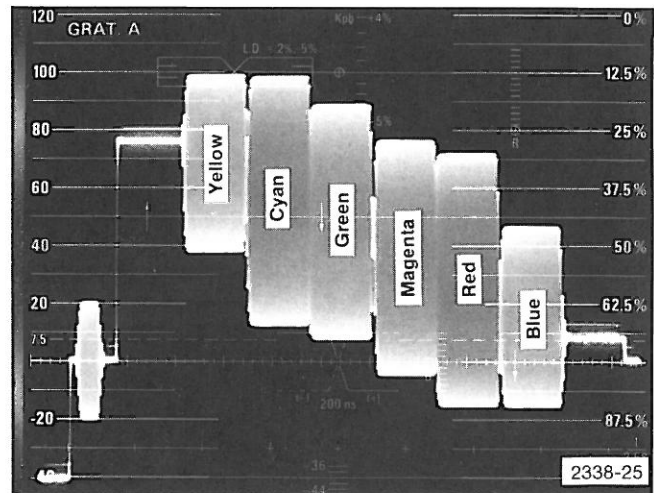

Fig. 5-3. NTSC Color Bar Signal (Color Bars are in identical location for PAL signal.)

Table 5-1A

VOLTS FULL SCALE	Leveled Sine-wave Generator	Amplitude	Limit
0.5	50 kHz	1 volt	Set as reference at 1 volt.
0.5	5 MHz	1 volt (Ref. 50 kHz)	$\pm 2\%$, 20 mV or 2.8 IRE
0.5	8 MHz	1 volt (Ref. 50 kHz)	+2%, -3% from 50 kHz reference
0.5	10 MHz	1 volt (Ref. 50 kHz)	+2%, -5% from 50 kHz reference

Table 5-1B

VOLTS FULL SCALE	Leveled Sine-wave Generator	Amplitude	Limit
0.2	50 kHz	1 volt	Set as reference at 1 volt.
0.2	5 MHz	1 volt (Ref. 50 kHz)	$\pm 2\%$, 20 mV or 2.8 IRE
0.2	8 MHz	1 volt (Ref. 50 kHz)	+2%, -3%
0.2	10 MHz	1 volt (Ref. 50 kHz)	+2%, -5%

k. Return the leveled sine-wave generator frequency to 50 kHz. Change the 1480-Series VOLTS FULL SCALE selector to 1.0 and check for 1 volt of display amplitude. Do not change the leveled sine-wave generator amplitude for the remainder of this step.

l. Set the 1480-Series VOLTS FULL SCALE selector to 0.2 and vertically position the top of the display to the 1.0 V (or 100 IRE) line. Note: because the vertical sensitivity has been increased by a factor of five, the graticule scale reduces by a factor of five. Each major division is now 20 mV or 2 IRE instead of 100 mV or 10 IRE. Minor divisions are now 2 mV or 0.4 IRE.

m. Check auxiliary video input response according to Table 5-1B (0.2 VOLTS FULL SCALE).

11. Check Common -Mode Rejection

a. Connect the video signal source composite video output through a 75 Ω feed-through termination and the bnc cable tee connector to the A and B VIDEO INPUTS. Do not terminate the loop-through connectors.

b. Set the video signal source for a 90% APL (average picture level) modulated pedestal signal.

c. Set the DISPLAY to 5 $\mu\text{s}/\text{Div}$, INPUT to A-B, DC CPL'D and VOLTS FULL SCALE to 0.2.

d. Check display amplitude for 70 mV or less.

12. Check A and B Frequency Response

a. Connect the leveled sine-wave generator output through the 50 Ω to 75 Ω minimum loss attenuator, a 75 Ω feed-thru termination, and the bnc cable tee connector to the A and B VIDEO INPUTS. Do not terminate the loop-thru connectors.

b. Set the leveled sine-wave generator frequency to 50 kHz and amplitude for 140 IRE units, or 1-volt display height.

c. Set the leveled sine-wave generator frequency to 5 MHz.

d. Check for a display height of 140 IRE or 1 V ±2%.

e. Set INPUT to B, AC CPL'D.

f. Check for a display height of 140 IRE or 1 V ±2%.

g. Check frequency response for A and B VIDEO INPUTS as in Table 5-2.

Table 5-2

Frequency	Limit		
0.05 MHz	Reference—140 IRE NTSC, 1 V equivalent display height PAL		
0.44 MHz	1 Volt 140 IRE	±2%	20 mV 2.8 IRE

13. Check AUX VIDEO OUT Response

a. Connect the video signal source composite video output through a 75 Ω feed-thru termination and the bnc cable tee connector to the A and B VIDEO INPUTS. Do not terminate the inputs.

b. Connect the AUX VIDEO OUT through the 1.5 dB attenuator to the AUX VIDEO IN connector.

c. Set the video signal source for a color bar test signal output.

d. With the RESPONSE switch in the FLAT position, generally note the amplitude of the chrominance portion of the display, and specifically note the amplitude difference between the yellow and cyan bars; note also the peak-to-peak amplitude of the composite signal.

e. Set the RESPONSE switch to AUX VIDEO IN.

f. Check the peak-to-peak display amplitude of the composite signal; it should be within 5% of that noted previously.

g. Check the chrominance amplitude and the amplitude difference between the yellow and cyan bars; it should be within 0.5% of that noted previously.

14. Check IRE Filter (NTSC only)

a. Connect an NTSC video signal source to the 1480-Series VIDEO INPUT, A connector and terminate the loop-thru connector in 75 Ω.

b. Set the RESPONSE switch to IRE, and the INPUT switch to A, AC CPL'D.

c. Set the video signal source for a five-step staircase, modulated with 20 IRE of subcarrier step.

d. Check that the luminance portions of the signals have no preshoot, overshoot, or ringing. Chrominance on the staircase should be 2.9 IRE or less.

15. Check LOW PASS Filter

a. Press the CAL and DC RESTORE SYNC TIP pushbuttons.

b. Set the RESPONSE switch to LOW PASS.

c. Check the corner of the leading edge of the calibrator square-wave for 0.5% (5 mV or 0.7 IRE) or less overshoot or ringing.

16. Check DIFF'D STEP Filter

a. Connect the video signal source composite video output to the 1480-Series VIDEO INPUT A connector and terminate the loop-thru connector in 75 Ω.

b. Set the RESPONSE switch to DIFF'D STEP and press the OPER pushbutton.

c. Set the video signal source for a five-step staircase, modulated with 140 mV or 20 IRE of subcarrier.

d. Check the amplitude of the differential-step risers, 5X normal. The differentiated pulses should have 1% or less preshoot, overshoot and ringing.

e. Disconnect the composite video and connect the subcarrier from the video signal source to the 1480-Series instrument.

f. Check that the displayed subcarrier is 20 mV (or 2.8 IRE) or less.

17. Check 3.58 MHz Bandpass Filter (if used)

a. Connect the video signal source color bar signal to the 1480-Series VIDEO INPUT A connector and terminate the loop-thru connector in 75 Ω .

b. Set the VOLTS FULL SCALE AND VOLTS FULL SCALE VAR so that the red bar is 100 IRE in amplitude. See Fig. 5-4.

c. Set RESPONSE to 3.58 BANDPASS.

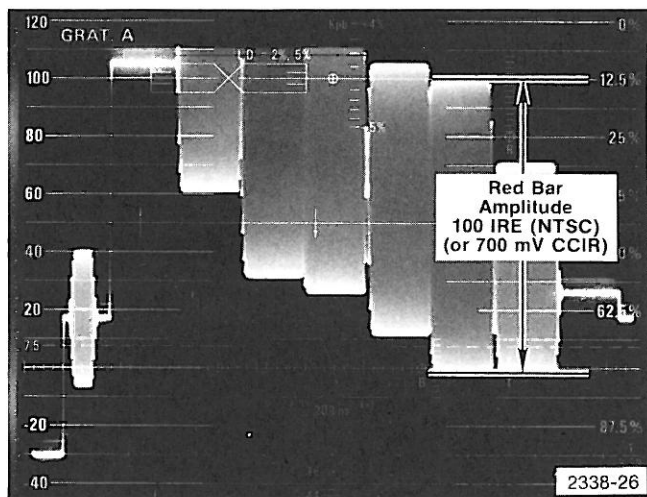

Fig. 5-4. Red Color Bar with amplitude increased to 100 IRE (NTSC).

Performance Verification—1480-Series (SN B060000-up)

d. Check that the red bar is within 1% of the amplitude set earlier in this step. The tops of the bars should be flat, and rise- and fall-time of the color burst should be nearly identical.

e. Disconnect the composite video signal and connect the leveled sine-wave generator to the 1480-Series instrument. Set the leveled sine-wave generator frequency to 3.58 MHz and amplitude for a convenient reference (100 IRE).

f. Check that the display amplitude is 3 dB from the reference (100 IRE at 3.58 MHz) at 3.1 to 3.4 MHz and 3.8 to 4.0 MHz.

18. Check 4.43 MHz Bandpass Filter (if used)

a. Connect the video signal source to the VIDEO INPUT A connector and terminate the loop-thru connector in 75 Ω . Set the video signal source for a standard color bar test signal.

b. Set the 1480-Series VOLTS FULL SCALE selector and the VOLTS FULL SCALE VAR so that the red bar is 700 mV in amplitude.

c. Set the RESPONSE selector to 4.43 BANDPASS.

d. Check that the red bar is within 1% of the amplitude set earlier in this step. The tops of the bars should be flat, and the rise- and fall-time of the color burst should be nearly identical.

e. Disconnect the composite video signal and connect the leveled sine-wave generator signal to the 1480-Series instrument.

f. Set the leveled sine-wave generator frequency for 4.43 MHz and amplitude for a convenient reference (1 Volt).

g. Check that the display amplitude is 3 dB from the reference (700 mV at 4.43 MHz) at 3.9 to 4.1 MHz and 4.7 to 4.9 MHz.

Performance Verification—1480-Series (SN B060000-up)

19. Check Calibrator Accuracy

a. Press the CAL and DC RESTORER SYNC TIP pushbuttons.

b. Connect the AUX VIDEO OUT through 75 Ω termination to the test oscilloscope differential comparator + input.

c. Set the test oscilloscope Time/Div to 50 μ s, Volts/Div to 50 mV, and for comparison voltage operation.

d. Connect the test oscilloscope differential comparator Vc out to the digital voltmeter input. Connect the other digital voltmeter lead to the test oscilloscope ground.

e. Set the test oscilloscope differential comparator Vc to 0000. Vertically position the bottom of the square-wave to graticule center. Note the digital voltmeter reading.

f. Rotate the differential comparator Fine Comparison Voltage control to set the top of the square-wave to graticule center. Check that the amplitude of the square-wave is 1 V \pm 2 mV.

g. Press the DC RESTORER BACK PORCH pushbutton.

h. Check for a square-wave amplitude of 700 mV \pm 0.5% (3.5 mV) for models with CCIR internal graticule scale, and 100 IRE \pm 0.5% (0.5 IRE) in NTSC models.

20. Check GAIN

a. Press the DC RESTORER SYNC TIP pushbutton.

b. Check that the 1480-Series display is 1 volt \pm 0.2%.

c. Adjust the front-panel GAIN control for a 1-volt display, if necessary.

21. Check VOLTS FULL SCALE accuracy

a. Connect the television test signal generator composite video through a 75 Ω termination to the VIDEO INPUT A connector.

b. Adjust the television test signal generator amplitude and APL for a 1-volt display.

c. Set the VOLTS FULL SCALE selector to 0.5 and add the 2X Attenuator in series with the 75 Ω termination.

d. Check for a display amplitude of 1-volt \pm 3%.

e. Set the VOLTS FULL SCALE switch to 0.2 and replace the 2X Attenuator with the 5X Attenuator.

f. Check for a display amplitude of 1-volt \pm 3%.

22. Check Horizontal Limiters

a. Connect the video signal source to the VIDEO INPUT A connector.

b. Set the 1480-Series RESPONSE switch to FLAT, DISPLAY switch to 10 μ s and MAGNIFIER to .1 μ s/Div. Rotate the HORIZONTAL POSITION control throughout its range.

c. Check that the trace is not visibly limited or folded back on screen at any point in the range of the HORIZONTAL POSITION control.

23. Check Magnifier Registration

a. Set the DISPLAY switch to 2 FIELD and center the display, using the HORIZONTAL POSITION control.

b. Set the MAGNIFIER control to X50 and rotate the HORIZONTAL POSITION control to set the last field-sync pulse to graticule center.

c. Set the MAGNIFIER control to OFF.

d. Check that the last field-sync pulse is within 0.5 division of graticule center.

24. Check Horizontal Gain and Timing

a. Disconnect the composite video and connect the time mark generator to the 1480-Series VIDEO INPUT A connector. Set the time mark generator for 10 μ s markers.

b. Apply a trigger from the time mark generator to the EXTERNAL SYNC A input connector.

c. Press SYNC EXT and DIRECT pushbuttons.

- d. DISPLAY is at 10 $\mu\text{s}/\text{DIV}$.
- e. Check for a display of 1 time-mark/div. within 2%.
- f. Set the MAGNIFIER switch to 0.1 $\mu\text{s}/\text{DIV}$ and the time mark generator for 0.1 μs marks.
- g. Check the magnified display for 1 mark/div $\pm 3\%$ over the center 10 divisions of the unmagnified display. Total effective magnified display is 1270 divisions in length (12.7 div., magnified 100X). Specification applies to any portion of the center 1000 divisions at this magnification.
- h. Check magnified timing and linearity as in Table 5-3.

Table 5-3

TIME MARKERS	MAG	DISPLAY	LIMIT
1 μs	0.2 μs	1 mark/5 div	$\pm 3\%$
1 μs	0.25 μs	1 mark/4 div	$\pm 3\%$
1 μs	0.5 μs	1 mark/2 div	$\pm 2\%$
1 μs	1.0 μs	1 mark/div	$\pm 1\%$

25. Check WAVEFORM COMPARISON Range

- a. Set the DISPLAY switch to 5 $\mu\text{s}/\text{DIV}$ and rotate the WAVEFORM COMPARISON OVERLAY control just out of detent. Notice the small blanked portion of the trace.
- b. Rotate the WAVEFORM COMPARISON LOCATE control to place the blanked portion at the start of the trace.
- c. Rotate the WAVEFORM COMPARISON OVERLAY control throughout its range.
- d. Check that the OVERLAY control has sufficient range to position the display completely off-screen.
- e. Set the DISPLAY switch to 10 $\mu\text{s}/\text{DIV}$ and repeat this step.

26. Check RGB/YRGB Operation

- a. Connect the video signal source composite video to the VIDEO INPUT A connector and terminate the loop-thru connector in 75 Ω .

Performance Verification—1480-Series (SN B060000-up)

- b. Set the INPUT switch to A, AC CPL'D, DISPLAY switch to 10 $\mu\text{s}/\text{DIV}$ and the MAGNIFIER selector to OFF.
- c. Press the SYNC INT and DIRECT pushbuttons.
- d. Connect J9034 on the rear panel for RGB/YRGB operation (ground pin D and connect RGB/YRGB steps to pin C).
- e. Connect a 3-step staircase from the television test signal generator to J9034 pin C and set the television test signal generator amplitude control for three video lines in 12.7 div. (If the 1480-Series is internally programmed for YRGB, substitute a 4-step staircase.) See Accessories in the rear of this manual for information on mating, male plug (P9034) for use with J9034.
- f. Check for a stable display, centered, without compression.

- g. Set the DISPLAY selector to 2 FIELD and check for a display that is three fields in 12.7 divisions. (Four fields if connected for YRGB.)

27. Check EXTERNAL HORIZ input (if activated)

For information on how to activate the External Horizontal mode, refer qualified service personnel to OPERATING CHANGES in Section 6 (Installation).

- a. Set the DISPLAY switch to EXT.
- b. Connect a 5-volt positive-going ramp from the ramp generator to the EXT HORIZ input.
- c. Check for a trace that is 10.0 div. $\pm 3\%$.

28. Check Field Selection

- a. Apply a composite video signal from the video signal source to the 1480-Series VIDEO INPUT A connector and terminate the loop-thru connector in 75 Ω .
- b. Setup the video signal source to supply known signals in the vertical interval. For example, the NTSC, STOC1, composite test signal on line 17 of the even field.
- c. Set the 1480-Series RESPONSE switch to FLAT, DISPLAY selector to 2 FIELD and MAGNIFIER switch to X20.

Performance Verification—1480-Series (SN B060000-up)

d. Horizontally position the interval that occurs between the displayed fields to graticule center. When the field selection pushbutton that corresponds to the even field is pressed, the odd field interval will be displayed. Assume that line 17 of the even field is carrying the composite test signal. When the EVEN pushbutton is pressed, the displayed interval is for the odd field and no composite test signal will be displayed on line 17.

Procedure for checking PAL fields, using the Bruch Blanking Sequence, appears in Television Products Application Note number 16, "Verifying the Bruch Blanking Sequence", which is located in Section 3 of this instruction manual. Care should be exercised when making this check, because the sequence may be in error on the video coming from the video signal source.

29. Check Line Selection

a. Connect the video signal source composite video output to the VIDEO INPUT A connector and terminate the loop-thru connector in 75 Ω .

b. Set the VOLTS FULL SCALE selector to 1.0, RESPONSE selector to FLAT, DISPLAY selector to 10 $\mu\text{s}/\text{DIV}$, and MAGNIFIER switch to OFF.

c. Press the LINE SELECTOR DIG and EVEN FIELD pushbuttons.

d. Again set the video signal source for known signals in the vertical interval.

e. Check that the line displayed and the line selected by the 1480-Series LINE SELECTOR switch agree.

f. Press the LINE SELECTOR VAR pushbutton and set the DISPLAY selector to 2 FIELD. Rotate the VAR control and check that the selected line is intensified, and that the intensified zone can be moved the width of the display with the VAR control.

g. Press the LINE SELECTOR 15 LINES pushbutton. Rotate the VAR control and check that fifteen consecutive lines can be intensified and the zone can be moved the width of the display with the VAR control.

30. Check PIX MONITOR OUT and LINE STROBE OUT

a. Connect the video signal source composite video signal to the VIDEO INPUT A connector.

b. Set the RESPONSE selector to FLAT, DISPLAY selector to 2 FIELD, VOLTS FULL SCALE selector to 1.0, and MAGNIFIER switch to OFF.

c. Press LINE SELECTOR VAR pushbutton.

d. Connect the PIX MONITOR OUT connector through a 75 Ω termination to the test oscilloscope vertical input.

e. Check that the line selected by the LINE SELECTOR controls is identified on the 1480-Series display by an intensified zone and on the test oscilloscope display by a 200 mV pedestal. The pedestal should be one-line duration in the 5 $\mu\text{s}/\text{DIV}$ DISPLAY and fifteen-lines duration with the 15 LINES pushbutton pressed.

31. Check Sync Range

a. Connect the video signal source composite video signal through a 5X attenuator and 75 Ω termination to the VIDEO INPUT A connector.

b. Set the VOLTS FULL SCALE selector to 0.2, RESPONSE selector to FLAT, and MAGNIFIER switch to OFF.

c. Check for a stable display.

d. Remove the 5X attenuator and the 75 Ω termination. Connect the composite video directly to the VIDEO INPUT A connector.

e. Check for a stable display.

f. Connect the video signal source composite video output through four 75 Ω terminations to the VIDEO INPUT A connector. Connect the other side of the VIDEO INPUT A loop-thru connector to the EXTERNAL SYNC A input connector.

g. Press the SYNC EXT pushbutton and check for a stable display.

h. Remove the four 75 Ω terminations. Connect the composite video signal directly to the VIDEO INPUT A connector and check for a stable display.

i. Replace the composite video with composite sync, connected through a 2X and a 10X attenuator and 75 Ω termination.

j. Check for a stable display.

k. Remove the two attenuators and the 75 Ω termination. Connect the composite sync directly to the VIDEO INPUT A connector.

l. Check for a stable display.

32. Check Sync Input Selector

a. Connect the video signal source composite video to the VIDEO INPUT A connector and terminate the loop-thru connector in 75 Ω . Connect the video signal source composite sync to EXTERNAL SYNC A input connector.

b. Set the VOLTS FULL SCALE selector to 1.0, MAGNIFIER switch to OFF, RESPONSE selector to FLAT, and DISPLAY selector to 2 FIELD. Press the SYNC DIRECT and EXT pushbuttons.

c. Set the Sync Input Selector on the rear panel to EXT SYNC ALWAYS (A), and check for a stable display.

d. Move the composite video to the VIDEO INPUT B connector, set the INPUT selector to B, and check for a stable display.

e. Change the Sync Input Selector to EXT SYNC SWITCHED WITH INPUT SWITCH (A) or (B), and check that the display is not locked.

f. Move the composite sync input to the EXTERNAL SYNC B connector, and check for a stable display.

33. Check Return Loss

a. Connect the return loss bridge output connectors to the test oscilloscope differential comparator inputs. Connect the leveled sine-wave generator output through the 50 Ω to 75 Ω minimum loss attenuator to the return loss bridge Input connector. Set the test oscilloscope differential comparator for differential operation and Volts/Div to .1.

b. Set the leveled sine-wave generator for 50 kHz. Check that the 75 Ω termination is not connected to the Unknown Arm of the return loss bridge, and adjust the

Performance Verification—1480-Series (SN B060000-up)

leveled sine-wave generator amplitude for a 500 mV display on the test oscilloscope.

c. Connect the return loss bridge unknown arm to the VIDEO INPUT A connector. Terminate the VIDEO INPUT A loop-thru connector with the termination that is normally connected to the Unknown Arm of the return loss bridge.

d. Check that the test oscilloscope amplitude is 2.5 mV or less.

e. Repeat the test for the VIDEO INPUT B and EXTERNAL SYNC A and B inputs.

f. Connect the return loss bridge Unknown Arm (do not terminate) to AUX VIDEO IN, AUX VIDEO OUT, and PIX MONITOR OUT connectors in sequence, while performing part g.

g. Check for a test oscilloscope amplitude of 11 mV or less at each of the connectors mentioned in part f.

Options

The remaining steps in this procedure check the performance of option circuits, beginning with Option 1 (X10 Probe Input). Each Option is identified individually.

Option 1, X10 Probe Input

Additional Equipment Required:

1. 10X Passive Probe. For example, P6105, Tektronix Part Number 010-6105-01.
2. One 50 Ω feed-thru termination, Tektronix Part Number 011-0049-01.

34. Check X10 PROBE GAIN Range

a. Compensate the 10X probe using the test oscilloscope vertical amplifier and calibrator.

b. Move the 10X probe to the 1480-Series X10 PROBE INPUT. Plug the probe tip into the CAL OUTPUT connector. Switch the INPUT selector to PROBE and press the CAL and DC RESTORER SYNC TIP pushbuttons. Rotate PROBE GAIN to its extremes and check for 1 V, +10% and -10% at the respective ends of the control.

c. Adjust X10 PROBE GAIN for a 1-volt display height.

Performance Verification—1480-Series (SN B060000-up)

35. Check 10X PROBE GAIN

a. Press the OPER pushbutton. Connect the video signal source composite video to the VIDEO INPUT A connector. Terminate the loop-thru connector with a 75 Ω feed-through termination. Connect the 10X probe to the open end of the feed-through termination.

b. Compare displays with the INPUT switch alternately in PROBE and A positions. Check for less than 3% (3 mV) change in amplitude from A to PROBE.

36. Check 10X Probe HF Compensation

a. Check that the chrominance packets are identical in the A and PROBE positions of the INPUT switch.

37. Check Probe Calibrator Amplitude

a. Connect the 10X probe between the test oscilloscope and the X10 PROBE CAL OUTPUT.

b. Measure the CAL OUTPUT amplitude, using the differential comparator comparison voltage. Check for 1 V $\pm 0.5\%$ (0.5 mV).

Options 4 and 5, VTR Tone Wheel Sync Input

Additional Equipment Required:

1. Pulse Generator capable of 5 V output into 50 Ω from 5 Hz to 50 MHz, with variable period and duration. For example, Tektronix PG 501. (See item 6 of Equipment Required List.)
2. One 067-0621-00, Calibration Fixture, remote control for VTR waveform monitor.
3. Two coaxial cables, 50 Ω , 42", bnc connectors, 012-0057-01.
4. One 50 Ω Feed-through Termination, 011-0049-01.

38. Check Clamping

a. Connect the pulse generator minus (–) output to the 1480-Series SYNC loop-thru input connector using 50 Ω cable. Connect the second SYNC connector through 50 Ω cable and a 50 Ω termination to the test oscilloscope vertical input.

b. Connect composite video from the video signal source to the 1480-Series VIDEO INPUT A connector and terminate the loop-thru connector in 75 Ω .

c. Connect composite sync from the video signal source to the 1480-Series EXTERNAL SYNC A input connector and terminate the loop-thru connector in 75 Ω .

d. Connect the 067-0621-00 Calibration Fixture to J9034 on the 1480-Series rear panel.

e. Set the 1480-Series DC RESTORER selector to FAST, BACK PORCH, and SYNC to EXT. Set all switches on the 067-0621-00 up (Normal).

f. Set the test oscilloscope Time/Div to 0.5 ms and Volts /Div to 5. Set the pulse generator output amplitude for 3 volts, pulse duration for 300 μ s and period for 4.167 ms (4 ms for 625 line scanning system).

g. Rotate the 1480-Series vertical POSITION control to set the back porch of the displayed signal at blanking level.

h. Remove the 75 Ω termination from the VIDEO INPUT A connector. Check that the back porch of the displayed signal is clamped at blanking level. Replace the termination.

i. Set the 067-0621-00 Horizontal Display switch to 2 Field or Tone Wheel. Check to see that the back porch of the displayed signal remains at the blanking level.

j. Remove the termination from the VIDEO INPUT A connector. Check to see that the back porch of the displayed signal is not clamped. Replace the termination.

k. Rotate the DISPLAY switch to each position except EXT and check that the display does not change.

39. Check Sync Stability

a. Set the 067-0621-00 Ext Sync Source switch to Ext. Check for a stable display.

b. Remove the cable from EXTERNAL SYNC A loop-thru connector. Check for an unstable display. Replace the cable. Return the 067-0621-00 Ext Sync Source switch to Int.

40. Check Sweep Length

a. Set the RESPONSE switch to AUX IN. Set the 067-0621-00 Ext Sync mode switch to Tone Wheel. Check that the display does not flicker, remains stable, and is 12.5 div ± 0.5 div in length.

41. Check Maximum Input

a. Remove the termination from the test oscilloscope vertical input. Adjust the pulse generator for maximum output amplitude. Check to see that the display is unchanged.

Option 7 Slow Sweep

Additional Equipment Required:

One video signal source capable of generating a bounce signal. For example, TEKTRONIX 148 (PAL), 148-M (PAL-M), or 149A (NTSC) Test Signal Generator.

42. Check SLOW SWEEP Speed

a. Connect the output of the time mark generator to the 1480-Series VIDEO INPUT A connector. Set the DISPLAY switch to SLOW SWEEP + TRIG PLRT. Apply 1-second time marks.

b. Rotate the VAR DISPLAY control fully clockwise and check for five or less time marks per sweep.

c. Rotate the VAR DISPLAY control fully counterclockwise and check for 12 or more time marks per sweep.

43. Check SLOW SWEEP Trigger Polarity

a. Disconnect the cable from the time mark generator and connect it to the test signal generator Composite Video output. Set the test signal generator for an APL Bounce signal.

b. Check the start of the display. Display begins at maximum APL.

c. Change SLOW SWEEP TRIG PLRT to - (minus). Check start of the sweep; display should begin with trace at the blanking level.

Option 7 50/60 Hertz Triggering

Additional Equipment Required:

1. Pulse generator capable of 5 V output into 50 Ω from 5 Hz to 50 MHz, with variable period and duration. For example, TEKTRONIX PG 501. A function generator, such as the TEKTRONIX FG 503, may be substituted. (See item 6 of the Test Equipment Required list.)
2. Three Coaxial Cables, 50 Ω , 42", bnc connectors, 012-0057-01.
3. One 50 Ω Feed-Through Termination, bnc connectors, 011-0049-01.
4. One 50 Ω X10 Attenuator, bnc connectors, 011-0059-02.

44. Check 50/60 Hz Triggering Sensitivity

a. Connect the output of the pulse generator through a 50 Ω coaxial cable to the 1480-Series AUX SYNC INPUT. Loop-thru connect, with a 50 Ω coaxial cable, to the VIDEO INPUT A connector. Connect another 50 Ω coaxial cable from the other side of the VIDEO INPUT A loop-thru connector to the test oscilloscope vertical input, through the 50 Ω feed-through termination.

b. Using the test oscilloscope as an amplitude monitor, set the pulse generator for 3 volts of 50 Hz signal.

c. Set the 1480-Series DISPLAY selector to 2 FIELD and depress both INT and EXT SYNC pushbuttons.

d. Check for a triggered 1480-Series display of 2 full cycles of square wave.

e. Install the 50 Ω X10 attenuator in the cable from the pulse generator to the AUX SYNC INPUT. Using the test oscilloscope as an amplitude monitor, set the pulse generator for 400 mV at 50 Hz.

f. Check for a triggered 1480-Series display of 2 full cycles of square wave.

45. Check 50/60 Hz Triggering Frequency Range

a. Using the test oscilloscope as an amplitude monitor, set the pulse generator amplitude to 1 volt.

b. Rotate the pulse generator frequency control from 50 to 60 Hz and check for a triggered display of 2 full cycles of square wave from 50 to 60 Hz. (Disregard a small jump that occurs near 55 Hz. This is normal and provides for almost identical sweep length at 50 and 60 Hz).

