

Multichannel Scaler/Averager

Model SR430

1290 D Reamwood Avenue
Sunnyvale, CA 94089 USA
Phone: (408) 744-9040 • Fax: (408) 744-9049
www.thinkSRS.com • e-mail: info@thinkSRS.com

Copyright© 1999
All Rights Reserved
Revision 1.5 • 8/2007

 **SRS** Stanford Research Systems

TABLE OF CONTENTS

CONDENSED INFORMATION

Safety and Preparation for Use	3
Symbols	4
Specifications	5
Quick Performance Check	8
Abridged Command List	9

INSTRUMENT OVERVIEW

SR430 Overview	11
Trigger and Sync/Busy	11
Bin Clock Output	12
Ext Bin Clk Input	12
Signal Input and Discriminator	12
Timing	13
Data Acquisition	13
Add, Subtract, Toggle, and Inhibit	13
Aux, Test, Disk, and Interfaces	14

OPERATION

Front Panel Overview	15
Power	15
Video Display	15
Soft Keys	15
Keypad	16
Spin Knob	16
Disk Drive	16
BNC Connectors	16

Screen Display	17
Data Display	17
Cursor Display	18
Menu Display	18
Data Acquisition Status	18
Status Indicators	19

Keypad	21
Normal and Alternate Keys	21
START and STOP/RESET	21
Menu Keys	22
Entry Keys	22
CURSOR	22
AUTOSCALE	22
PEAK	23
CENTER	23
NORM	23
PRINT	23
HELP	23
LOCAL23	

Rear Panel	25
Power Entry Module	25
IEEE-488 Connector	25

RS232 Connector	25
Parallel Printer Connector	25
PC Keyboard Connector	26
BNC Connectors	26

MENUS

Levels Menu	27
Mode Menu	29
Display Menu	35
Setup Menu	37
Save Menu	47
Recall Menu	53
Math Menu	59
Plot Menu	67
Test Menu	69
Info Menu	73

INSTRUMENT SETUPS

Default Setup / Power On Clear	75
Choosing Bin Width & Record Length	76
Accumulation	76
Using the Trigger Offset	76
Using SYNC/BUSY76	

REMOTE PROGRAMMING

GPIB Communications	79
RS232 Communications	79
Status Indicators and Queues	79
Command Syntax	79
Interface Ready and Status	80

Detailed Command List	81
Level Control Commands	81
Mode Control Commands	82
Display Control Commands	83
Setup Commands	85
Save and Recall Commands	86
Math Operation Commands	87
Print and Plot Commands	89
Data Acquisition Control Commands	89
Data Transfer Commands	90
Interface Control Commands	91
Status Reporting Commands	91

Status Byte Definitions	92
Serial Poll Status Byte	92
Standard Event Status Byte	92
MCS Status Byte	93
Error Status Byte	94

File Formats			
Trace File	95	Printer Interface	117
Settings File	95	Video Graphics Interface	117
Program Examples	97	Disk Controller	117
IBM PC BASIC, RS232	97	GPIO Interface	117
Microsoft C, Nat'l Instruments GPIO	99	RS232 Interface	117
IBM PC BASIC, Nat'l Instruments GPIO	101	Expansion Connector	117
TEST AND CALIBRATION		Power Supply Board	118
Power	103	Unregulated Power Supplies	118
Screen Brightness	103	Power Supply Regulators	118
Fan	103	ECL Logic Board	119
Front Panel Tests	103	Signal Input	119
Power On Reset	103	Discriminators	119
Testing Data Acquisition Hardware	103	200 MHz Clock and Trigger Sync	119
Counting Problems	104	Bin Clock Generator	119
Calibration	105	Pulse Sorter	120
Signal Inputs	105	Counters	120
		Shift Register Inputs	120
		Control Signals	121
USING PHOTOMULTIPLIER TUBES		TTL Logic Board	121
PMT Selection for Photon Counting	107	Fast Record Buffers	121
Geometry	107	Fast Buffer Address Counter	121
Spectral Response	107	Accumulator	122
Gain and Risetime	107	Copy Buffer Address Counter	122
Dark Counts	107	Status and IO	122
PMT Base Design	108	Digital to Analog Converter	123
Dynode Biasing	108		
Snubbing	109	PARTS LISTS	125
Cathode Shielding	110	Control Board	125
Magnetic Shielding	110	Power Supply Board	129
Preamplifiers	110	ECL Logic Board	132
Gain Requirement	111	TTL Logic Board	138
Plateauing a PMT	111	Hardware	142
The 'Fast and Pretty Good' Way	111	Miscellaneous	144
TYPICAL EXPERIMENT		ADDENDUM	145
Energy Levels of Ruby	113		
Apparatus	113	SCHEMATIC DIAGRAMS	
Operation	113	CPU Board	
Instrument Configuration	114	Power Supply Board	
Data Acquisition	114	ECL Logic Board	
		TTL Logic Board	
CIRCUIT DESCRIPTION			
Circuit Boards	115		
Video Driver and CRT	116		
CPU Board	116		
Microprocessor System	116		
Keypad Interface	116		
Keyboard Interface	116		
Spin Knob	117		
Speaker	117		
Clock/Calendar	117		

SAFETY AND PREPARATION FOR USE

WARNING: Dangerous voltages, capable of causing injury or death, are present in this instrument. Use extreme caution whenever the instrument covers are removed. Do not remove the covers while the unit is plugged into a live outlet.

CAUTION

This instrument may be damaged if operated with the **LINE VOLTAGE SELECTOR** set for the wrong ac line voltage or if the wrong fuse is installed.

LINE VOLTAGE SELECTION

The SR430 operates from a 100V, 120V, 220V, or 240V nominal ac power source having a line frequency of 50 or 60 Hz. Before connecting the power cord to a power source, verify that the **LINE VOLTAGE SELECTOR** card, located in the rear panel fuse holder, is set so that the correct ac input voltage value is visible.

Conversion to other ac input voltages requires a change in the fuse holder voltage card position and fuse value. Disconnect the power cord, open the fuse holder cover door and rotate the fuse-pull lever to remove the fuse. Remove the small printed circuit board and select the operating voltage by orienting the printed circuit board to position the desired voltage to be visible when pushed firmly into its slot. Rotate the fuse-pull lever back into its normal position and insert the correct fuse into the fuse holder.

LINE FUSE

Verify that the correct line fuse is installed before connecting the line cord. For 100V/120V, use a 1 Amp fuse and for 220V/240V, use a 1/2 Amp fuse.

LINE CORD

The SR430 has a detachable, three-wire power cord for connection to the power source and to a protective ground. The exposed metal parts of the instrument are connected to the outlet ground to

protect against electrical shock. Always use an outlet which has a properly connected protective ground.

WARNING REGARDING USE WITH PHOTOMULTIPLIERS

The signal inputs may be damaged if a photomultiplier is used improperly with the photon counter. When left completely unterminated, a PMT will charge a cable to a few hundred Volts in a very short time. If this cable is connected to a signal input, the stored charge may damage the front-end transistors. To avoid this problem, provide a leakage path of about 100 K to ground inside the base of the PMT to prevent charge accumulation.

CONNECTION TO OTHER INSTRUMENTS

All front panel BNC shields are connected to the chassis ground and to the power outlet ground via the power cord. Do not apply any voltage to either the shields or to the outputs. The outputs are not protected against connection to any potential other than ground.

FURNISHED ACCESSORIES

- Power Cord
- Operating Manual

ENVIRONMENTAL CONDITIONS









OPERATING

Temperature: +10°C to +40°C
(Specifications apply over +18°C to +28°C)
Relative Humidity: <90% Non-condensing

NON-OPERATING

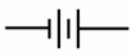
Temperature: -25°C to +65°C
Humidity: <95% Non-condensing

Symbols you may find on SRS products.

Symbol	Description
	Alternating current
	Caution - risk of electric shock
	Frame or chassis terminal
	Caution - refer to accompanying documents
	Earth (ground) terminal
	Battery
	Fuse
	On (supply)
	Off (supply)

SR430 MULTICHANNEL SCALER / AVERAGER

GENERAL INFORMATION

The SR430 Multichannel Scaler / Averager counts incoming pulses in successive time bins. A trigger starts a record of up to 32,704 time bins. The duration of the time bins is programmable from 5 ns to 10.5 ms. The number of signal pulses counted during each time bin is stored in memory. There is no dead time between bins. Each new trigger starts a record whose data is added to the bin by bin accumulation of all of the previous records. The result is a record of the sum (or average) of all counts in each time bin.

The trigger starts each record. The SYNC/BUSY output signals the beginning of the first time bin of the record. The BIN CLOCK output signals the boundaries of each time bin. During each time bin, input signal pulses are counted. At the end of the time bin, the counter data is stored in memory and the counter is reset. The double buffered design ensures that there is no dead time between bins and no pulses are missed at the bin boundaries.

After the record is complete, the data is added to the accumulation of all previous records. This only occurs after the record of data is acquired and results in a accumulation dead time of 250 ns X number of bins in the record (8 ms for 32k bins). After the accumulation is complete, the memory is re-armed for the next trigger.

The number of records accumulated is programmable 1 to 65,535 (or free run). The count capacity is 32,767 per bin per trigger. The total accumulation capacity per bin is also 32,767. The SYNC/BUSY output for each record remains high from the trigger until the end of accumulation. When SYNC/BUSY returns low, another trigger can be received.

The SR430 offers advanced functions such as Autoscale, Smoothing, Curve Fitting, non-volatile setup memories, data storage to disk, push button hardcopy to graphics printers and plotters, and GPIB and RS-232 interfaces. The SR430 is also easy to use. It has a menu based user interface which makes front-panel adjustments intuitive and straightforward. Entries are made with the front-panel knob or numeric keypad. On screen help is available at all times.

SPECIFICATIONS

SIGNAL INPUT

Bandwidth	dc to 250 MHz
Input impedance	50
Linear range	±300 mV (at input)
Input protection	±5 VDC, 50 V for 1 µs
Overload recovery	5 ns for <10 µs duration overload

DISCRIMINATOR

Referred to the signal input:	
Discriminator range	-300 mV to +300 mV
Resolution	0.2 mV
Slope	Positive or Negative
Accuracy	2 mV + 1%
Minimum pulse input amplitude	10 mV
Pulse pair resolution	10 ns (typical)
DISC view output	NIM level into 50
	There is a 20 ns insertion delay from signal input to discriminator output.

TRIGGER INPUT

Impedance	10 k
Threshold	-2.000 V to +2.000 V in 1 mV steps
Slope	Rising or Falling

SR430 Multichannel Scaler

Protection 15 VDC, 100 V for 1 μ s

INTERNAL TIME BINS

Bin width 5 ns, 40 ns, 80 ns, 160 ns, 320 ns, 640 ns, 1.28 μ s, 2.56 μ s, ...
10.486 ms. (10 ns or 20 ns bins are not available)

Accuracy 1 ns + 20 ppm of bin width

Jitter (rms) 100 ps + 10 ppm of delay from SYNC/BUSY output (Time bins are synchronous with the SYNC/BUSY output).

Indeterminacy 2.5 ns pk-pk with respect to the TRIGGER input

Insertion delay 45 ns from trigger to first bin. Rising edge of SYNC/BUSY output occurs at the beginning of the first bin. However, signal pulses arriving 25 ns after the trigger will be counted in the first bin.

EXTERNALLY CLOCKED TIME BINS

EXT BIN CLK Input Rising edge triggers next time bin.

Maximum frequency 4 MHz (250 ns minimum bin width)

Minimum pulse width high 100 ns

Minimum pulse width low 100 ns

Insertion delay Rising edge of SYNC/BUSY output occurs at first rising edge of EXT BIN CLK after TRIGGER. The beginning of the first bin occurs at the same time. (Time bins are synchronous with the SYNC/BUSY output).

COUNTERS/ACCUMULATION

Bins per record 1k to 16k in 1k increments (1024 to 32,704 including Trigger Offset)

Maximum count rate 100 MHz

Maximum count 32,767 per bin per trigger

Records per accumulation 1 to 64k (or free run)

Maximum accumulation 32,767 per bin in Add mode, \pm 16,383 per bin in Toggle, or External mode.

Add/Subtract Records may be added or subtracted (Toggle between add and subtract every N triggers where N is programmable). External subtract input may also control the toggle.

TRIGGER RATE

Minimum period between triggers $T_p = \text{Record time} + \text{Accumulation time} + \text{Overhead}$
 $= (\text{Number of Bins} \times \text{Bin Width}) + (\text{Number of Bins} \times 250 \text{ ns}) + 150 \mu\text{s}$
SYNC/BUSY output is high for T_p after each trigger. When SYNC/BUSY returns low, the next record may be triggered. Triggers received while SYNC/BUSY is high are ignored.

OUTPUTS

DISC Nim level into 50 Ω . Low whenever the signal input exceeds the discriminator level with the correct slope.

SYNC/BUSY TTL level. Rising edge is synchronous with the first time bin of each record. Use this edge to trigger the experiment. Remains high until re-armed for next trigger.

BIN CLK OUTPUT Nim level into 50 Ω . Each transition is a bin boundary. Active only while a record is being acquired. Timing skew relative to the DISC output is less than 2 ns.

TOGGLE TTL level. Indicates whether the next record will be added to or subtracted from the accumulation. (Internal toggle mode)

TEST 50 MHz Nim output into 50 Ω . Use to test counters.

AUX1, AUX2 General purpose analog outputs
Full scale \pm 10 VDC
Resolution 12 bits (5 mV)

Output current rating 10 mA
Output impedance < 1
Accuracy 0.1% + 10 mV

INPUTS

SIGNAL	Analog 50 input.
TRIGGER	10 k input.
BIN CLK INPUT	TTL input. Rising edge triggers next time bin
ACCUMULATOR INHIBIT	TTL input, sampled each trigger. If high, causes the current record to be ignored (not accumulated)
SUBTRACT	TTL input, sampled each trigger. If high, causes the current record to be subtracted from the accumulation (in external toggle mode).

GENERAL

Interfaces	IEEE-488 , RS-232, and Centronics Printer standard. All instrument functions can be controlled and read through the IEEE-488 and RS-232 interfaces.
Hardcopy	Screen dumps to Epson compatible dot matrix or HP LaserJet printers (parallel). Plots to HPGL compatible plotters (serial or IEEE-488).
Disk	3.5" MSDOS compatible format, 720kbyte capacity. Storage of data and setups.
Power	60 Watts, 100/120/220/240 VAC, 50/60 Hz
Dimensions	17"W X 6.25"H X 16.5"L
Weight	30 lbs
Warranty	One year parts and labor on materials and workmanship

SR430 Multichannel Scaler

SR430 Quick Performance Check

Be sure to read the Overview and Operations sections of the manual to familiarize yourself with the instrument.

This setup requires a 1 Hz to 2 kHz TTL trigger source. A simple function generator will suffice.

Hold down the CLR key while turning the unit on. This resets the SR430 to its default state.

Connect the trigger source to the TRIGGER input on the front panel. Set the Trigger Level and Slope in the LEVELS menu appropriately for the trigger source. Use a 5 foot length or longer BNC cable to connect the TEST output on the rear panel to the SIGNAL input on the front panel. Set the Disc Level to -300 mV and the Disc Slope to Falling.

Set the trigger rate to 1 kHz. Press the START key. Data acquisition should begin. The default bin width is 5 ns and the record length is 1k. 1000 records will be accumulated. When the scan is done, press AUTOSCALE to scale the display. The TEST output is a 50 MHz signal so a pulse occurs every 20 ns or every 4 bins. The data should have 1000 counts in every 4th bin.

Use the Mode menu to select different bin widths and records per scan. Records with longer bin widths trigger at lower rates so the trigger rate needs to be lowered to avoid RATE errors. Use the formula for T_{busy} in the Specifications section of the manual to calculate the maximum trigger rate for each bin width and record length. Longer bin widths also require a smaller number of records per scan to avoid overflow. This is because each bin acquires a larger number of counts per trigger.

Bin widths of 40 ns and longer will collect data in every bin. The first bin may have 1 less count per trigger than the other bins. For longer bin widths 163 μ s or longer, the data may vary up to ± 7 counts per bin per trigger. This is due to the jitter in the longer bin widths.

After acquiring data, use the other menus to scale the data, smooth or perform calculations with the data, save and recall data to disk, etc.

COMMAND LIST

LEVELS

TRLV(?) {x}	Set the Trigger Level to $-2.000 \leq x \leq 2.000$ V.
TRSL(?) {i}	Set the Trigger Slope to Positive (0) or Negative (1).
DCLV(?) {x}	Set the Discriminator Level to $-0.3000 \leq x \leq 0.3000$ V.
DCSL(?) {i}	Set the Discriminator Slope to Positive (0) or Negative (1).
AUX1(?) {x}	Set the AUX1 Level to $-10.000 \leq x \leq 10.000$ V.
AUX2(?) {x}	Set the AUX2 Level to $-10.000 \leq x \leq 10.000$ V.

MODE

BCLK(?) {i}	Set the Bin Clock Source to Internal (0) or External (1).
BWTH(?) {i}	Set the internal Bin Width to 5 ns (0) through 10.486 ms (19).
BREC(?) {i}	Set the number of Bins Per Record to 1 i 16 times 1024.
RSCN(?) {i}	Set the number of Records Per Scan to 0 i 65535.
BOFF(?) {i}	Set the Trigger Offset to 0 i 16320 in increments of 16.
ACMD(?) {i}	Set the Accumulate Mode to Add (0), Toggle (1), or External (2).
TCNT(?) {i}	Set the Toggle Count to 1 i 16384.
PTOG(?) {i}	Set the Pause At Toggle mode Off (0) or On (1).
REAC	ReAcquire count data from data acquisition memory.
ROFF(?) {i}	Set the ReAcquire From Offset to 0 i Trigger Offset in increments of 16.

DISPLAY

AUTS	AutoScale the graph. Same as [AUTOSCALE] key.
CRPK	Move the cursor to the on screen peak. Same as [PEAK] key.
BUGP?	Query the Cursor Marker bin number.
CNTR	Translate the graph to center the cursor. Same as [CENTER] key.
LEFT(?) {i}	Set the Left edge of the graph to bin #i.
BOTM(?) {i} {x}	Set the Bottom of the graph to i counts or x value.
HSCL(?) {i}	Set the Horizontal Screen Width to 8 bins (0) through 16k bins (22).
VSCL(?) {i} {x}	Set the Vertical Scale to i counts/division or x/division in a 1-2-5-10 sequence.
CURS(?) {i}	Turn the Cursor Off (0) or On (1).
CURW(?) {i}	Set the Cursor Width to Normal (0), Wide (1), or Spot (2).
CURM(?) {i}	Set the Cursor Seek Mode to Maximum (0), Minimum (1), or Mean (2).
GRID(?) {i}	Turn the Grid Off (0) or On (1).

SETUP

OUTP(?) {i}	Set the Output Interface to RS232 (0) or GPIB (1).
KCLK(?) {i}	Turn the Key Click Off (0) or On (1).
ALRM(?) {i}	Turn the Alarms Off (0) or On (1).
THRS(?) {i}	Set the Hours to 0 i 23.
TMIN(?) {i}	Set the Minutes to 0 i 59.
TSEC(?) {i}	Set the Seconds to 0 i 59.
DMTH(?) {i}	Set the Month to 1 i 12.
DDAY(?) {i}	Set the Day to 1 i 31.
DYRS(?) {i}	Set the Year to 0 i 99.
PLTM(?) {i}	Set the Plotter Mode to RS232 (0) or GPIB (1).
PLTB(?) {i}	Set the Plotter Baud Rate to 300 (0), 1200 (1), 2400 (2), 4800 (3), 9600 (4).
PLTA(?) {i}	Set the Plotter GPIB Address to 0 i 30.
PLTS(?) {i}	Set the Plot Speed to Fast (0) or Slow (1).
PNTR(?) {i}	Set the Trace Pen Number to 1 i 6.
PNGD(?) {i}	Set the Grid Pen Number to 1 i 6.
PNAP(?) {i}	Set the Alphanumeric Pen Number to 1 i 6.
PNCR(?) {i}	Set the Cursor Pen Number to 1 i 6.
PNFT(?) {i}	Set the Fit Pen Number to 1 i 6.
PRNT(?) {i}	Set the Printer Type to Epson (0) or HP (1).

SAVE AND RECALL

FNAM(?) {string}	Set the current File Name to
------------------	------------------------------

SR430 Multichannel Scaler

string.
SVTR Save the Trace Data to the file specified by FNAM.
SVST Save the Settings to the file specified by FNAM.
SVSS Save the System Configuration to the file specified by FNAM.
RCTR Recall the Trace Data from the file specified by FNAM.
RCST Recall the Settings from the file specified by FNAM.
RCSS Recall the System Configuration from the file specified by FNAM.

MATH

SMTH i Smooth the data using 5 pts (0), 11 pts (1), 17 pts (2), 21 pts (3), or 25 pts (4).
FTYP(?) {i} Set the Fit Type to Line (0), Exponential (1), or Gaussian (2).
FITS Start the Fit Calculation.
PARS? i Query Fit Parameter t0 (0), a (1), b (2), or c (3).
LLIM(?) {i} Set the Left Limit of the curve fit region to bin #i where 0 < i < Right Limit.
RLIM(?) {i} Set the Right Limit of the curve fit region to bin #i where Left Limit < i < Last bin in record.
CALC Start a Calculation
ARGT(?) {i} Set the calculation Argument type to Constant (0), or File (1).
ARGM(?) {i} Set the Constant Argument to x.
STAT Start the Statistical Calculations.
SPAR? i Query Statistical Parameter mean (0), deviation (1), area (2), baseline area (3).

PRINT AND PLOT

PRSC Print the screen. Same as [PRINT] key.
PALL Plot the entire screen.
PTRC Plot the trace only.
PCUR Plot the cursor only.

DATA ACQUISITION CONTROL

SSCN Start data acquisition. Same as [START] key.
PAUS Pause a scan in progress. Same as [STOP] key while BUSY.
CLRS Reset the data memory. Same as [STOP] key while DONE.
SCAN? Query the number of records which have been accumulated so far.

DATA TRANSFER

BINA? {i} Read the entire data record in ASCII format. If i included, read only bin #i data.
BINB? Read the entire data record in binary format.

INTERFACE

*RST Reset the unit to its default configurations.
*IDN? Read the SR430 device identification string.
LOCL(?) {i} Set the Local/Remote state to LOCAL (0), REMOTE (1), or LOCAL LOCKOUT (2).

STATUS

*CLS Clear all status registers.
*ESE(?) {i} Set the Standard Status Byte Enable Register to the decimal value i (0-255).
*ESR? {i} Query the value of the Standard Status Byte. If i is included, only bit i is queried.
*SRE(?) {i} Set the Serial Poll Enable Register to the decimal value i (0-255).
*STB? {i} Query the value of the Serial Poll Status Byte. If i is included, only bit i is queried.
*PSC(?) {i} Set the value of the Power-On Status Clear bit to Set (1) or Clear (0).
ERRE(?) {i} Set the Error Status Enable Register to the decimal value i (0-255).
ERRS? {i} Query the value of the Error Status Byte. If i is included, only bit i is queried.
MCSE(?) {i} Set the MCS Status Enable Register to the decimal value i (0-255).
MCSS? {i} Query the value of the MCS Status Byte. If i is included, only bit i is queried.

INSTRUMENT OVERVIEW

SR430 OVERVIEW

The SR430 data acquisition timing is diagrammed below. A trigger starts a record of up to 32,704 time bins (T_1, T_2, \dots, T_N). Each time bin is of equal duration and is programmable from 5 ns to 10 ms. There is no dead time between time bins. During each time bin, signal pulses are counted. At the end of each time bin, the counter data is stored in memory. The memory address is then incremented and the counter is reset for the next time bin. Thus, a record is a list of counter data points corresponding to counts received in successive time bins. Counts which arrive at a bin boundary are not missed but either fall in the bin just ending or in the bin just starting.

The number of bins per record is set in 1k increments from 1k (1024) to 16k (16,384). This represents the maximum number of bins which can be displayed and analyzed at one time. This limitation is due to the data display buffer having a maximum capacity of 16k data points. The data acquisition memory, however, can store up to 32k data points. Up to 32,704 bins may actually be acquired and accumulated, of which, up to 16k bins may be displayed at a time. The Trigger Offset determines how many bins are skipped at the beginning of the total record before data is transferred to the display buffer.

The maximum count rate is 100 MHz or one count every 10 ns. Thus, short bins can only acquire a small number of counts per bin in a single record. For example, if the bin width is 40 ns, then a single

record can only acquire 4 counts per bin maximum ($4 * 10 \text{ ns} = 40 \text{ ns}$). If the bins width is 5 ns, then the maximum number of counts per bin is 1. The maximum count capacity of each bin is 32,767. When the bin width is large and the count rate is high, it is possible to exceed the count capacity of a bin in a single record. In this case, the data will overflow and be stored as the maximum count (32,767).

A single record can capture a transient counting signal if there are enough counts to be statistically significant in a single shot. If the count rate is very low but the signal is repetitive, then multiple records may be accumulated. Accumulation of records means simply taking each new record and adding it to the sum of all previous records on a bin by bin basis, i.e. data from T_1 of each record is summed together, data from T_2 of each record is summed together, etc. Accumulation reduces statistical noise since the accumulated counts in each bin will be larger than the data from a single record. Each bin can accumulate counts up to 32,767. Additional counts will cause an overflow and the data will be stored as 32,767. If this limit is reached, then the bin width should be reduced and the bins per record increased (to keep the same record time). This will divide the bins which overflowed, into 2 or more smaller bins, each capable of 32,767 counts. Thus, more total counts may be accumulated for the same record time.

A scan is an accumulation of a number of records. The number of records in a scan may be programmed from 1 to 65,535.

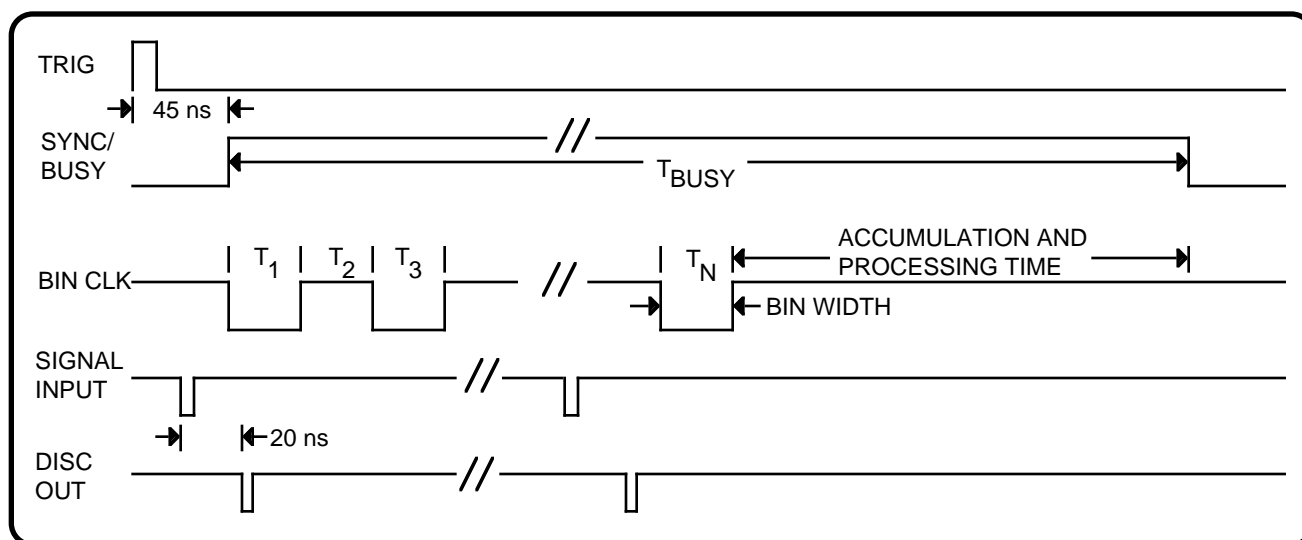

TIMING DIAGRAM

Instrument Overview

TRIGGER and SYNC/BUSY

Data acquisition is started by a trigger. The TRIGGER input is on the front panel. The trigger threshold is adjustable from -2V to +2V and the slope may be either RISE or FALL.

The SYNC/BUSY output is a TTL level signal which serves two purposes. First, it can be used to synchronize the experiment timing with the actual time bins of each record. Second, it indicates when the unit is busy acquiring data and cannot be triggered.

After a trigger is recognized, the SYNC/BUSY output will go high indicating the start of the first time bin. The insertion delay from TRIGGER to SYNC/BUSY is 45 ns. SYNC/BUSY will have 2.5 ns of indeterminacy with respect to the trigger. As a result, the entire record starts with 2.5 ns of uncertainty with respect to the trigger. This is not a problem if the bin width is much longer than 2.5 ns but may be a problem for shorter bin widths. In these cases, the SYNC/BUSY output should be used to trigger the experiment. Since the record is synchronized to SYNC/BUSY, there will be no indeterminacy of the time bins with respect to the experiment. One way to accomplish this is to trigger the SR430 with the experiment's master rate generator and use the SYNC/BUSY (which is delayed from trigger by only 45 ns) to trigger the actual experiment.

After a trigger, the unit is busy acquiring and accumulating data. During this busy time, no new triggers will be recognized. After SYNC/BUSY returns low, a new trigger may occur. The busy time is

$$T_{\text{busy}} = (N \cdot T_{\text{bin}}) + (N \cdot 250 \text{ ns}) + 150 \mu\text{s}$$

where T_{bin} is the bin width (5 ns to 10.5 ms) and N is the number of bins per record (1024 to 32704). The first term is the actual record length and equals the real time duration of the data acquisition. Counts received during the time $N \cdot T_{\text{bin}}$ after the trigger are captured. The second term is the time needed to accumulate the record, i.e. add the data to the sum of all previous data. Accumulation takes 250 ns per bin. The last term is a fixed overhead for processing. For example, if $N=1\text{k}$ bins and $T_{\text{bin}} = 5 \text{ ns}$, then $T_{\text{busy}} = 411 \mu\text{s}$. The maximum trigger rate would then be 2400 Hz. When the bin width is programmed to be much larger than 250 ns, then the busy time is almost totally due to the real time data acquisition and virtually no time is lost processing or accumulating.

SYNC/BUSY is only output during actual data acquisition. Triggers that arrive when the unit is not acquiring data will not cause a SYNC/BUSY output.

BIN CLOCK OUTPUT

The front panel BIN CLK output is a 50 $\frac{1}{2}$, NIM level signal showing the bin boundaries. The first bin, T_1 , is the time period when the BIN CLK is first low following a trigger. Each rising and falling transition of the BIN CLK marks the boundary of a bin. Thus, the second bin, T_2 , is when BIN CLK is next high, T_3 is when BIN CLK is low again, etc.

The first bin starts synchronously with the SYNC/BUSY output. BIN CLK may be used with the DISC OUT signal to determine the exact timing of the counts with respect to the time bins.

BIN CLK is only output during actual data acquisition. Triggers that arrive when the unit is not acquiring data will not cause a BIN CLK output.

EXT BIN CLK INPUT

The front panel EXT BIN CLK input is a TTL input which allows an external source to determine the bin boundaries. When the bin width mode is programmed to EXTERNAL, the EXT BIN CLK will clock the bins. After a trigger, the first rising edge of the EXT BIN CLK will start the first bin. SYNC/BUSY goes high at the same time. Each new rising edge of the EXT BIN CLK will clock the start of a new bin. The maximum external clock rate is 4 MHz or a 250 ns minimum external bin width. The EXT BIN CLK is useful if bins longer than 10.5 ms are required, or when the bins must be synchronized to external events.

SIGNAL INPUT AND DISCRIMINATOR

The analog signal input is labelled SIGNAL INPUT on the front panel. This input is internally terminated into 50 $\frac{1}{2}$. The input can accept signals of either polarity up to $\pm 300 \text{ mV}$ and is protected to $\pm 5 \text{ V}$ dc. The input is followed by a dc to 250 MHz amplifier. This allows detection of pulses as small as 10 mV. If greater sensitivity is required, the SR440 remote pre-amplifier can be used. The SR440 can provide gains from 5 to 125 at bandwidths exceeding 200 MHz.

Following the input amplifier is a discriminator. The discriminator has selectable slope and a threshold programmable from -300 mV to +300 mV in 0.2 mV steps (referred to the inputs). Pulse-pair resolution is 10 ns and pulses of either

polarity may be detected.

The discriminator output is labelled DISC OUT on the front panel. The DISC OUT is a 50 $\frac{1}{2}$, NIM level signal showing the actual input to the counter. The output is active low (-0.7 V) and counting occurs on the falling edge. The output is low when the signal input exceeds the threshold level with the correct slope, i.e. the signal is higher than the threshold with positive slope or the signal is lower than the threshold with negative slope. The DISC outputs are very useful when adjusting discriminator thresholds or determining the exact timing of the counts relative to the time bins.

The DISC OUT is active at all times. Whenever a signal pulse exceeds threshold with the correct slope, a pulse is output at DISC OUT. The unit does not have to be actively acquiring data. This enables setting the discriminator threshold without triggering the unit.

TIMING

The DISC OUT signal is delayed internally by 20 ns so that the DISC OUT and the BIN CLK output are correct relative to each other. In other words, a DISC OUT pulse which falls in the first BIN CLK will be counted in the first bin. However, a DISC OUT pulse is actually due to a signal pulse arriving 20 ns earlier at the SIGNAL INPUT. This means that BIN CLK and DISC OUT, when viewed on a scope using equal length cables terminated into 50 $\frac{1}{2}$, are accurately timed. However, for timing purposes, each output viewed by itself is 20 ns late relative to the trigger. Since the insertion delay for the BIN CLK is 45 ns, signal pulses arriving 25 ns after the trigger will be output at the DISC OUT 45 ns after the trigger and counted in the first bin. For accurate timing, it is best to use DISC OUT and BIN CLK, rather than SIGNAL INPUT and BIN CLK since the latter pair are skewed by 20 ns.

Thus, even though the BIN CLK is output with a 45 ns insertion delay relative to the TRIGGER, the actual insertion delay is 25 ns (20 ns less). Signal pulses arriving 25 ns after the TRIGGER will be counted.

Note that SYNC/BUSY and BIN CLK are only output only during actual data acquisition while the DISC OUT is active all of the time.

DATA ACQUISITION

To begin acquiring data, the number of bins per record and the number of records per scan must be programmed. The record length, N, is the num-

ber of time bins in a single record. Each trigger will take N data points corresponding to N sequential time bins. N may be programmed from 1024 to 32704 (including Trigger Offset).

Records are accumulated until the number of records per scan, R, have been acquired. R may be programmed from 1 to 65536. If R is set to 0 (free run), then accumulation continues without end. This mode is convenient when timing an experiment since BIN CLK and SYNC/BUSY are output only when data is being acquired. When R is 0, every trigger will output SYNC/BUSY and BIN CLK without stopping after a programmed number of triggers.

After the record length and scan length have been programmed, data acquisition can be started. When the [START] key is pressed or a START command is received from the computer interface, data acquisition begins. The next TRIGGER will start the first record and count data will be stored.

Successive triggers will acquire records which are accumulated until the number of records per scan have been taken. During this time, the unit is BUSY and the SYNC/BUSY and BIN CLK outputs are active. After the number of records per scan have been accumulated, data acquisition is halted. The unit is now in the DONE state. Triggers which arrive while the unit is DONE are ignored and SYNC/BUSY and BIN CLK are inactive.

When the data acquisition is DONE, the final accumulated data is displayed on the screen and may be analyzed and manipulated. Before taking data again, the current data must be cleared by pressing the [STOP/RESET] key or sending the RESET command via the computer interface. This will clear the count memory and the display. The unit will now be in the CLEAR state. While in the CLEAR state, the data acquisition setup may be altered. A new record length or bin width may be programmed, etc. The [START] key will start data acquisition once again and put the unit in the BUSY state.

ADD, SUBTRACT, TOGGLE, and INHIBIT

Normally, records are accumulated by summing corresponding bin data from successive records. Records may also be subtracted from the accumulation. The accumulation mode may be set to ADD, SUBTRACT, TOGGLE, or EXTERNAL.

ADD will sum new records to the accumulation. SUBTRACT will subtract new records from the accumulation.

Instrument Overview

TOGGLE will switch between ADD and SUBTRACT every M records where M is programmable. In this mode, the rear panel TOGGLE OUTPUT will be TTL high before the trigger of those records which will be subtracted.

EXTERNAL will subtract records whenever the external SUBTRACT INPUT is TTL high. The SUBTRACT INPUT is sampled at the trigger and will determine whether that record will be added or subtracted.

The rear panel INHIBIT INPUT is used to ignore a record. If INHIBIT is TTL high when the trigger is received, that record is ignored and not accumulated. The record does count towards the number of records accumulated.

AUX 1, AUX 2

The rear panel AUX 1 and AUX 2 outputs are programmable general purpose dc analog outputs. The output voltages may be set from the front panel or computer interface and can range from -10V to +10V. These outputs may be used wherever an external variable dc voltage is required

TEST

The rear panel TEST output is a 50 , NIM level output. The output frequency is 50 MHz and is synchronous with the BIN CLK. The TEST output is used to test that the counter and accumulator are working properly. By connecting the TEST output to the SIGNAL input, a known number of counts can be put into every time bin. This allows the user to quickly check the functionality of the unit.

DISK DRIVE

The 3.5" disk drive is used to save data, setups, and configurations. The format is DOS compatible and the capacity is 720k.

COMPUTER INTERFACES

RS232 and GPIB (IEEE-488) interfaces are standard on the SR430. All settings of the instrument may be controlled via the computer interfaces. Data may also be transmitted to a computer.

PLOTTING

An HPGL compatible plotter may also be connect-

ed directly connected to the RS232 or GPIB interface. Data will be plotted directly from the SR430 without a computer.

PRINTER

A parallel printer port is standard on the SR430. Any EPSON compatible dot matrix graphics printer or HP LaserJet printer may be used. Full screen printouts may be generated by pressing the [PRINT] key on the front panel.

KEYBOARD

An IBM PC compatible keyboard may connected to the keyboard connector. The keyboard must operate in the PC or XT mode. This is often called the 8088 mode. The keyboard may be used to enter data instead of the keypad. This is most useful with disk file names.

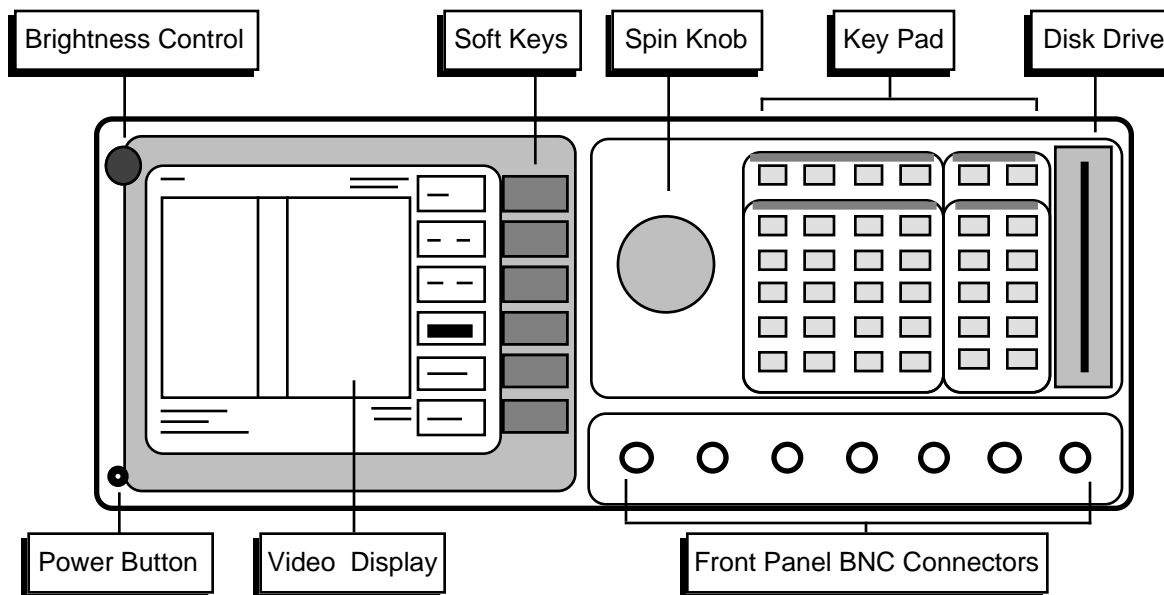

POWER BUTTON

The SR430 is turned on by pushing in the POWER button. The video display may take a few seconds to warm up and become visible. Adjust the brightness until the screen is easily readable. The model, firmware version, and serial number of the unit will be displayed briefly when the power is turned on. The memory status is also displayed. All instrument settings are stored in nonvolatile memory and are retained when the power is turned off. If the memory check passes, then the instrument returns to the settings in effect when the power was last turned off. If there is a memory error, then the stored settings are lost and the default settings are used. To reset the unit into the default state, hold down the [CLR] key while the power is turned on. The default setup is listed in a later chapter.

VIDEO DISPLAY

The monochrome video display is the user interface for data display and front panel programming operations. The resolution of the display is 640H by 480V. The brightness is adjusted using the brightness control knob located at the upper left corner. As with most video displays, do not set the brightness higher than necessary. The display may be adjusted left and right using the Setup Screen function in the SETUP menu.

The main area of the display is occupied by the data display. Data is graphed as accumulated counts per bin on the vertical axis and bin # or time from trigger on the horizontal axis. The graph is continuously updated during data acquisition. When data acquisition is DONE, the total accumulated data is displayed.

A complete description of the screen display follows in the next section.

SOFT KEYS

The SR430 has a menu driven user interface. The 6 soft keys to the right of the video display have different functions depending upon the information displayed in the menu boxes at the right of the video display. In general, the soft keys have two uses. The first is to toggle a feature on and off or to choose between 2 settings. The second is to highlight a parameter which is then changed using the spin knob or numeric keypad. In both cases, the soft keys affect the parameters which are displayed adjacent to them.

Guide To Operation

KEYPAD

The keypad consists of four groups of keys. The ENTRY keys are used to enter numeric parameters which have been highlighted by a soft key. The MENU keys select a menu of soft keys. Pressing a menu key will change the menu boxes which are displayed next to the soft keys. Each menu groups together similar parameters and functions. The CONTROL keys start and stop actual data acquisition, select the cursor and auto-scale the display. These keys are not in a menu since they are used frequently and while displaying any menu. The SYSTEM keys print the screen to a printer and display help messages. Once again, these keys can be accessed from any menu.

A complete description of the keys follows in the next section.

SPIN KNOB

The spin knob is used to adjust parameters which have been highlighted using the soft keys. Any numeric entry field may be adjusted using the knob. In addition, functions such as display zooming and scrolling use the knob as well. In these cases, the knob function is selected by the soft keys. The [CURSOR] key, which can be pressed at any time, will set the knob function to scrolling the cursor.

DISK DRIVE

The 3.5" disk drive is used to store data and instrument settings. Double sided, double density disks should be used. The disk capacity is 720k bytes formatted. The disk format is DOS compatible. Disks written by the SR430 may be read by PC compatible computers equipped with a 3.5" drive and DOS 3.0 or higher.

BNC CONNECTORS

TRIGGER

The rising or falling edge of the TRIGGER input triggers a record. The input impedance is 10 K and the minimum pulse width is 10 ns. The trigger level is adjustable from -2V to +2V with either slope. The minimum pulse amplitude is 100 mV.

SYNC/BUSY

TTL output high whenever the SR430 is acquiring or accumulating a record. Triggers received during this time are ignored. The rising edge of SYNC/BUSY is synchronous with the start of the first bin and may be used to trigger the experiment to remove the 2.5 ns uncertainty between trigger and SYNC/BUSY. This output is active only when the SR430 is in the BUSY state actively accumulating records.

SIGNAL INPUT

The SIGNAL INPUT is a 50 Ω analog input. A photomultiplier or preamplifier output is connected to this input. The input is linear between -300 mV to +300 mV and protected to ± 5 Vdc.

DISC OUT

The DISC output is a 50 Ω , NIM level output is active low (-0.7 V) when the signal input exceeds the threshold level with the correct slope. Counting occurs on the falling edge.

BIN CLK OUT

The BIN CLK output is a 50 Ω , NIM level output showing the position of the time bins. Each transition of this output is a bin boundary. This output is active only when SYNC/BUSY is active.

EXT BIN CLK INPUT

The EXT BIN CLK is a TTL input whose rising edges mark the bin boundaries. The maximum clock rate is 4 MHz. This input is active if the bin width has been programmed to EXTERNAL.

OPTION

This connector is unused.

SCREEN DISPLAY

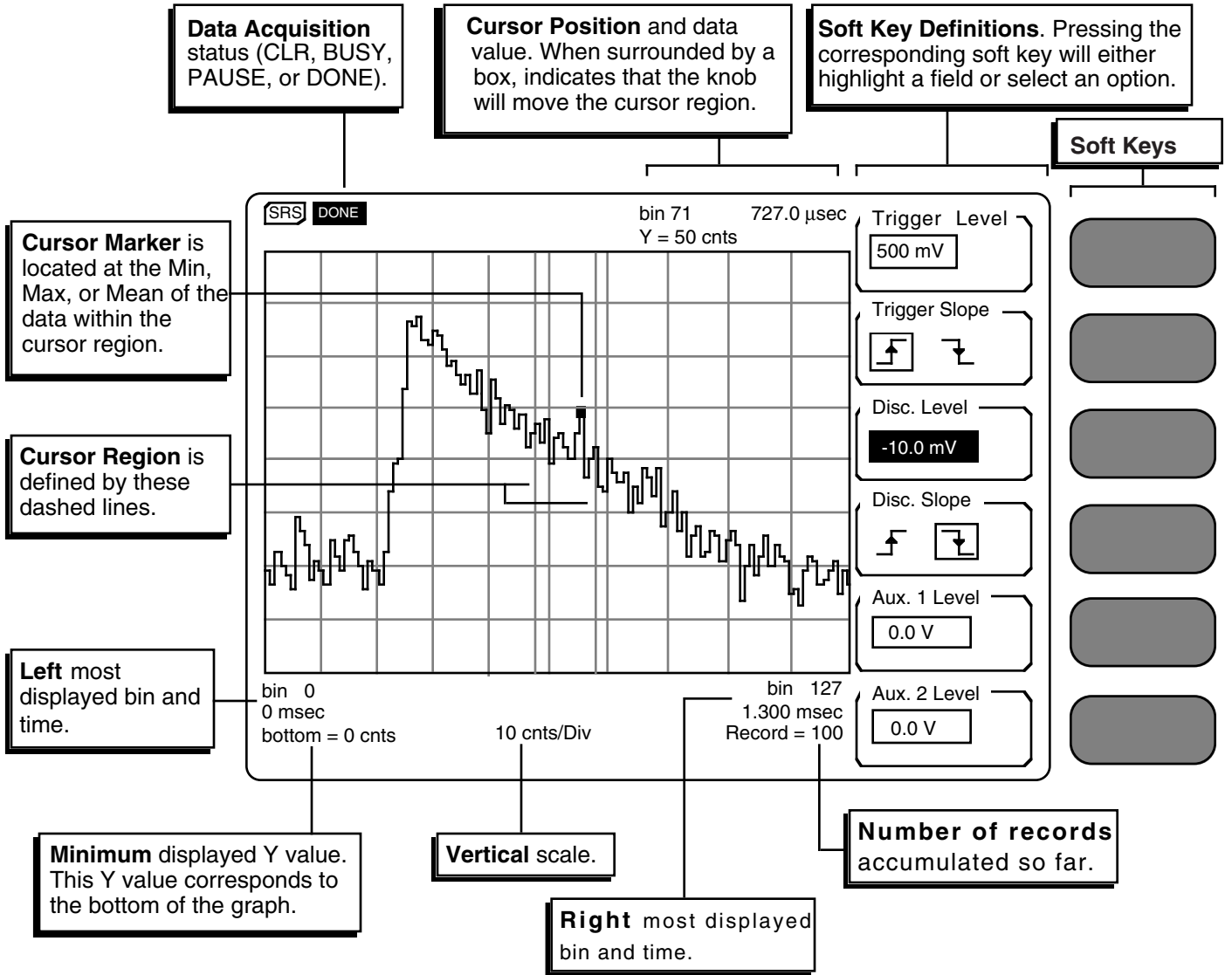

DATA DISPLAY

Data is graphed with accumulated counts per bin on the Y axis and bin number or time on the X axis. The physical size of the graph remains constant while the vertical and horizontal scales may be changed. The graph area has a dotted grid for reference. There are 8 vertical divisions and 10 horizontal divisions. In addition to X and Y scaling, the graph may also be translated in the X and Y directions.

Data is shown in 2 modes depending upon the X scaling. There are 496 pixels or X screen locations

across the graph. If the number of bins displayed is less than the 496, then each data point is shown as a horizontal line at the correct Y position. The graph above shows data in this mode. When the number of bins exceeds 496, then each X screen location on the graph corresponds to multiple bins. The data is then displayed as a vertical line at each X screen location. The displayed line connects the maximum and minimum values of the data points at each X screen location.

The **Left** most displayed bin and time is the X value corresponding to the left edge of the graph.

Guide To Operation

The **Right** most displayed bin and time is the X value of the right edge of the graph. These values represent the X scale and translation. The X scale is (Right-Left)/10 per division. The horizontal scale ranges from 16 bins to N bins across the graph. The actual position of the displayed data within the record is given by the Left and Right values. Bin #0 is the first bin in the record and Bin #N-1 is the last bin where N is the programmed number of bins per record. The Left and Right values mark the region of the record displayed on the graph. The graph may be horizontally translated in increments of 1/100 of the screen or 1 bin, whichever is larger.

The **Vertical** scale is the number of accumulated counts per division displayed on the graph. This value is changed whenever the vertical scale is adjusted. The vertical scale ranges from 1 to 5000 counts per division. The **Minimum** displayed Y value corresponds to the Y value of the bottom edge of the graph. This value is changed whenever the graph is translated up or down. The graph may be translated in the vertical direction in increments of 1/80 of the screen or 1 count, whichever is larger.

The **Number of Records** accumulated is displayed in the bottom right corner. While data is being acquired and accumulated, the graph is being constantly updated to display the data accumulated so far. Each time the data is updated, the number of records is updated. When the scan is complete, the graph will show the total accumulated data and the number of records accumulated will be equal to the programmed number of records per scan. While data acquisition is in progress, the graph shows the data accumulated and the number of records completed.

CURSOR DISPLAY

The **Cursor Region** is the graph region between the vertical dashed lines. The cursor region may be set to 1 division (wide), 1/2 division (norm), or a single vertical line (spot). The cursor region does not change with horizontal scaling. The **Cursor Marker** is a small square which seeks the minimum, maximum, or mean of the data within the cursor region. When seeking min or max, the cursor marker is located at the position of the data point which is the min or max. This allows peaks and valleys in the data to be easily read out. When seeking the mean, the X position of the cursor marker is at the center of the cursor region and the Y position is the mean of the data within the region. When a spot cursor region is used, the cursor marker is confined to a single X screen location. However, depending upon the horizontal

scaling, each X screen location may represent multiple data points. The cursor marker can still seek the min, max, or mean of the data at a single X screen location.

The **Cursor Position** displays the X position (bin # and time) and the Y data of the cursor marker. In the case where each X screen location represents multiple data points, the actual bin# corresponding to the min, max, or mean is displayed. Pressing the [CURSOR] key will draw a box around the cursor information. When the cursor readout is surrounded by a box, the spin knob is to adjust the position of the cursor region. The cursor region moves in increments of one X screen location or pixel.

MENU DISPLAY

The **Soft Key** menu boxes define the functions of the 6 soft keys at the right of the screen. The menu boxes are grouped into menus. Pressing each of the ten menu keys will display a different menu of boxes. Related functions are grouped into a single menu. In general, pressing a soft key does one of two things. One is to toggle between 2 or 3 choices directly. An example is the Trigger Slope box illustrated on the previous page. Pressing the second soft key toggles the slope between rising and falling. The second soft key function is to highlight an entry field and knob function. An example would be the Trigger Level. Pressing the first soft key will highlight the Trigger Level value. The Trigger Level may then be adjusted with the knob or programmed with a value using the numeric entry keys. Each menu is described at length in a following section.

DATA ACQUISITION STATUS

The **Data Acquisition** status is displayed in the upper left corner. The acquisition status is always displayed and is always in inverse video. CLR indicates that the accumulation memory and counters are reset. The data are all zeroes. All parameters can be changed while in the CLR state. Pressing the [START] key will start data acquisition and the status will change to BUSY. While in the BUSY state, data is graphed as it accumulates and parameters related to the data acquisition may not be changed. When the programmed number of records per scan has accumulated, then data acquisition is DONE. The graph will show the final accumulation. Acquisition may be paused during BUSY by pressing the [STOP] key. The status is then PAUSE. While in the PAUSE state, the [START] key continues data acquisition and the [STOP] key will reset to the CLR state. In general, pressing the [STOP] key twice in succession will

reset to the CLR state.

STATUS INDICATORS

In addition to the acquisition status, there are a number of other status indicators which may be displayed. These indicators are visible only when the condition they represent is present. The position of these indicators is fixed, they simply turn on and off. The indicators are shown below.

ALT

Indicates that the ALTERNATE keypad is in use. The ALTERNATE keypad uses the alphabetic legends printed below each key. The [ENTER] key has the same function in the ALTERNATE keypad. To enter the ALT mode, press the [ALT] key once. Pressing the keys will now enter alphabetic characters into the active entry field. To return to the normal keypad, press the [ALT] key again.

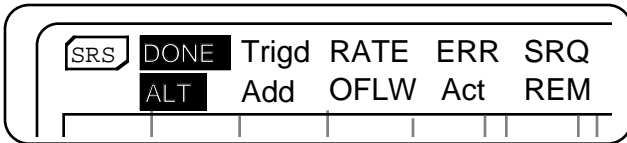

Trigd

Flashes on whenever a record is triggered during data acquisition. Trigd does not flash unless the unit is in the BUSY state (after the [START] key is pressed). Triggers received during other times will not flash this indicator.

Add or Sub

This indicates whether the next record will be added to or subtracted from the accumulation. Sub is may be active if the accumulation mode is set to SUB, TOGGLE, or EXTERNAL.

RATE

This flashes when a trigger is received while SYNC/BUSY is high, i.e. the unit is still acquiring data from a previous trigger. These triggers are ignored and do not contribute to the data accumulation. The extra triggers simply flash the RATE indicator. Only triggers received while SYNC/BUSY is low will trigger a data record.

OFLW

This indicator will turn on during accumulation if any bin accumulates more than 32,767 counts (in ADD accumulate mode) or $\pm 16,384$ counts (in

SUB, TOGGLE, or EXTERNAL accumulate mode). The overflowed bin(s) will stay at the limiting value while non-overflowed bins continue to accumulate normally.

ERR

Flashes whenever there is a computer interface error such as illegal command or out of range parameter is received. This does not flash for a printer or plotter error.

Act

Flashes when there is activity on the computer interfaces. This does not flash for printer or plotter activity.

SRQ

This indicator turns on when a GPIB Service Request is generated by the SR430. SRQ stays on until a serial poll of the SR430 is completed.

REM

This indicator is on when the front panel is locked out by a computer interface. No front panel adjustments may be made. To return the unit to local control (if allowed), press the [HELP] key.

KEYPAD

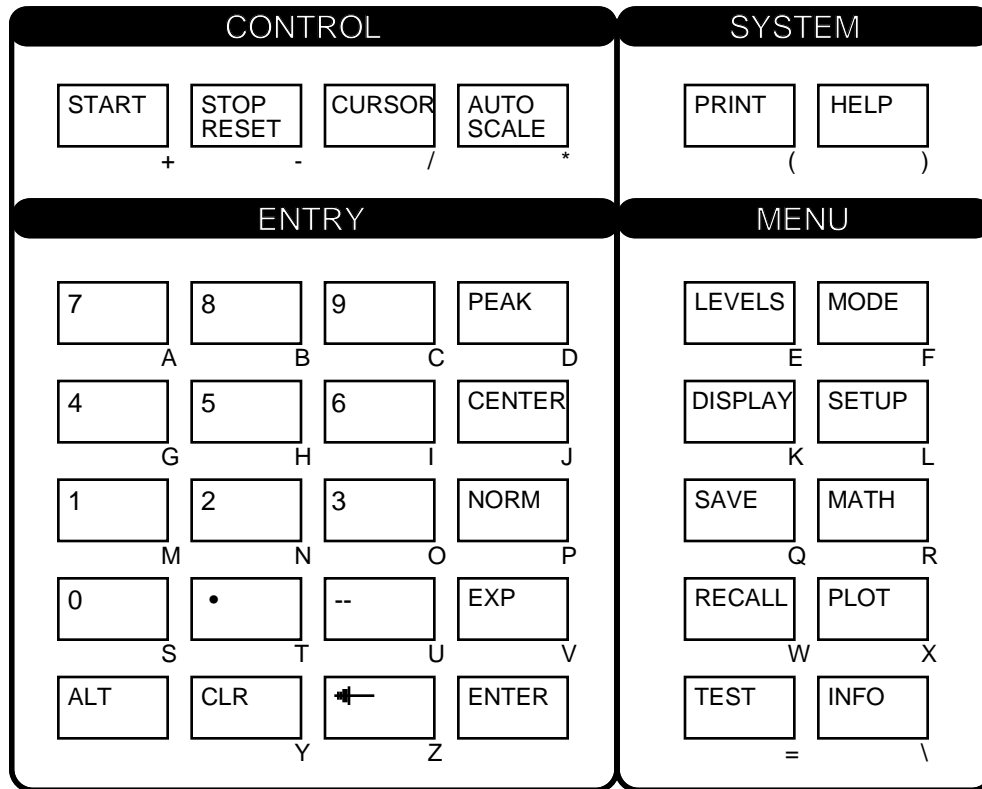

NORMAL AND ALTERNATE KEYS

The normal key definitions are printed on each key. In addition, each key also has an alternate definition printed below it. The [ALT] key toggles the keypad between the two definitions. The ALT screen indicator is on when the alternate definitions are in use. The [ALT] and [ENTER] keys have the same definition in both modes. The alternate keys should only be used when accessing files on the disk drive.

START, STOP, AND RESET

The [START] and [STOP/RESET] keys are used to start, pause, and reset the counter and accumulation memory.

Data acquisition can be started only if the counters and memory are in the CLEAR or reset condition; all data values are zero. The CLEAR condition is indicated by the CLR data acquisition status indicator. Triggers which arrive while in the CLEAR

state are ignored and SYNC/BUSY and BIN CLK OUT are inactive.

[START] begins the data acquisition. The first trigger after [START] is pressed will trigger the first data record. The data acquisition status will switch to BUSY. Successive triggers will acquire records which are accumulated. While the unit is BUSY, the SYNC/BUSY and BIN CLK outputs are active and accumulated data is graphed on the display. Each successful trigger will generate a SYNC/BUSY pulse and a BIN CLK pulse train. Triggers received during SYNC/BUSY active times are ignored. After the programmed number of records have been accumulated, data acquisition is halted. The unit is now in the DONE data acquisition state. The final accumulated data is now graphed on the display. Further triggers will be ignored and SYNC/BUSY and BIN CLK OUT are inactive.

Pressing the [STOP] key while in the BUSY state pauses the data acquisition. The data acquisition status will be PAUSE and no triggers will be recognized. Pressing [START] will continue the data ac-

Guide To Operation

quisition and pressing [STOP] will reset the unit to the CLEAR state.

Pressing [STOP] while in the PAUSE or DONE states will reset the unit to the CLEAR condition. All data accumulated will be lost and reset to zero. In general, pressing the [STOP] key twice in succession will put the unit in the CLEAR condition.

IMPORTANT NOTE: Data which is cleared cannot be recovered! Be sure to save valuable data to the disk to avoid accidentally erasing it.

MENU KEYS

All operating parameters of the SR430 are grouped into ten function menus. The ten menu keys select which menu of parameters is displayed next to the six soft keys. The soft keys then either toggle a parameter, highlight a parameter entry field (for numeric entry or knob adjustment), or display a submenu.

The [LEVELS] menu displays the trigger, discriminator, and auxiliary D/A levels. The [MODE] menu displays the bin width, bins per record, records per scan, accumulation mode, and trigger offset. The [DISPLAY] menu shows graph translation and zoom and the cursor modes. The [SETUP] menu configures the computer interfaces, sound, real time clock, plotter, and printer. The [SAVE] and [RECALL] menus are the disk menus. Data, settings ([LEVELS] and [MODE]), and system setups may be saved and recalled from disk. The [MATH] menu analyzes and manipulates data. Smoothing, curve fitting, statistical analysis, and calculations may be performed on the data. The [PLOT] menu is used to plot the data graph on a plotter. The [TEST] menu allows the user to test the keypad, external keyboard, knob, RS232 interface, printer interface, disk drive, video screen, and memory. The [INFO] menu displays various information screens.

Detailed descriptions of each menu are provided in the next section.

ENTRY KEYS

The numeric entry keys are used to enter parameter values directly. Parameters may be entered only if their menu box is displayed and their entry field is highlighted. For example, if the LEVELS menu is displayed, the first soft key is next to the Trigger Level box. Pressing the first soft key will highlight the entry field displaying the trigger level. The menu box will appear as illustrated below.

A new trigger level may now be entered using the numeric keys. For example, to set the level to -0.125, press [-] [1] [2] [5] [EXP] [-] [3] or [-] [.] [1] [2] [5] or any combination of keys which evaluates to the correct value. Note that entry is done in units of Volts. The entry field will display the characters as the keys are pressed. If an error is made, the backspace [-] key will erase the last character and [CLR] will restore the field to the original value. When the entry string is correct,

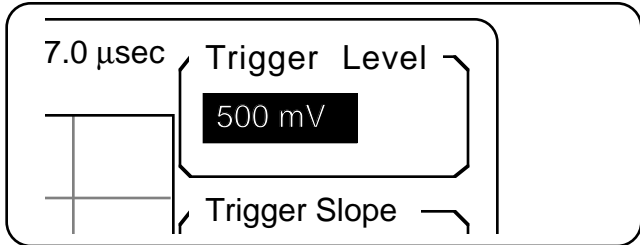

press the [ENTER] key to change the trigger level to the new value. If another soft key is used to highlight a different parameter field or to toggle a setting, or the [CURSOR] key is pressed to highlight the cursor field, or a new menu key is pressed, before [ENTER] is pressed, the displayed entry will be cleared and the original value restored.

Whenever a parameter entry field is highlighted, the knob may also be used to adjust the value. If the knob is turned during numeric entry before the [ENTER] key has been pressed, the value will be adjusted starting from the original value.

CURSOR

Pressing the [CURSOR] key highlights the cursor information field by drawing a box around it. The knob will now scroll the cursor region. The [CURSOR] key highlights the cursor field in the same way that a soft key would highlight a parameter field. The highlighted cursor field appears below.

Any previously highlighted parameter field will become non-highlighted and any entry in progress is cancelled. Pressing a soft key to highlight a parameter field will let the knob adjust the new parameter while the cursor will become de-selected.

AUTOSCALE

Pressing [AUTOSCALE] will automatically set the vertical scale and translation to display the entire range of the data. The graph will also be translated

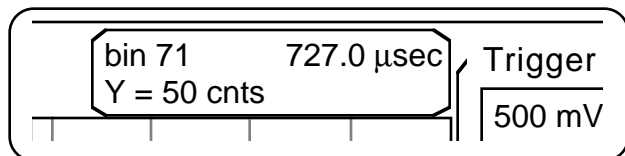

ed so that the it is centered. [AUTOSCALE] does not affect the horizontal scaling or translation. While autoscaling is taking place, the message "AutoScaling" will appear just below the graph. If the number of bins being displayed is very large, the autoscale operation may take a noticeable amount of time.

[AUTOSCALE] may be pressed at any time during or after data acquisition. While the unit is BUSY accumulating and updating the graph, [AUTO-SCALE] may be used to periodically re-scale the graph as the data accumulates beyond the top of the graph.

[AUTOSCALE] only operates on the data which is displayed on the graph. Data corresponding to bins which are not shown do not figure in the auto-scaling calculations.

PEAK

Pressing [PEAK] will center the cursor region around the maximum data value on the screen. The cursor marker will be positioned at the Min, Max, or Mean of the data within the region, depending upon the cursor mode. The [PEAK] key only searches the data which is on the screen. If the maximum value occurs at more than one location, then [PEAK] will find the one closest to the left edge.

CENTER

The [CENTER] key will horizontally translate the graph to place the bin corresponding to the cursor marker at the center of the graph. The horizontal scale is not affected. If the translation can only be accomplished by displaying bins prior to bin #0 or after the last bin, then no action is taken. This can occur when trying to center a bin which is within half of the horizontal scale of either end of the record.

NORM

[NORM] will normalize the entire record of data to the data value of the cursor marker, i.e. all data values are divided by the cursor marker data value. The new value of the cursor marker data is 1.000. The new data will no longer be counts per bin but will simply be floating point numbers. See

the description of the MATH menu for more information about floating point representations of the data. Data may be restored to the original count data using the [REACQUIRE] function in the MODE menu.

[NORM] is useful when measuring relative quantities such as absorption or gain.

PRINT

[PRINT] will print the currently displayed screen to a printer attached to the rear panel parallel printer port. The entire screen, including text and menus, is printed. The time and date will also be printed. The printer type needs to be configured in the SETUP menu before using [PRINT]. A "PrScrn in Progress" message will appear on the screen while printing is in progress. No other front panel operations may be performed until printing is completed. If no printer is attached or there is a printer error, then the print operation is aborted after about 10 seconds. A "PrScrn Aborted" message will appear briefly on the screen.

HELP

[HELP] provides on screen help with any key or soft key. Pressing [HELP] followed by any key will display information about the function or use of that key. [HELP] with a soft key will describe the menu item next to the soft key. Pressing another key will exit the help screen.

The [PRINT] key is the one key for which no help is available. Pressing [PRINT] at any time will print the screen, including the help screens.

LOCAL

When a host computer places the unit in the REMOTE state, no keyboard or knob input is allowed. To return to front panel operation, press the [HELP] key.

REAR PANEL

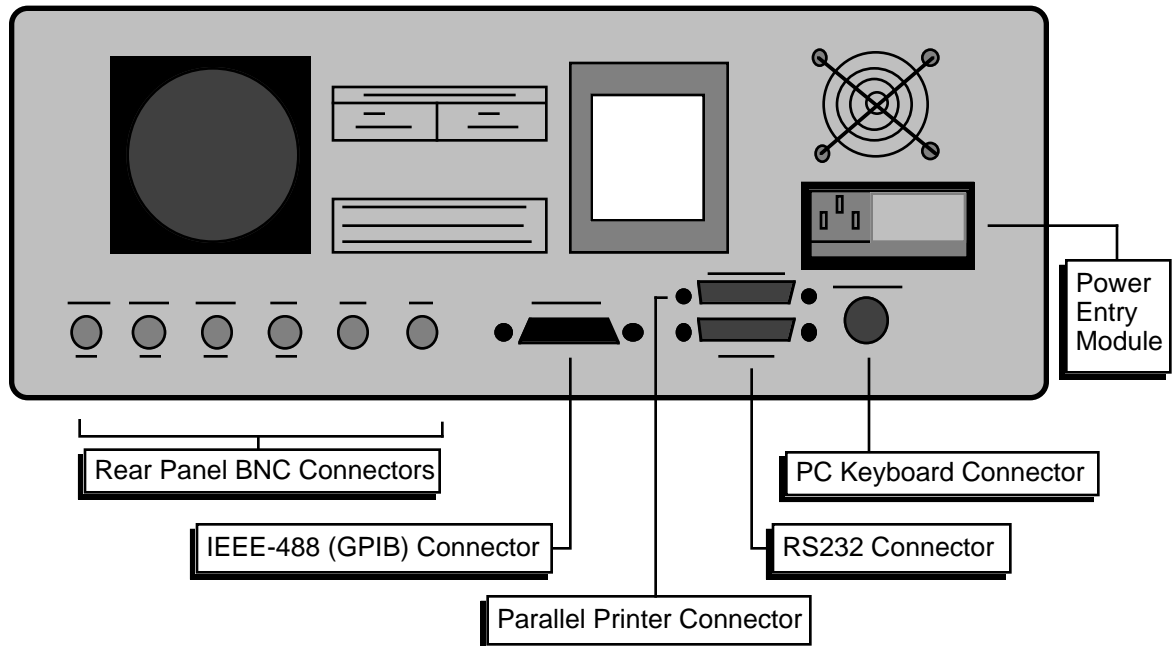

POWER ENTRY MODULE

The power entry module is used to fuse the AC line, select the line voltage, and block high frequency noise from entering or exiting the instrument. Refer to the first page of this manual for instructions on selecting the correct line voltage and fuse.

IEEE-488 CONNECTOR

The 24 pin IEEE-488 connector allows a computer to control the SR430 via the IEEE-488 or GPIB instrument bus. The address of the instrument is set in the SETUP GPIB menu.

Also, a GPIB plotter with HPGL compatible graphics may be connected to the IEEE-488 port. In this case, the SR430 will control the plotter to generate plots of the screen graph. In this case, use the SETUP PLOTTER menu to configure the SR430 to use a GPIB plotter.

RS232 CONNECTOR

The RS232 interface connector is configured as a DCE (transmit on pin 3, receive on pin 2). The baud rate, parity, and word length are programmed from the SETUP RS232 menu. To connect the SR430 to a PC serial adapter, which is usually a DTE, use a straight thru serial cable.

Also, a serial plotter with HPGL compatible graphics may be connected to the RS232 port. The SR430 will drive the plotter to generate plots of the screen graph. Use the SETUP PLOTTER menu to configure the SR430 to use a serial plotter.

PARALLEL PRINTER CONNECTOR

The [PRINT] key will print the screen to an Epson compatible graphics printer or an HP LaserJet compatible laser printer. Use a standard printer cable to attach the printer to the printer port. Use the SETUP PRINTER menu to choose the type of printer.

Guide To Operation

PC KEYBOARD CONNECTOR

An IBM PC or XT compatible keyboard may be attached to the keyboard connector. An AT keyboard may be used if it can be switched to PC or 8088 mode. Typing at the attached keyboard is the same as entering numbers and letters from the front panel keypad. Highlighted parameter entry fields will accept characters from the keyboard. Typing 'E' or 'e' is the same as [EXP]. In general, the keyboard is only useful for alphabetic fields such as file names.

BNC CONNECTORS

INHIBIT INPUT

If the INHIBIT input is TTL high when a trigger is received, then that record of data is ignored and not accumulated. The record will count towards the number of records per scan.

SUBTRACT INPUT

When the accumulate mode is set to EXTERNAL, records which are triggered when the SUBTRACT INPUT is TTL high are subtracted from the accumulation. This input is sampled at the trigger to determine what to do with the ensuing data record.

TOGGLE OUT

The TOGGLE OUT is a TTL signal which indicates

what the accumulation mode of the next record will be. This output is only used if the accumulation mode is set to TOGGLE. TOGGLE switches at the end of the SYNC/BUSY time to reflect the accumulation mode of the next trigger. If TOGGLE is high, then the next record will be subtracted. The state of TOGGLE at the time of the trigger determines the accumulation mode of the data record.

TEST

TEST is a 50 , NIM level output. The output frequency is 50 MHz and is synchronous with the BIN CLK. The TEST signal is used to test the counter and accumulator by putting a known number of counts into each bin. See the Test and Troubleshooting section for further information.

AUX 1 and AUX 2

The AUX outputs are general purpose programmable dc analog outputs. The output voltages may be set from the LEVELS menu. The output range is -10V to +10V and the maximum current output is 10 mA.

LEVELS MENU

Introduction

The Levels menu is used to set the trigger and discriminator settings as well as the Aux output levels.

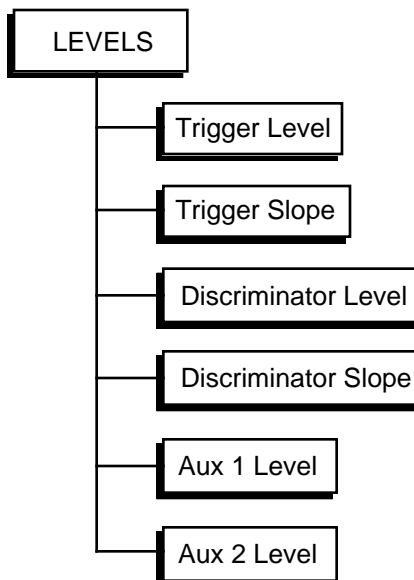
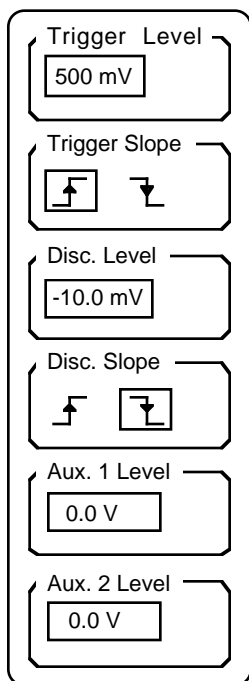

Trigger Level

Pressing the Trigger Level key selects the trigger threshold level as the active entry field. A new trigger level may be entered from the numeric keypad (in units of Volts) or the knob may be used to adjust the present level. The trigger threshold is adjustable from -2.000V to +2.000V with 1mV resolution. The minimum pulse amplitude required to trigger is 0.1V.

Trigger Slope

The Trigger Slope key changes the trigger slope to either rising or falling edge.

Discriminator Level

The Discriminator Level key selects the discriminator threshold as the active entry field. A new threshold level may be entered from the numeric keypad (in units of Volts) or the knob may be used to adjust the level. The discriminator threshold is adjustable from -300mV to +300mV with 0.2mV resolution. The minimum signal pulse amplitude required is 10 mV. The Disc. Out signal is the output of the discriminator. Viewing this signal on an oscilloscope while adjusting the threshold can be helpful in determining the appropriate level. See the "Using Photomultiplier Tubes" section later in this manual.

Discriminator Slope

The Discriminator Slope key changes the discriminator slope to either rising or falling edge. If the input signal pulses are negative going, then the

Levels Menu

slope should be set to falling. If the signal pulses are positive going, then slope should be rising. In either case, the Disc. Output is always active low; i.e., a discriminated rising edge of the signal will be output as a negative going NIM pulse at the Disc. Output. The falling edges of the Disc. Output are counted.

Aux 1 Level

The Aux 1 Level key selects the output level of the AUX 1 output as the active entry field. A new output level may be entered from the numeric keypad (in units of Volts) or the knob may be used to adjust the present level. The output level is adjustable from -10.000V to +10.000V with 5mV resolution.

Aux 2 Level

The Aux 2 Level key selects the output level of the AUX 2 output as the active entry field. A new output level may be entered from the numeric keypad (in units of Volts) or the knob may be used to adjust the present level. The output level is adjustable from -10.000V to +10.000V with 5mV resolution.

MODE MENU

Introduction

The Mode menu sets up the data acquisition parameters, including bin width, accumulation mode, bins per record, and records per scan. With the exception of the Records/Scan and the ReAcquire Offset, these parameters may not be changed unless the unit is in the CLEAR state. ReAcquire may only be performed when data acquisition is done.

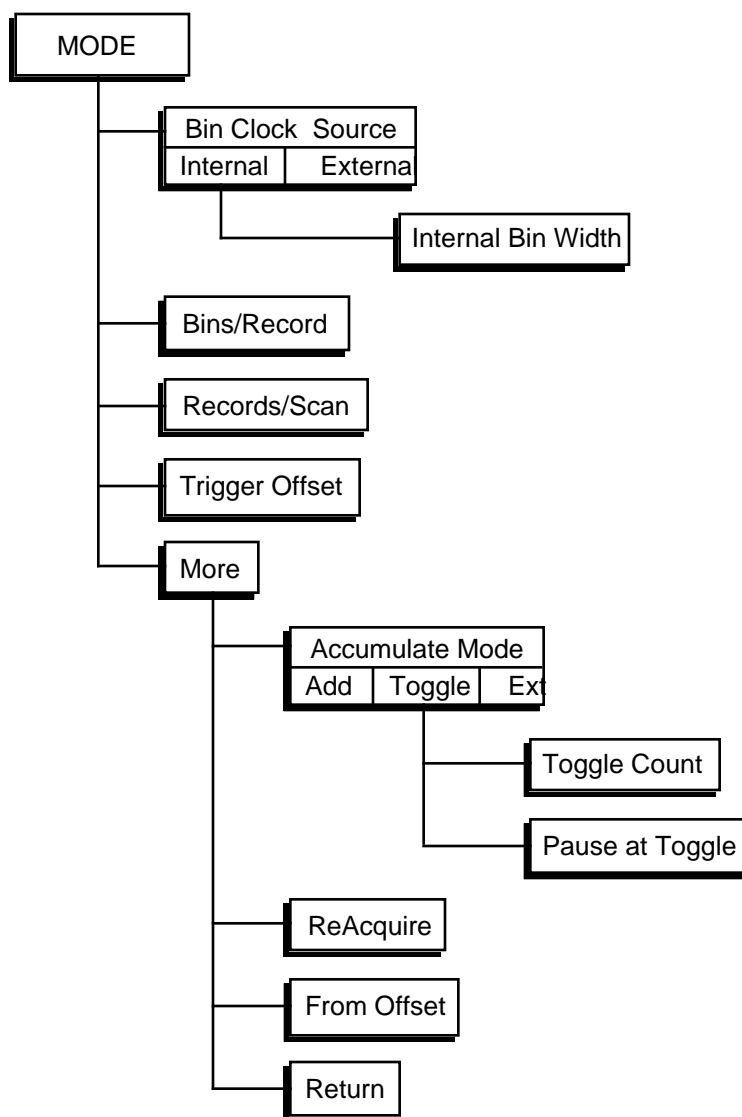
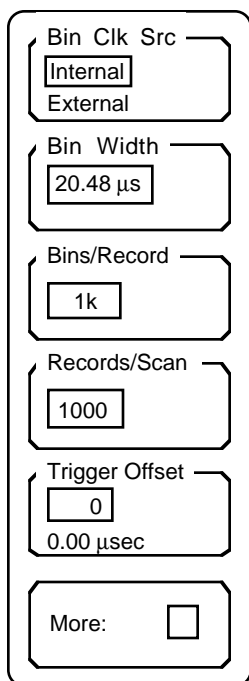

Bin Clock Source

This key toggles the time base of the time bins from internal clock to external bin clock. When set to External, the EXT BIN CLK input determines the width of each bin.

Mode Menu

Bin Width

This key is activated only when the Bin Clock Source is Internal. Pressing this key will activate the internal bin width entry field. The bin width may only be adjusted using the knob. The available bin widths are 5ns, 40ns, 80ns, 160 ns, ... , 10.486ms. 10ns and 20ns bins are not available.

Bins/Record

The Bins/Record key allows the knob to change the number of bins per record. Numeric entry is not allowed in this field. The number of bins per record is set in 1k (1024) increments from 1k (1024) to 16k (16,384). This represents the maximum number of bins which can be displayed and analyzed at one time. This limitation is due to the data display buffer having a maximum capacity of 16k data points. The data acquisition memory, however, can store up to 32,704 data points. Up to 32,704 bins may actually be acquired and accumulated, of which, up to 16k bins may be displayed at one time. The Trigger Offset determines how many bins are skipped at the beginning of the total record before data is transferred to the display buffer. A simple memory map is shown below.

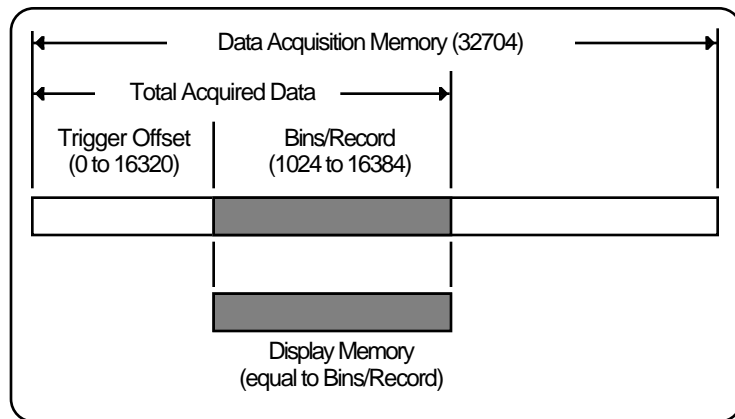

Records/Scan

This key activates the Records per Scan entry field. Both numeric entry and knob adjustment are allowed. The Records/Scan is the number of records which will be accumulated before the data acquisition is DONE. The Records/Scan may be programmed from 0 to 65,535. When set to 0, accumulation will continue indefinitely until the [STOP] key is pressed. This mode of operation is useful when setting up an experiment since the BIN CLK OUT and SYNC/BUSY out will both be active indefinitely instead of only until the scan is DONE.

The Records/Scan may be changed while data acquisition is in progress. If the new value is less than the present number of records accumulated, the scan will finish with the next record. If the new value is greater, then accumulation progresses normally until the new number of records has been acquired.

Trigger Offset

The Trigger Offset determines how many bins are skipped at the beginning of the total record before data is transferred to the display buffer. Up to 32,704 bins may actually be acquired and accumulated, but only a maximum of 16k bins may be displayed at one time. The actual number of bins which are stored in the data acquisition memory is equal to Trigger Offset plus Bins/Record with a maximum of 32,704.

The Trigger Offset entry field accepts numeric entry or knob adjustments. The resolution is 16 bins and the limit is 16,320 bins. Below the entry field, the actual time corresponding to the trigger offset is displayed. This is simply the Trigger Offset (in bins) multiplied by the bin width.

The Trigger Offset is used when the data of interest occurs long after the trigger and short bin widths are required for resolution.

More

The More key displays the second Mode menu. This menu sets the accumulation mode and also reacquires displayed data from the data acquisition memory.

The 'More' menu is a vertical stack of six control boxes. The first box is titled 'Accumulate' and contains three options: 'Add' with a 'Toggle' button, and 'Ext'. The second box is titled 'Toggle Cnt.' and contains a numeric input field with the value '1'. The third box is titled 'Pause at Toggle' and contains two radio buttons, 'Yes' and 'No', with 'No' selected. The fourth box is titled 'ReAcquire:' and contains an unchecked checkbox. The fifth box is titled 'From Offset' and contains a numeric input field with the value '0' and the text '0.00 μsec' below it. The sixth box is titled 'Return:' and contains an unchecked checkbox.

Accumulate Mode

The Accumulate key selects the accumulation mode. ADD mode sums new record data to the accumulation. The maximum accumulation per bin is 32,767. EXT and TOGGLE can either add to or subtract from the accumulation. When either of these modes is selected, the maximum accumulation per bin is $\pm 16,383$.

EXTERNAL mode means that the SUBTRACT input will determine whether each record is added or subtracted. If SUBTRACT is high when a record is triggered, then that record's data is subtracted from the accumulation.

TOGGLE mode will switch between ADD and SUBTRACT after every Toggle Count number of records. In this mode, the TOGGLE output will be TTL high when the next record is to be subtracted and TTL low when the next record is to be added. The TOGGLE output switches at the end of SYNC/BUSY to reflect the accumulate mode of the next triggered record. When data acquisition is started, the first toggle count number of records is added before switching to subtract. The Add/Sub status indicator on the screen shows the toggle status during a scan. Toggle is generally used for background subtraction.

Mode Menu

Toggle Count

This key is active only if the Accumulate Mode is set to Toggle. The Toggle Count is the number of records accumulated in one mode (add or subtract) before switching to the opposite mode. For example, if the Toggle Count equals 4, then the first 4 records are added, the next 4 records are subtracted, the next 4 are added, etc. , until the scan is complete. In general, the Toggle count should be set so that a complete scan has an equal number of records added and subtracted. If the Toggle Count is greater than the Records/Scan, then all records will be added but the maximum accumulation per bin will still be 16,383.

Pause at Toggle

This key is active only if the Accumulate Mode is set to Toggle. If Yes is selected, then data acquisition pauses whenever the accumulate mode toggles between add and subtract. This is useful if the experiment takes time to change modes. Use the [START] key to continue data acquisition. If No is selected, data acquisition runs without pause until the scan is completed.

ReAcquire

The ReAcquire key will restore the display buffer with data from the data acquisition memory. The total accumulated record of data is always available in the data acquisition memory while in the DONE state. When the [STOP/RESET] key is used to reset to the CLEAR state, all accumulated data is lost.

The number of bins transferred to the display memory for graphing and analysis is equal to the Bins/Record. This data may be changed using the MATH menu functions. For example, the data may be squared, multiplied by a constant, normalized, etc. These operations alter the data in the display memory. The ReAcquire function will restore the display memory to the original count data stored in the data acquisition memory.

From Offset

The ReAcquire function re-reads data from the data acquisition memory into the display memory. The acquisition memory stores a number of data points equal to the Trigger Offset + Bins/Record while ReAcquire reads only the number of data points equal to the Bins/Record. ReAcquire skips the number of bins specified in the From Offset field at the beginning of the acquisition memory before transferring data to the display memory. A simplified memory map is shown below.

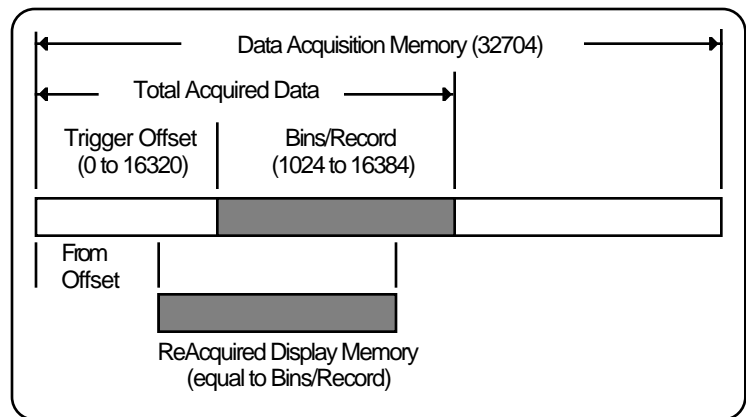

The From Offset value may be set from 0 to the Trigger Offset in increments of 16 bins. The time corresponding to the Offset number of bins is shown below the entry field.

Since the Offset value may be less than the Trigger Offset, bins which were not originally displayed while the data was taken may be displayed using ReAcquire.

Return

The Return key will return to the first Mode menu.

DISPLAY MENU

Introduction

The Display menu is used to change the graph parameters and cursor mode. Note that cursor movement is activated by the [CURSOR] key and not by this menu.

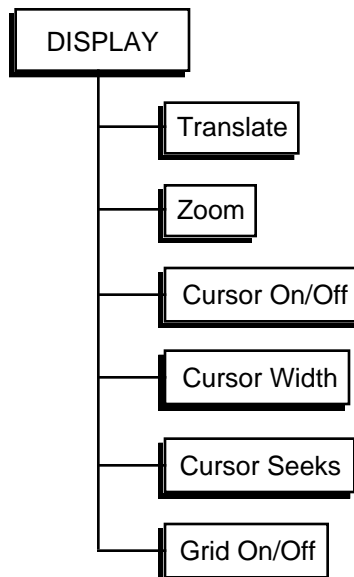
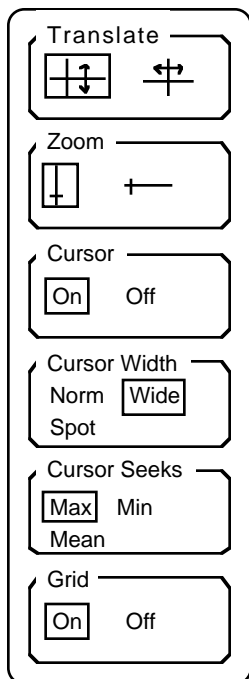

Translate

The Translate key will activate knob control of graph translation in either the vertical or horizontal direction. When the Translate key is pressed, the currently selected direction will become highlighted, and the knob will now translate the graph in that direction. Pressing the Translate key again will toggle to the other axis.

Horizontal translation is in increments of $1/100$ of the screen width rounded up to the nearest integer number of bins. Translation below bin #0 or past the last bin is not allowed. Vertical translation is in increments of $1/10$ of a division or 1 count whichever is larger. If the data is in floating point representation (as a result of a Math function), then translation is in increments of $1/10$ of a division.

Zoom

The Zoom key will activate knob control of graph scaling in either the vertical or horizontal direction. When the Zoom key is pressed, the currently selected direction will become highlighted, and the knob will now expand the graph in that axis. Pressing the Zoom key again will toggle to the other axis.

Vertical scaling is in a 1-2-5-10 sequence starting with 1 count/division

Display Menu

and going up to 5000 counts/division (40000 counts full scale). This allows the full range of count data to be displayed. If the data is in floating point representation (as a result of a Math function), zooming in is limited by the 16 bit resolution of the data. Vertical zooming takes place about the cursor marker (if the cursor is on) or the center of the screen (if the cursor is off).

Horizontal scaling is in powers of 2 from 8 bins up to 1k bins across the screen, and above 1k bins in increments of 1k up to the number Bins/Record (1k to 16k) across the full screen. Horizontal zooming takes place about the cursor marker position unless the cursor is too close to the beginning or end of the record. In this case, zooming will leave the left or right edge of the graph unchanged.

Cursor On/Off

This function turns the cursor region and cursor marker on and off. It is sometimes desirable to turn off the cursor before printing the screen.

Cursor Width

This function selects the width of the cursor region defined by the vertical dashed lines on the graph.

Normal width is 1/2 of a division, Wide is 1 division, and Spot is a single X position on the screen (the cursor marker is a single dashed line).

The cursor region moves to the left and to the right a single pixel at a time. There are 496 pixels across the graph.

Cursor Seeks

The cursor marker searches the data points within the cursor region for the maximum or minimum data value, or calculates the mean of the region. This key toggles between Max, Min, and Mean.

When seeking minimum or maximum, the cursor marker is located at the minimum or maximum data point. This allows peaks and valleys in the data to be read easily. When seeking mean, the X position of the cursor marker is the center of the cursor region and the Y position is the mean of the data within the region. When a spot cursor region is used, the cursor marker is confined to a single X screen location. However, depending upon the horizontal scaling, each X screen location may represent multiple data points. The cursor marker can still seek the minimum, maximum, or mean of the data at a single X screen location.

Grid On/Off

This function turns the grid display on and off. The grid is the set of dotted lines on the graph which mark each scale division.

SETUP MENU

Introduction

The Setup menu is used to configure the printer, plotter and computer interfaces, and set the sound and clock/calendar parameters.

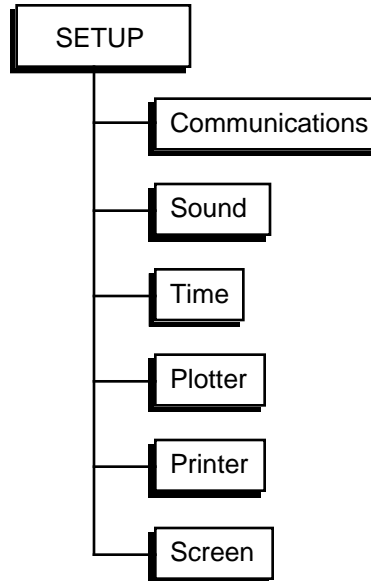
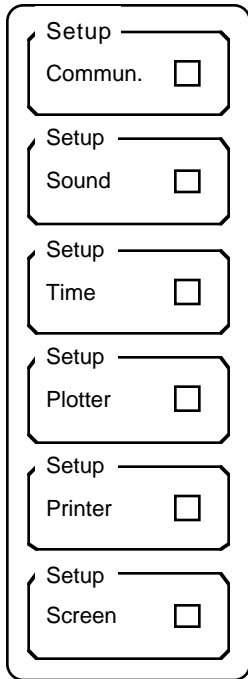

Setup Keys

Each Setup Key activates a sub menu. Each sub menu is described in detail in the following pages.

Setup Menu

Setup Communications

Communication parameters in this sub menu should not be altered while the computer interface is active.

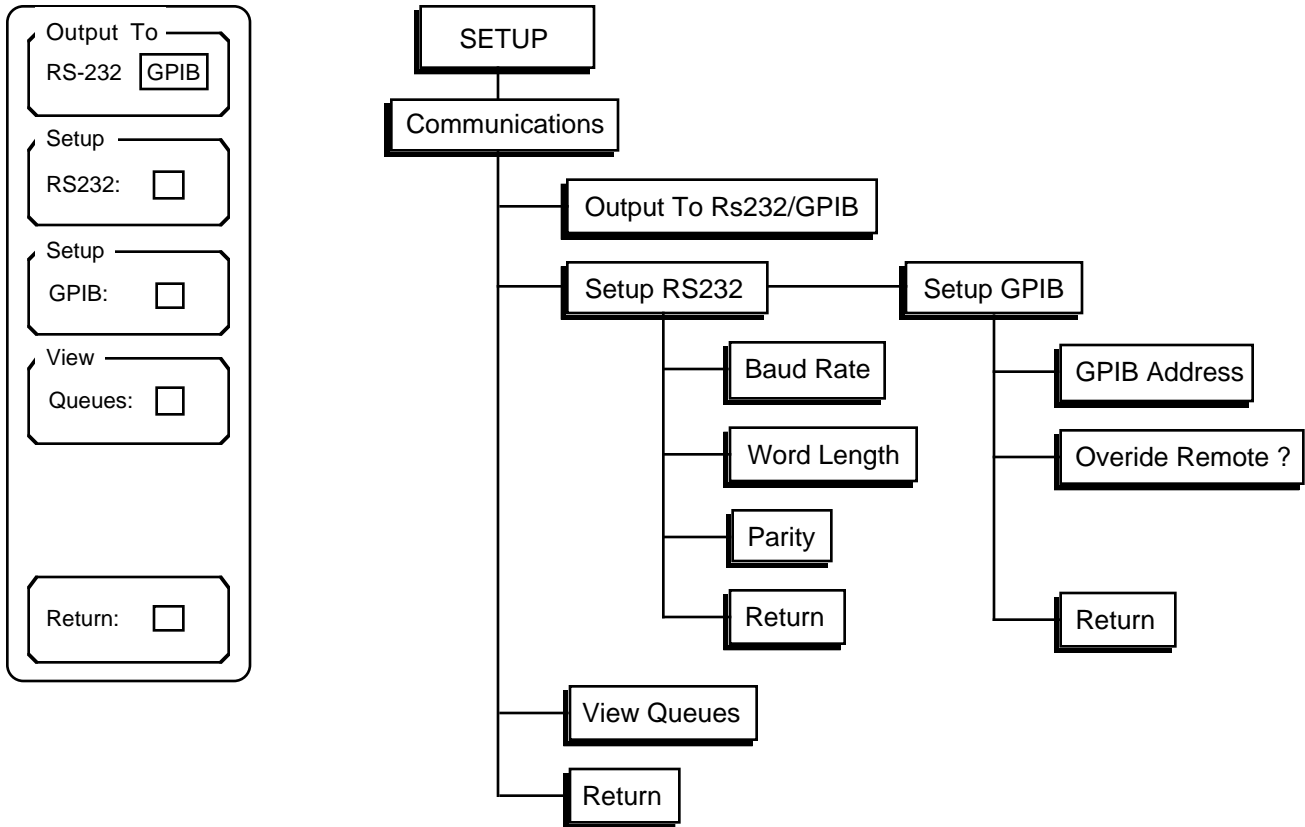

Output To RS232/GPIB

The SR430 only outputs data to one interface at a time. Commands may be received over both interfaces but responses are directed only to the interface selected by the Output To key. Make sure that the Output interface is set correctly before attempting to program the SR430 from a computer.

Setup RS232

The Setup RS232 key activates the RS232 parameters sub menu. Baud rate, word length, and parity may be configured in this sub menu.

The screenshot shows a vertical menu with four sections. The first section is 'Baud Rate' with a knob set to '9600 bd'. The second section is 'Word Length' with two buttons: '7 bits' and '8 bits', where '8 bits' is selected. The third section is 'Parity' with three buttons: 'Even', 'Odd', and 'None', where 'None' is selected. The fourth section is 'Return' with a single button labeled 'Return:' and a square icon.

Baud Rate The Baud Rate key allows the knob to adjust the RS232 baud rate. The baud rate can be set to any standard value from 300 to 19200 baud.

Word Length This key toggles the character length. The RS232 character length can be 7 or 8 bits. 8 bits is standard.

Parity This key toggles the parity. The RS232 parity can be Even, Odd, or None.

Return The Return key will return to the Setup Communications menu.

Setup GPIB

The Setup GPIB key activates the GPIB parameters sub menu. GPIB instrument address and Remote Override are set in this sub menu.

The screenshot shows a vertical menu with two sections. The first section is 'GPIB Address' with a knob set to '8'. The second section is 'Override Remote?' with two buttons: 'Yes' and 'No', where 'No' is selected. The third section is 'Return' with a single button labeled 'Return:' and a square icon.

GPIB Address This key activates the GPIB Address entry field for numeric and knob entry. The instrument address can be set from 0 to 30.

Override Remote ? In general, every GPIB interface command will put the SR430 into the REMOTE state with the front panel inactivated. To defeat this feature, set the Override Remote ? to Yes. In this mode, no GPIB remote enable will put the unit into REMOTE state.

If the SR430 is in the REMOTE state, the [HELP] key returns the unit to local front panel control.

Return The Return key will return to the Setup Communications menu.

Setup Menu

View Queues

The last 256 characters received or transmitted by the SR430 may be displayed to help find programming errors. The View Queues key will display the interface buffers as they are when the key is pressed. This screen is updated regularly to display new interface activity. The View Queues screen may slow down the communications between the SR430 and a host computer. In general, the View Queues screen should be displayed only when testing or debugging a host program.

The most recent data is displayed at the right of the upper line of each queue display. For example, in the screen below, the DCLV?[lf] string was the most recently received command. The [lf] character is a line-feed and is the string delimiter. The most recently transmitted string is .010000[lf] in response to the DCLV? command. The earliest command received was *IDN? and the earliest response was "Stanford Research Systems,SR430,s/n00001,ver007"[lf]. Unrecognized characters are ignored and not displayed. The terminator character on the output queue is always shown as a [lf]. When the output is directed to the RS232 interface, a carriage return [cr] is actually sent in place of the [lf].

Press any key (except [PRINT]) to restore the screen to the graph mode.

Return

The Return key will return to the main Setup menu.

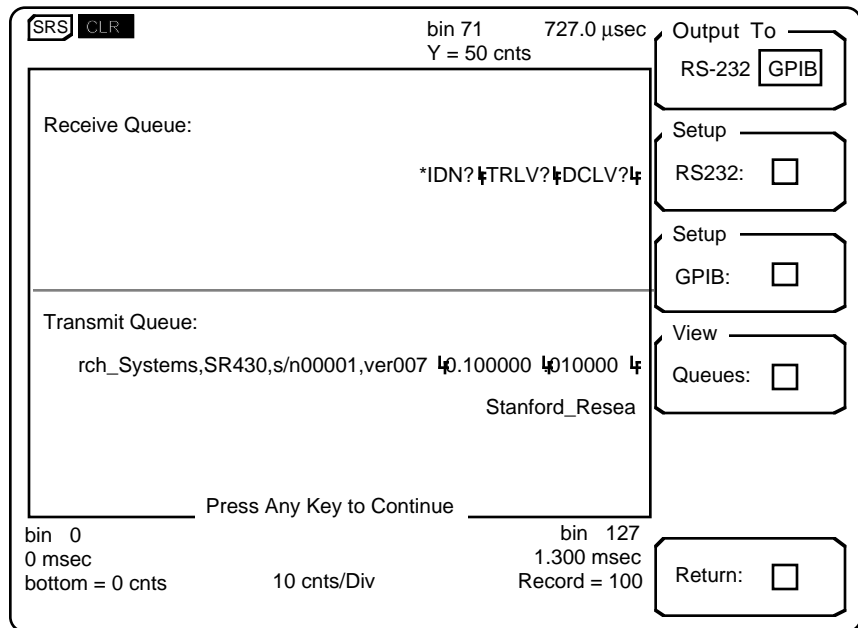

Setup Sound

The Setup Sound key activates the sound sub menu. Key click and alarms are enabled and disabled in this sub menu.

The screenshot shows a vertical rectangular menu with three main sections. The top section is titled "Key Click" and contains two radio buttons, "On" and "Off", with "On" selected. The middle section is titled "Alarms" and also contains two radio buttons, "On" and "Off", with "On" selected. The bottom section is titled "Return:" and contains a single square button.

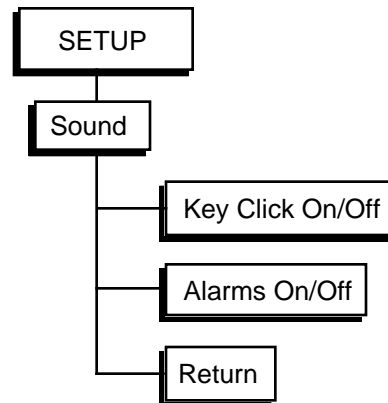

Key Click

This key turns the key click on and off.

Alarms

This key enables and disables the audible alarms. Alarms will sound whenever a front panel programming error or interface error occurs. Alarms are also used to draw the user's attention to a message.

Return

The Return key will return to the main Setup menu.

Setup Menu

Setup Time

The Setup Time key activates the clock/calendar sub menu. The time and date are used to label all screen prints and plots as well as disk files. This menu is used to check or change the time and date.

The screenshot shows a vertical menu with three main sections. The top section is labeled 'Time' and contains a field with the value '09:10:23'. The middle section is labeled 'Date' and contains a field with the value '10/31/89'. The bottom section is labeled 'Return:' and contains a small square button.

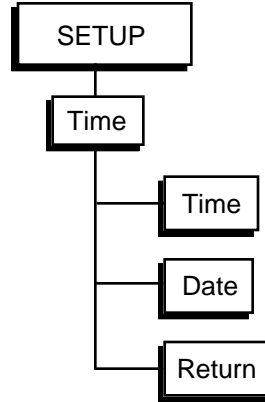

Time

The time is displayed as hours:minutes:seconds. A 24 hour format is used. The time displayed is the time when the Setup Time menu was displayed and does not advance until the menu is redrawn. This key toggles the entry field from hours to minutes to seconds. A new entry may be made using the knob. When the knob is used, the clock is set whenever the highlighted value is changed.

Date

The date is displayed as month:day:year. The date displayed is the date when the Setup Time menu was displayed and does not advance until the menu is redrawn. This key toggles the entry field from months to days to years. A new entry may be made using the knob. When the knob is used, the calendar is set whenever the highlighted value is changed.

Return

The Return key will return to the main Setup menu.

Setup Plotter

The Setup Plotter sub menu configures the SR430 plotter driver. Interface, plot speed, and pen definitions are set in this sub menu. To actually start plotting, use the [PLOT] key to select the Plot menu.

Plot Mode —

RS-232 GPIB

Baud Rate —

Plot Speed —

Fast Slow

Define —

Pens:

Return:

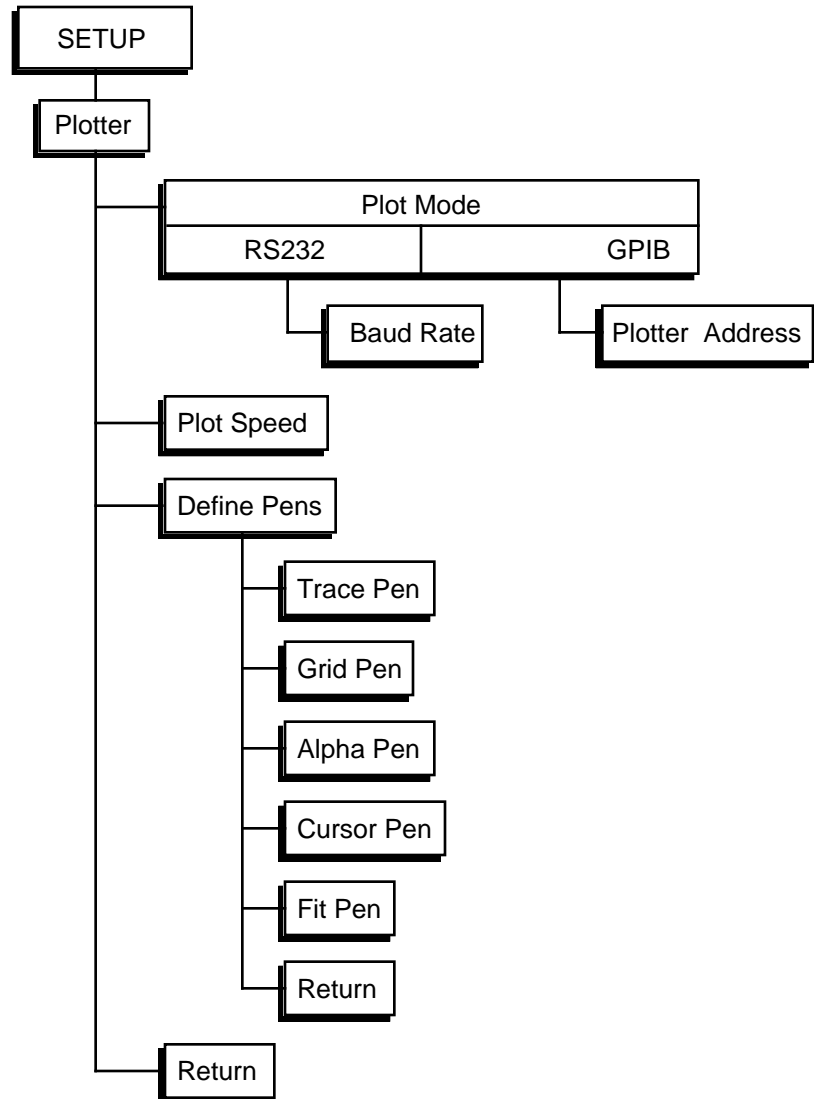

Plot Mode

The SR430 can drive either an RS232 or GPIB interface plotter. The plotter must be HP-GL compatible. This function selects which interface to use. The plotter connects to the RS232 or GPIB connector on the rear panel.

Baud Rate —

Baud Rate

If the Plot Mode is RS232, then the Baud Rate for the plotter may be selected. The baud rate is adjusted using the knob and must match the baud rate of the plotter.

Plotter Addr.

If the Plot Mode is GPIB, then the Plotter Address must be set. The Plot-

Setup Menu

Plotter Addr.

ter Address may be entered from the keypad or by using the knob. The Plotter Address must agree with the address of the plotter in use.

Plot Speed

This key toggles the Plot Speed. Normally, when plotting on paper, the Fast Plot Speed is used. When plotting on transparencies or other non-standard media, the Slow plot speed may be better.

Define Pens

Many plotters have a multipen carousel. In this case, each part of the screen may be plotted using a different color pen. The Define Pens key activates a sub menu in which each feature of the screen may be assigned a pen number. The allowable pen numbers are from 1 to 6. When using a single pen plotter, all features are plotted using the one pen regardless of the pen definitions.

Trace Pen

Grid Pen

Alpha Pen

Cursor Pen

Fit Pen

Return:

Trace Pen This field assigns a pen number to the data trace on the screen.

Grid Pen This field assigns a pen number to the graph grid.

Alpha Pen This field assigns a pen number to all of the alphanumeric characters on the screen.

Cursor Pen This field assigns a pen number to the dashed cursor region lines and cursor marker.

Fit Pen This field assigns a pen number to any curve fit which may be drawn on the screen.

Return This key returns to the Setup Plotter menu.

Return

The Return key will return to the main Setup menu.

Setup Printer

The Setup Printer menu is used to select the type of printer attached to the parallel printer port. The [PRINT] key prints the screen to the printer.

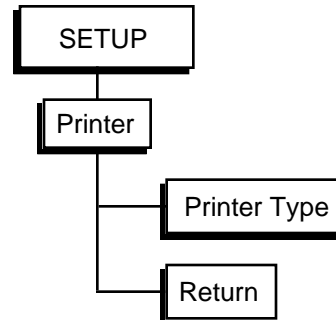

Printer Type

This function toggles the Printer Type between Epson and HP. Epson is used for any Epson compatible graphics dot matrix printer and HP is used for an HP LaserJet laser printer or compatible.

Return

The Return key will return to the main Setup menu.

Setup Menu

Setup Screen

The Setup Screen menu is used to adjust the position of the display on the screen. The display area may be moved left and right.

The image shows a vertical rectangular menu with three distinct sections. The top section is labeled 'Move Right:' and contains a small square checkbox. The middle section is labeled 'Move Left:' and also contains a small square checkbox. The bottom section is labeled 'Return:' and contains a small square checkbox. Each section is enclosed in a rounded rectangular border.

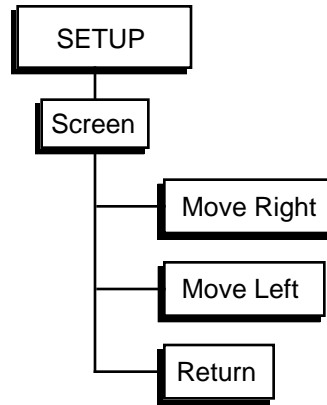

Move Right

This function moves the display to the right on the screen.

Move Left

This function moves the display to the left on the screen.

Return

The Return key will return to the main Setup menu.

SAVE MENU

Introduction

The Save menu is used to save data and parameters to disk. The Disk Utilities menu can erase files and format blank disks. Files are saved as DOS files and can be read by a DOS compatible computer with a 3.5" disk drive. The file format is described in the Remote Programming section.

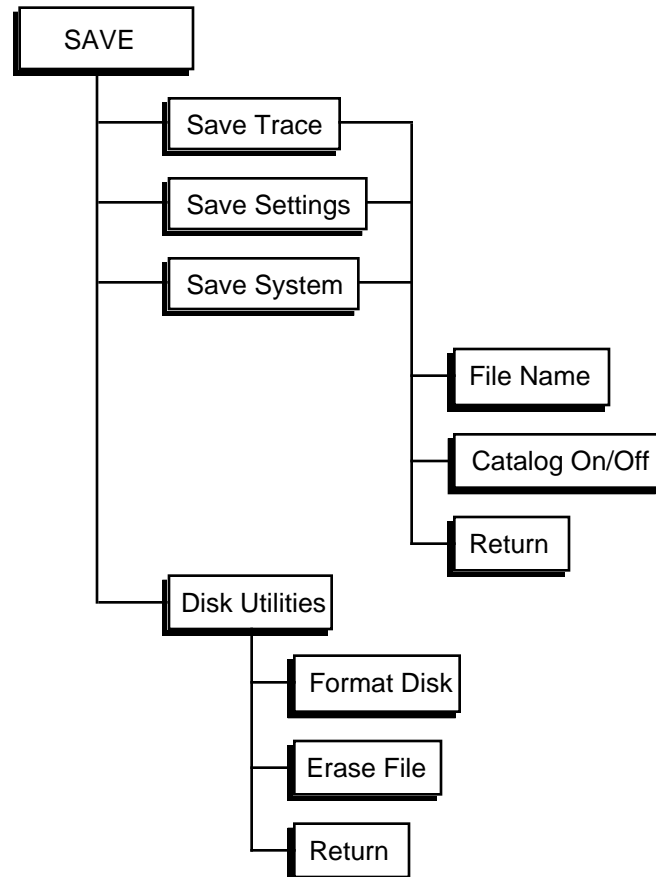
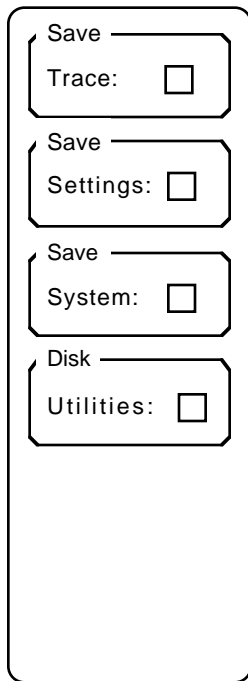

Save Keys

Each Save Key activates a sub menu. The Save Trace, Settings, and System menus are similar.

Save Menu

Save Trace

The Save Trace sub menu is used to save the data record and the graph scaling parameters. The parameters specified in the Mode menu are also saved in the trace file since the data would be meaningless without them.

Save Trace Pressing this key will save the current display memory data and scaling parameters to the file specified in the File Name field.

File Name This key activates the File Name entry field. File names are entered using the keypad and alternate keypad. The [ALT] key allows letters to be entered. DOS file name conventions must be followed, i.e. file names are 8 characters or less with an extension of up to 3 characters. "ABCDEFGH.XYZ" is a valid file name. DOS sub-directories are not supported. All files are saved to the root directory.

Catalog On/Off This key toggles the file catalog display screen on and off. The file catalog display lists all files currently in the root directory. A sample catalog screen is shown below.

The first file will be highlighted and the file name will appear in the File Name field. Activating the cursor by pressing the [CURSOR] key allows the knob to scroll through the directory. The highlighted file name will be copied into the File Name field. If the Save Trace key is now pressed, the data will be saved under an existing file name and the previous version of that file will be lost. A warning message will appear if the File Name is already in use on the disk. To create a new file name, use the File Name key.

Directory entries made by the SR430 also have a type field shown in the catalog display. Files with type SET are settings, type SYS are system, and type TRC are

Name	Type	Size	Date	Time
ABCD		40	06/24/89	15:47:22
TEST	SET	40	08/10/89	10:47:25
SPEC1	DAT TRC	4192	08/10/89	11:08:27
SPEC2	DAT TRC	4192	10/15/89	11:21:01
MYDATA	DAT	4144	10/15/89	11:46:32

Free = 710760

trace data. The file type is not an extension but is information stored in the directory on the disk. Only files created by the SR430 have a type. Files created and saved on a DOS computer will not have a type displayed. The file type is not necessary, it is only an aid to identifying files.

Return The Return key will return to the main Save menu. Return also removes the catalog display screen and restores the graph.

Save Menu

Save Settings

The Save Settings sub menu is used to save the settings in the Levels and Mode menus, i.e. the hardware configuration of the data acquisition system.

The diagram shows a vertical menu with four sections. The top section is labeled 'Save' and contains a 'Settings:' label followed by a square button. The second section is labeled 'File Name' and contains a text input field with 'TEST.DAT' inside. The third section is labeled 'Catalog' and contains two buttons: 'Off' and 'On'. The bottom section is labeled 'Return:' and contains a square button.

Save Settings Pressing this key will save the current settings information (Levels and Mode menu data) to the file specified in the File Name field.

File Name This key activates the File Name entry field. File names are entered using the keypad and alternate keypad. The [ALT] key allows letters to be entered. DOS file name conventions must be followed, i.e. file names are 8 characters or less with an extension of up to 3 characters. "ABCDEFGH.XYZ" is a valid file name. DOS sub-directories are not supported. All files are saved to the root directory.

Catalog On/Off This key toggles the file catalog display screen on and off. The use of this key is identical to the Catalog On/Off function in the Save Trace sub menu above.

Return The Return key will return to the main Save menu. Return also removes the catalog display screen and restores the graph.

Save System

The Save System sub menu is used to save the SR430 system configuration. All parameters in the Setup menu are saved.

The diagram shows a vertical menu with four sections. The top section is labeled 'Save' and contains a 'System:' label followed by a square button. The second section is labeled 'File Name' and contains a text input field with 'TEST.DAT' inside. The third section is labeled 'Catalog' and contains two buttons: 'Off' and 'On'. The bottom section is labeled 'Return:' and contains a square button.

Save System Pressing this key will save the current system information (Setup menu data) to the file specified in the File Name field.

File Name This key activates the File Name entry field. File names are entered using the keypad and alternate keypad. The [ALT] key allows letters to be entered. DOS file name conventions must be followed, i.e. file names are 8 characters or less with an extension of up to 3 characters. "ABCDEFGH.XYZ" is a valid file name. DOS sub-directories are not supported. All files are saved to the root directory.

Catalog On/Off This key toggles the file catalog display screen on and off. The use of this key is identical to the Catalog On/Off function in the Save Trace sub menu above.

Return The Return key will return to the main Save menu. Return also removes the catalog display screen and restores the graph.

Disk Utilities

The Disk Utilities sub menu contains the Format Disk and Erase File functions. **These functions should be used with care since disk data will be erased.** The catalog screen is displayed when in this sub menu.

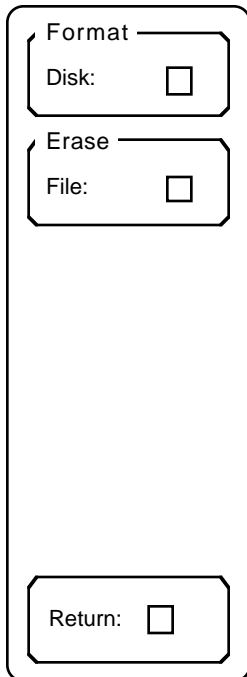

Format Disk Pressing this key will format the disk. Formatting a disk involves erasing all information on the disk and rewriting all the directory. **Formatting a disk destroys all data presently on the disk.** Use caution when choosing this function.

Disk capacity is 720k formatted. The maximum number of directory entries is 112.

Erase File This function will erase the highlighted file. To select a file, activate the cursor with the [CURSOR] key and use the knob to scroll the file entries. Make sure the selected file is the correct file **before** pressing this key.

Return The Return key will return to the main Save menu. Return also removes the catalog display screen and restores the graph.

Save Menu

RECALL MENU

Introduction

The Recall menu is used to recall data and parameters from disk. Files may be recalled only when the unit is in the CLR state (data memory cleared). The Disk Utilities menu can erase files and format blank disks.

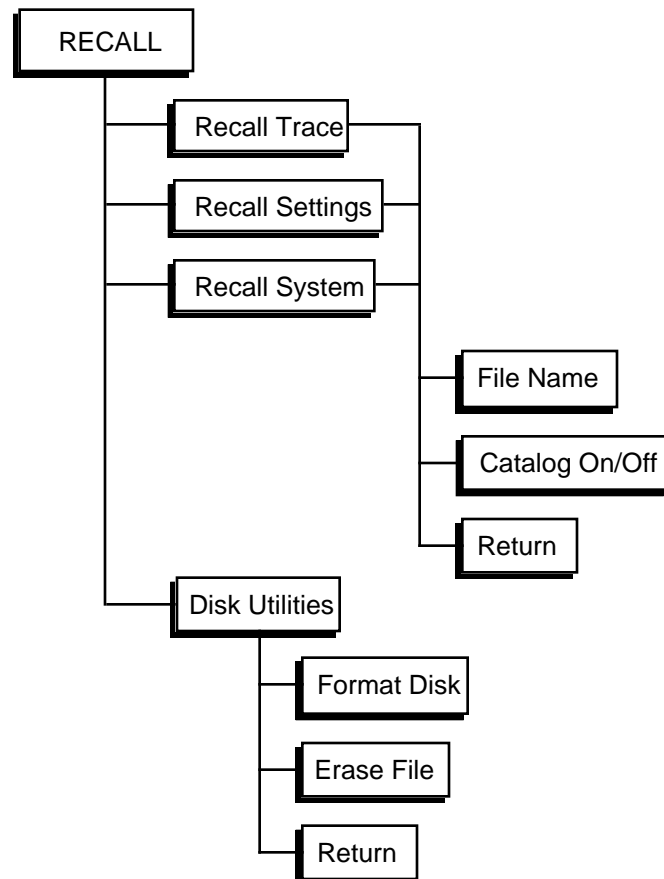
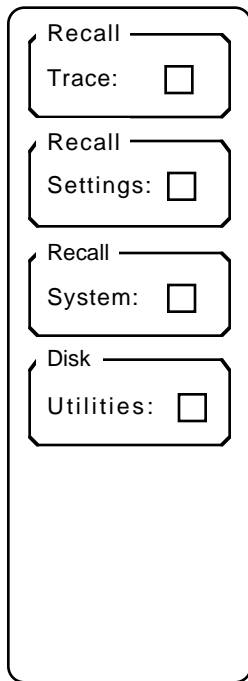

Recall Keys

Each Recall Key activates a sub menu. The Recall Trace, Settings, and System menus are similar.

Recall Menu

Recall Trace

The Recall Trace sub menu is used to read a data record and display from a disk file. Note that the Mode menu parameters and the graph scaling will be set to those corresponding to the disk data. Data may not be recalled unless the unit is in the CLR state (data memory is reset).

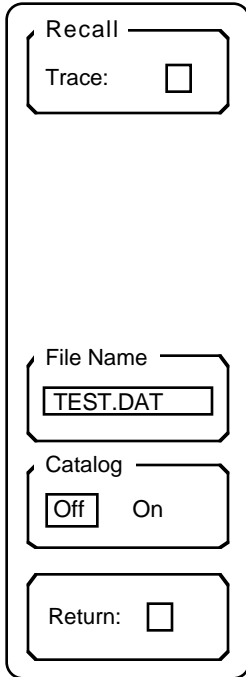

Recall Trace

Pressing this key will recall the data, settings, and scaling parameters from the file specified in the File Name field.

If the file specified is not on disk or is not a trace file, then an error message will appear.

File Name

This key activates the File Name entry field. File names are entered using the keypad and alternate keypad. The [ALT] key allows letters to be entered. DOS file name conventions must be followed, i.e. file names are 8 characters or less with an extension of up to 3 characters. "ABCDEFGH.XYZ" is a valid file name. DOS sub-directories are not supported. All files are read from the root directory.

Catalog On/Off

This key toggles the file catalog display screen on and off. The file catalog display lists all files currently in the root directory. A sample catalog screen is shown below.

The first file will be highlighted and the file name will appear in the File Name field. Activating the cursor by pressing the [CURSOR] key allows the knob to scroll through the directory. The highlighted file name will be copied into the File Name field. If the Recall Trace key is now pressed, the data in the highlighted file will be read.

Directory entries made by the SR430 also have a type field shown in the catalog display. Files with type SET

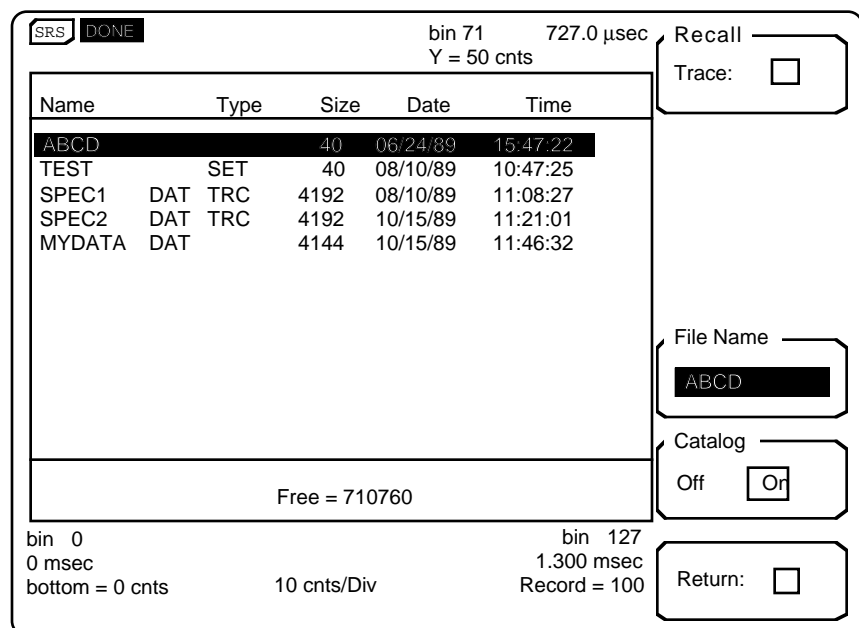

are settings, type SYS are system, and type TRC are trace data. The file type is not an extension but is information stored in the directory on the disk. Only files created by the SR430 have a type. Files created and saved on a DOS computer will not have a type displayed. The file type is not necessary, it is only an aid to identifying files.

Return The Return key will return to the main Recall menu. Return also removes the catalog display screen and restores the graph.

Recall Menu

Recall Settings

The diagram shows a vertical menu with four sections, each enclosed in a rounded rectangle:

- Recall Settings:** Labeled "Recall Settings:" with a small square icon to its right.
- File Name:** Labeled "File Name" above a text input field containing "TEST.DAT".
- Catalog On/Off:** Labeled "Catalog" above a toggle switch with "Off" on the left and "On" on the right.
- Return:** Labeled "Return:" with a small square icon to its right.

The Recall Settings sub menu is used to recall the settings in the Levels and Mode menus, i.e. the hardware configuration of the data acquisition system, from a disk file. Settings may not be recalled unless the unit is in the CLR state (data memory is reset).

Recall Settings Pressing this key will read the settings information (Levels and Mode menu data) from the file specified in the File Name field.

File Name This key activates the File Name entry field. File names are entered using the keypad and alternate keypad. The [ALT] key allows letters to be entered. DOS file name conventions must be followed, i.e. file names are 8 characters or less with an extension of up to 3 characters. "ABCDEFGH.XYZ" is a valid file name. DOS sub-directories are not supported. All files are read from the root directory.

Catalog On/Off This key toggles the file catalog display screen on and off. The use of this key is identical to the Catalog On/Off function in the Recall Trace sub menu above.

Return The Return key will return to the main Recall menu. Return also removes the catalog display screen and restores the graph.

Recall System

The diagram shows a vertical menu with four sections, each enclosed in a rounded rectangle:

- Recall System:** Labeled "Recall System:" with a small square icon to its right.
- File Name:** Labeled "File Name" above a text input field containing "TEST.DAT".
- Catalog On/Off:** Labeled "Catalog" above a toggle switch with "Off" on the left and "On" on the right.
- Return:** Labeled "Return:" with a small square icon to its right.

The Recall System sub menu is used to read the SR430 system configuration from a disk file. All parameters in the Setup menu are read. Recalling System data does not affect any count data presently in memory.

Recall System Pressing this key will read the current system information (Setup menu data) from the file specified in the File Name field.

File Name This key activates the File Name entry field. File names are entered using the keypad and alternate keypad. The [ALT] key allows letters to be entered. DOS file name conventions must be followed, i.e. file names are 8 characters or less with an extension of up to 3 characters. "ABCDEFGH.XYZ" is a valid file name. DOS sub-directories are not supported. All files are read from the root directory.

Catalog On/Off This key toggles the file catalog display screen on and off. The use of this key is identical to the Catalog On/Off function in the Save Trace sub menu above.

Return The Return key will return to the main Recall menu. Return also removes the catalog display screen and restores the graph.

Disk Utilities

The Disk Utilities sub menu contains the Format Disk and Erase File functions. **These functions should be used with care since disk data will be erased.** The catalog screen is displayed when in this sub menu.

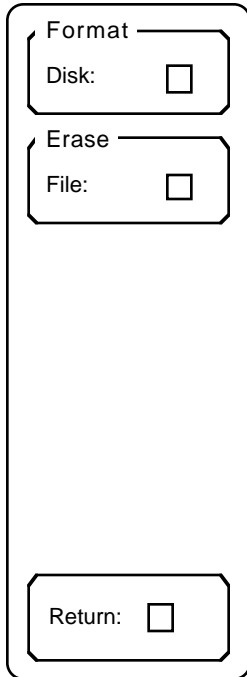

Format Disk Pressing this key will format the disk. Formatting a disk involves erasing all information on the disk and rewriting all the directory. **Formatting a disk destroys all data presently on the disk.** Use caution when choosing this function.

Disk capacity is 720k formatted. The maximum number of directory entries is 112.

Erase File This function will erase the highlighted file. To select a file, activate the cursor with the [CURSOR] key and use the knob to scroll the file entries. Make sure the selected file is the correct file **before** pressing this key.

Return The Return key will return to the main Recall menu. Return also removes the catalog display screen and restores the graph.

Recall Menu

MATH MENU

Introduction

The Math menu is used to smooth, fit, change and analyze the data in the display memory.

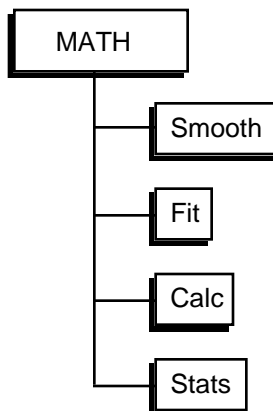
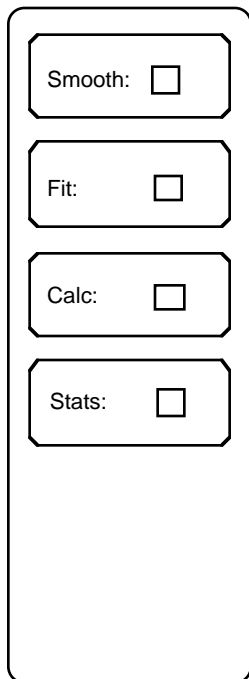

Math Keys

Each Math Key activates a sub menu. Each sub menu is described in detail in the following pages.

Smooth

The Smooth sub menu will smooth the data in the display memory using the Savitsky-Golay algorithm. For details on the Savitsky-Golay smoothing technique, see Abraham Savitsky and Marcel J. E. Golay, "Smoothing and Differentiation of Data by Simplified Least Squares Procedures", *Analytical Chemistry*, (36) 8, July 1964. In essence, smoothing removes features which are narrower than the number of smoothing points.

Smoothing is performed on the entire data record in display memory, regardless of graph scaling. Smoothing the data will change the data from integer count data into single precision (16 bits) floating point representation. Any calculation which requires a greater range will either underflow (return zero) or overflow. An operation which overflows will display an error message and abort.

Smoothing alters the data in the display memory. Original unsmoothed integer data may be recalled using the ReAcquire function in the Mode

Math Menu

menu. Once smoothed, the data remains in floating point form even when the Smooth menu is exited. If floating point data is saved to disk using the Save Trace function, it will be recalled as floating point data using Recall Trace. **To avoid accidentally losing original data, save the count data to a disk file before performing Smooth menu operations.**

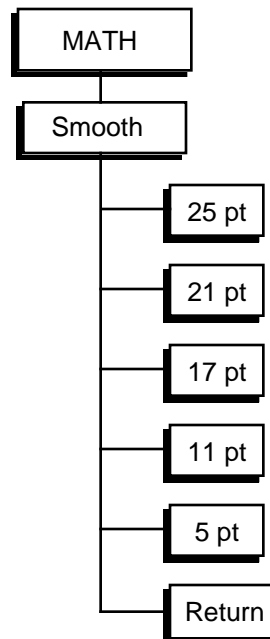
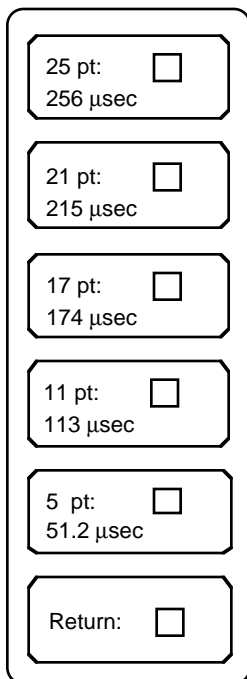

25 pt.
21 pt.
17 pt.
11 pt.
5 pt.

Pressing a smoothing key will smooth the data with the corresponding width. A width of 25 points means that features which span less than 25 bins will be smoothed out. The time displayed in each menu box is the smoothing width multiplied by the bin width and represents the real time smoothing width.

All of the data record in the display memory is smoothed, regardless of the graph display. While calculations are in progress, the "Calculating" message is displayed below the graph. Smoothing may be repeated until the desired noise reduction is attained.

Return

The Return key will return to the main Math menu.

Fit

The Fit sub menu allows the user to fit one of three curves to the displayed data: lines, exponentials, and Gaussians. Fitting is done using the Marquardt 'Gradient-expansion' algorithm to minimize chi-squared.

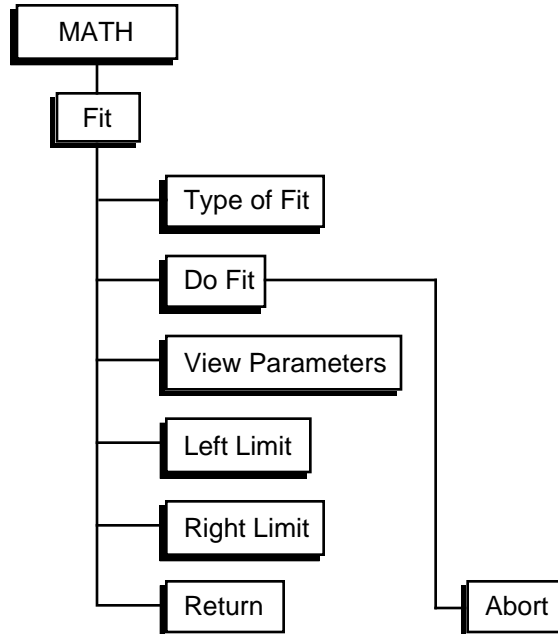
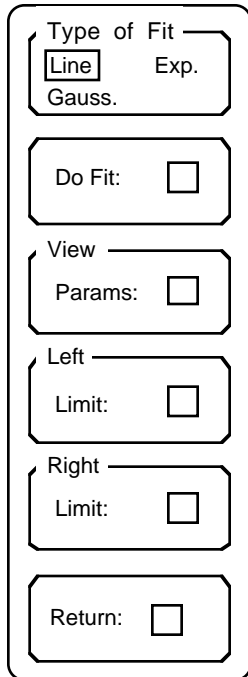

Type of Fit

This function toggles the Type of Fit between line, exponential, and Gaussian. The fit takes place only within the fit region defined by the Left and Right Limits (see below).

Do Fit

Pressing this key starts the actual fitting calculations. As each pass of the fitting routine progresses, the pass number and current value of chi-squared is displayed. The algorithm is designed to terminate when the change in chi-squared falls below 0.1%, although the fit may be terminated at any time by pressing the Abort key.

When the fit terminates, the best fit curve is plotted and the parameters of the fit are displayed at the bottom of the screen. Pressing any key to continue will restore the graph to normal. See View Parameters below for a description of each fit.

View Parameters

The View Parameters function displays the most recent curve fit and parameters. For example, if a fit was performed and then the Fit menu exited, the fit will be erased from the screen. If the graph is then scaled differently using the Display menu and then the Fit menu re-entered, the curve fit is redrawn. The View Parameters function re-displays the parameters.

Both the Do Fit and View Parameters functions result in a display screen

Math Menu

like the one shown below.
In this example screen, the fit is a line. The curve fit region is delimited by

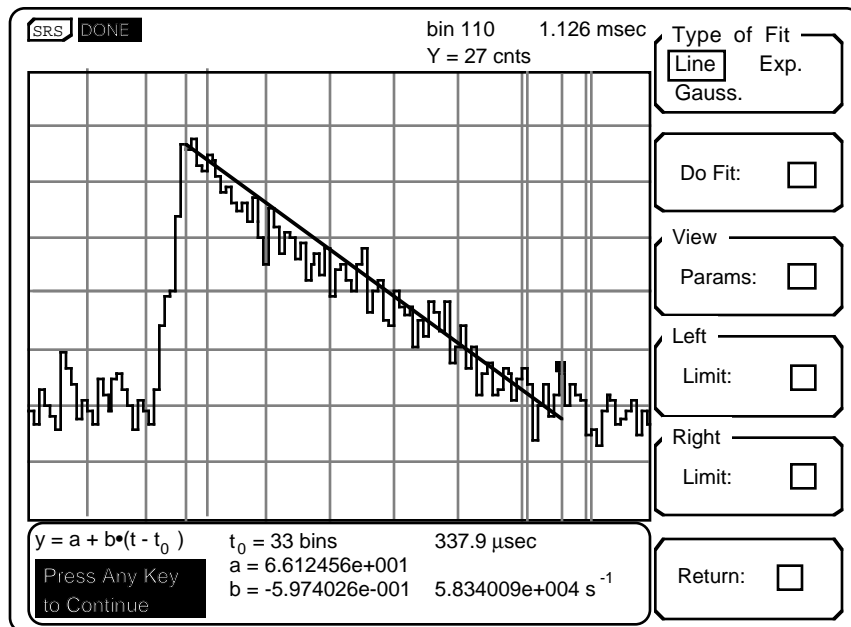

the two limit markers (heavy dashed vertical lines) as described below. The final curve fit is plotted between the limit markers along with the data. The parameters of the fit are displayed at the bottom of the screen.

Each type of fit, line, exponential, or Gaussian, has a different parameters display. The horizontal coordinate is t (in bins or time) and the vertical coordinate is y (in counts).

Line Fit: $y = a + b \cdot (t - t_0)$
 t_0 = horizontal offset in bins and time units
 a = vertical offset in number of counts
 b = slope in counts/bin and counts/second

Exp. Fit: $y = a e^{-(t - t_0)/b} + c$
 t_0 = horizontal offset in bins and time units
 a = amplitude in counts
 b = time constant in bins and time units
 c = vertical offset in counts

Gauss. Fit: $y = a e^{-(t/b)^2} + c$ where $t = t - t_0$
 t_0 = peak center position in bins and time units
 a = amplitude in counts
 b = line width in bins and time units
 c = vertical offset in counts

Left and Right Limit

The Left and Right Limit functions set the left and right limits of the fit region. The default positions of the limits are the the left and right edges of the graph. To move a limit, move the cursor using the knob or [PEAK]

key to the desired location of the limit. Pressing the Left or Right Limit key will set the limit to the cursor position. The Limits are set each time a limit key is pressed.

Return

The limits are displayed as heavy dashed vertical lines as shown below. The Return key will return to the main Math menu. Any displayed fit will be removed and the graph restored. Re-entering the Fit menu and using the View Parameters function will re-display the most recent fit.

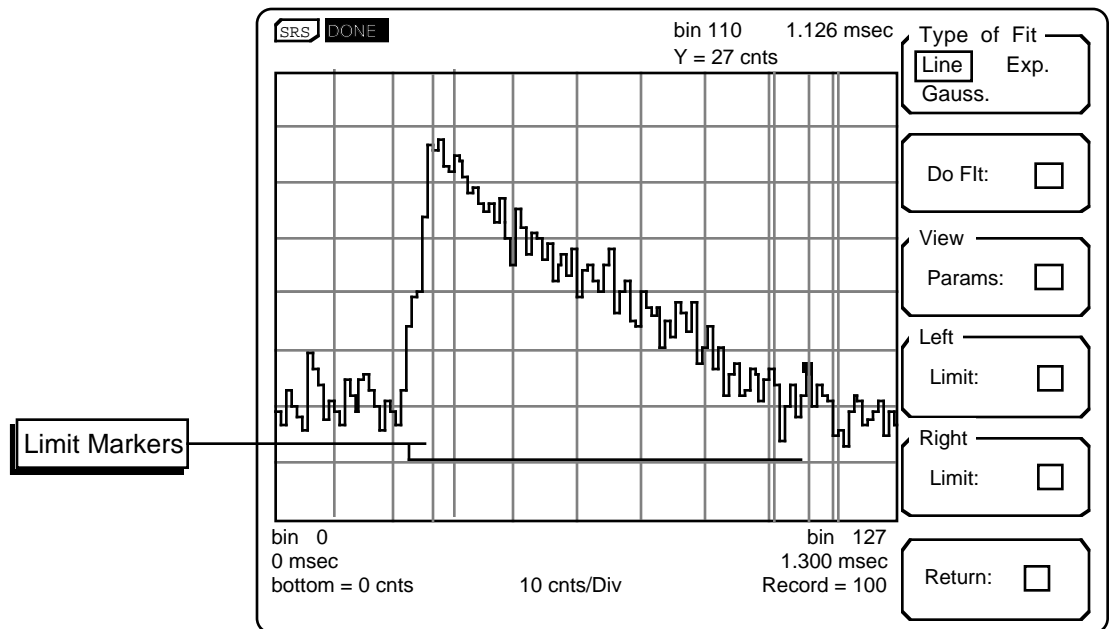

Math Menu

Calc

The Calculation sub menu allows the user perform simple arithmetic calculations with the displayed data. Operations are performed on the entire data record in display memory, regardless of graph scaling.

Performing a calculation on the data will change the data from integer count data into single precision (16 bits) floating point representation. Any calculation which requires a greater range will either underflow (return zero) or overflow. An operation which overflows will display an error message and abort.

Once converted, the data remains in floating point form even when the Calculation menu is exited. To convert the data back into integer count data, use the ReAcquire function in the Mode menu.

If floating point data is saved to disk using the Save Trace function, it will be recalled as floating point data using Recall Trace. **To avoid accidentally losing original data, save the count data to a disk file before performing Calc menu operations.**

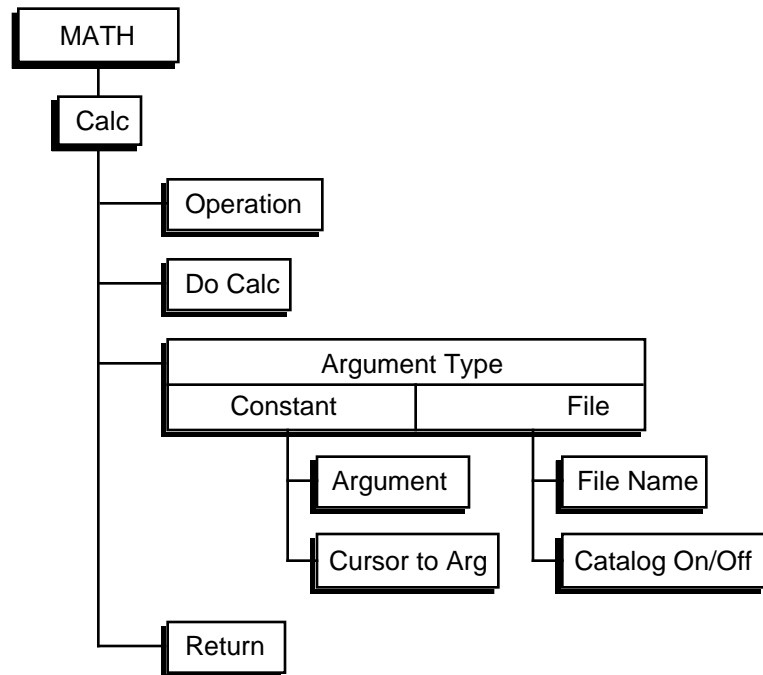
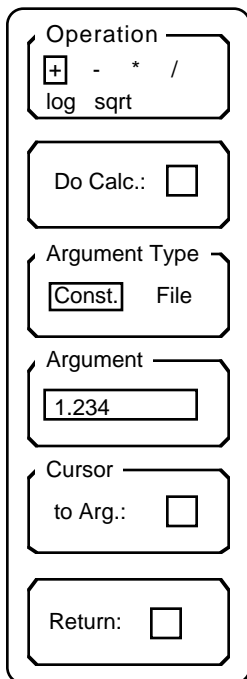

Operation

The Operation function selects the type of operation to be performed. The add, subtract, multiply, and divide functions require a second argument which may be a number or a data file. The log (base 10) and square root function require no argument.

Do Calc

Pressing this key starts the actual calculation. The "Calculating" message appears below the graph while calculations are in progress. The calculation uses the operation specified by the Operation key and uses the argument chosen by the Argument keys.

Note that many operations will require an AutoScale to display the result on the graph.

Argument Type

The Argument Type function selects between a constant argument and a data file on disk. A constant argument adds or subtracts a constant or multiplies or divides by a constant. A file argument uses a stored data file on disk as the argument. In this case, calculations are performed on a bin by bin basis, i.e. bin #0 is added to bin #0 from disk, bin #1 is added to bin #1 from disk, etc. Calculations continue from bin #0 until the last bin of either the displayed data or the disk file. In the case of divide, the displayed data is divided by the disk data.

If the Argument type is a constant, then the Argument and Cursor functions are displayed.

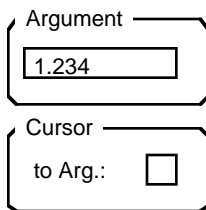

Argument

Pressing the Argument key activates the constant argument entry field. Use the keypad to enter a numerical argument. Integer (-3), real (-3.0), or floating point (-0.3E+1) formats are all allowed.

Cursor to Arg.

The Cursor to Argument will copy the data value of the cursor marker to the constant argument field above. This is convenient when subtracting a baseline or normalizing to a data point.

If the Argument type is a file, then the file selection functions are displayed.

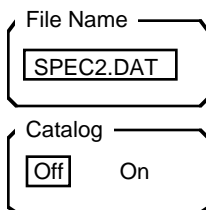

File Name

Pressing the File Name key activates the file name entry field. Use the Alternate keypad to enter a file name. The file name restrictions are the same as those in the Save and Recall menus.

Catalog On/Off

This key toggles the file catalog display screen on and off. The highlighted file name will be copied into the File Name entry field. Activate the cursor and use the knob to scroll through the file names. See the Save or Recall Trace section for a complete description of this function.

Return

The Return key will return to the main Math menu.

Math Menu

Stats

The Stats sub menu calculates a variety of statistical information about a display calculation region defined by the Left and Right Limits.

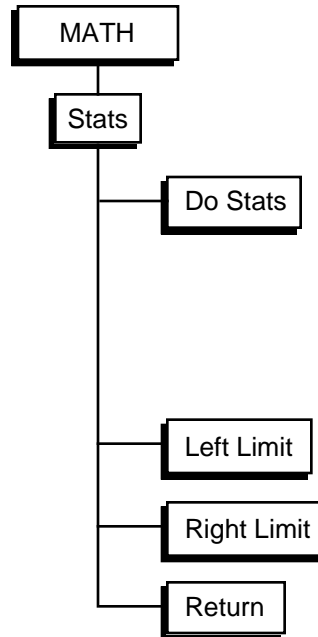
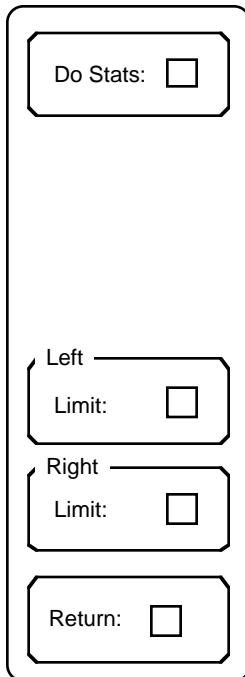

Do Stats

Pressing this key starts the actual calculation. The "Calculating" message appears below the graph while calculations are in progress. For the display region defined by the Left and Right Limits, the mean, standard deviation, total counts, and the area under the baseline defined by the two region endpoints are calculated and displayed below the graph.

The image shows a rectangular display area containing statistical results. The text is arranged in two columns. The left column contains "Total = 8.619800e+004" and "Press Any Key to Continue". The right column contains "Mean = 3.367109e+002", " σ = 1.936988e+001", and "Baseline Tot. = 3.840000e+004".

Left and Right Limit

The Left and Right Limit functions set the left and right limits of the calculation region. The default positions of the limits are the the left and right edges of the graph. To move a limit, move the cursor using the knob or [PEAK] key to the desired location of the limit. Pressing the Left or Right Limit key will set the limit to the cursor position. The Limits are set each time a limit key is pressed. The limits are shown as heavy dashed vertical lines on the graph. See the description of Limits under the Fit sub menu.

Return

The Return key will return to the main Math menu.

PLOT MENU

Introduction

The Plot menu is used to plot the screen display to an HPGL compatible plotter. Use the Setup Plotter menu to configure the plotter interface, plot speed, and pen definition.

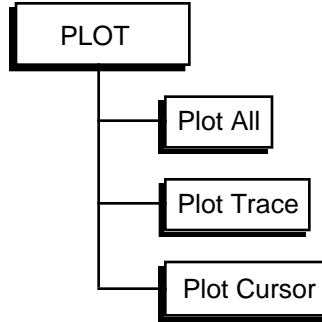
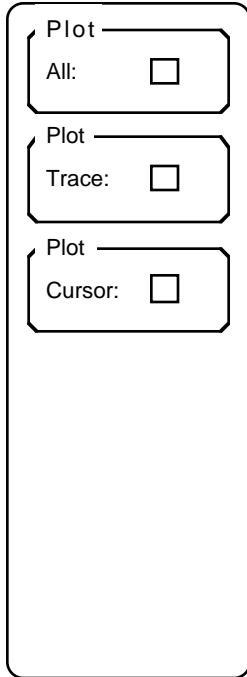

Plot All

The Plot All key generates a plot of the entire screen. Each feature uses the pen assigned in the Setup Plotter menu. Features such as the cursor or a curve fit are plotted only if they are presently displayed.

Plot Trace

The Plot Trace key plots only the data trace. This allows multiple data traces to be plotted on a single sheet. Traces may be made in different colors by changing pen definitions or pens between plots.

Plot Cursor

The Plot Cursor key plots the cursor markers if the cursor is presently displayed on the screen. Use the Display menu to turn the cursor display on and off.

Plot Menu

TEST MENU

Introduction

The Test menu allows the user to test various features of the SR430 such as the keypad, knob, screen, memory, etc. To test the data acquisition hardware, see the Test and Calibration section of the manual.

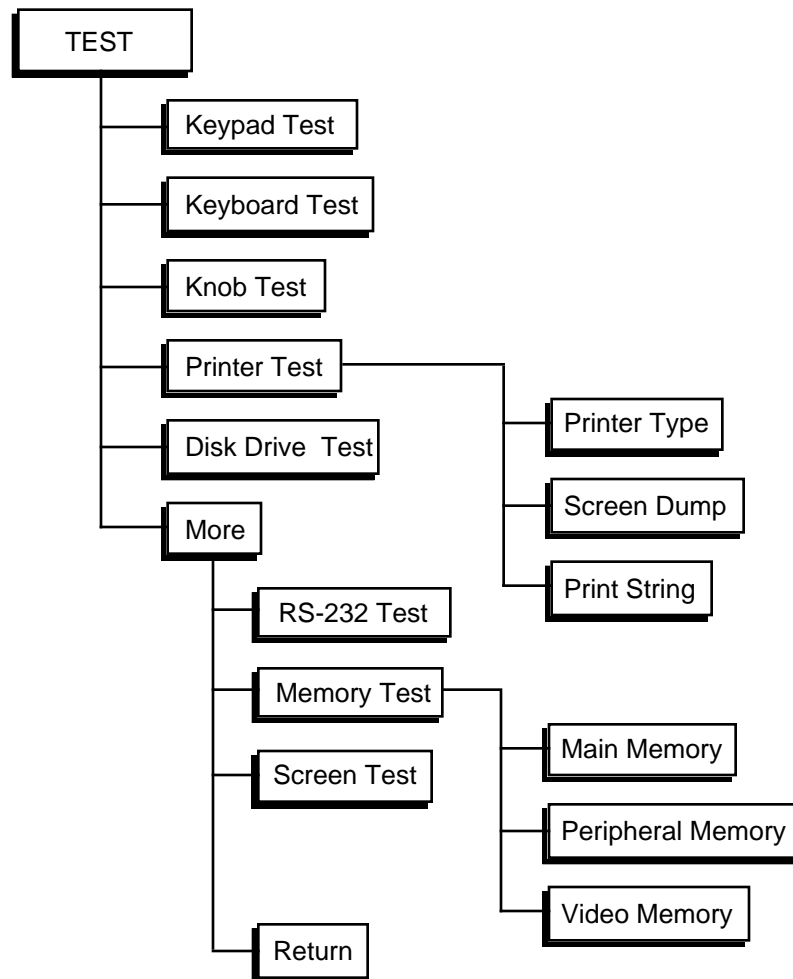
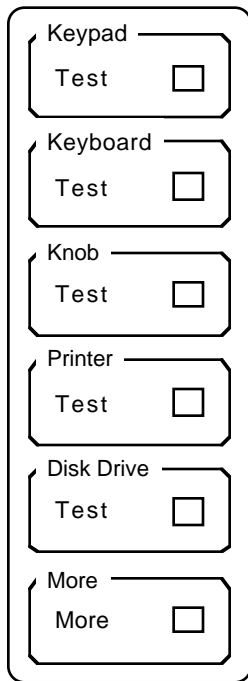

Keypad Test

This key activates the keypad test screen. The keypad test screen displays a map of the keypad with each key represented by a small square. Pressing each key will highlight the corresponding square. When all squares are highlighted, the test is complete.

Keyboard Test

This key activates the keyboard test screen. Characters typed on an attached PC keyboard (in PC or 8088 mode) will be displayed on the test screen. If the displayed characters are accurate, then the keyboard interface is functioning and the keyboard is configured correctly. If not, check that the keyboard is in correct mode. Many keyboards have a switch on the bottom to select PC (8088) or AT (80286) mode.

Test Menu

Knob Test

This key activates the knob test screen. A circle with a marker is displayed. Select one of the 4 speeds displayed in the menu. Turning the knob will cause the marker to move around the circle verifying knob action and direction. Using a slow speed is best when checking direction of movement.

Printer Test

The Printer Test key activates a sub menu.

Printer
HP EPSON

Screen Dump

Print String

Return:

Printer Type The Printer Type key selects the type of printer attached to the parallel printer port. Any Epson compatible graphics printer or HP LaserJet compatible printer is supported.

Screen Dump Pressing this key will print the graphics screen on the printer. This action is the same as using the [PRINT] key.

Print String Pressing this key prints a text string to the printer. If the Print String test works but the Screen Dump test fails, then the printer probably does not support the Epson or HP LaserJet graphics mode.

Return The Return key will return to the Test menu.

Disk Drive Test

Pressing this key activates the disk drive test screen. **Continuing with this test will destroy any data on the disk currently in the drive.** Therefore remove any disk containing data from the drive and insert a scratch disk. This test will check the controller, format the disk, and read and write data to the disk. The entire test takes approximately 2 minutes.

Use the Return function to skip this test and return to the previous menu.

More

The More key activates the second Test menu described below.

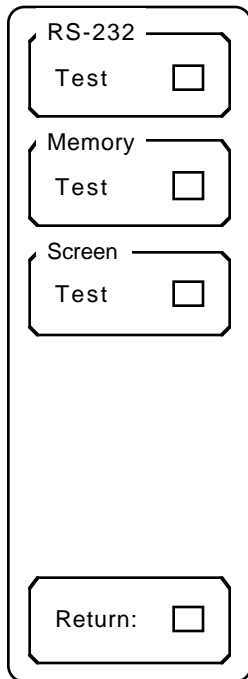

RS-232 Test

Pressing this key activates the RS232 test screen. A special loop back adapter is required to complete this test. The loop back adapter is simply a mating connector with pins 2 and 3 connected so characters transmitted by the interface will be received by the instrument.

Memory Test

The Memory Test key activates a memory test sub menu. Select the desired memory test.

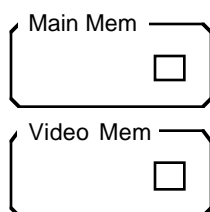

Main Memory Pressing this key tests the program ROM and data RAM on the CPU board. The data acquisition memory is not tested. See the Test and Calibration section for more information on testing the data acquisition hardware.

Video Memory Pressing this key tests the video display RAM. A video pattern will scroll through the display while the test is done.

Return The Return key will return to the Test menu.

Screen Test

This key displays a test pattern on the screen.

INFO MENU

Introduction

The Info menu displays various information screens which may be helpful to the user.

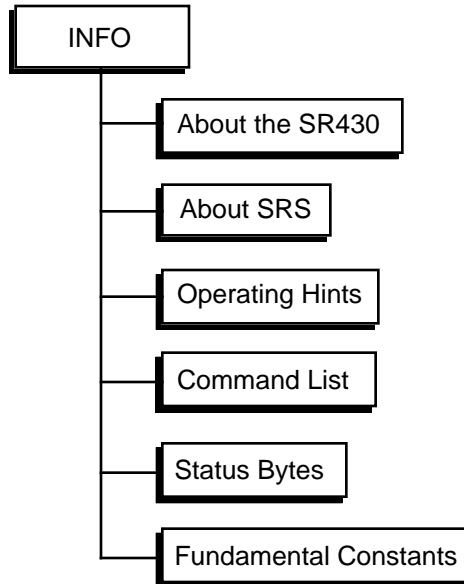
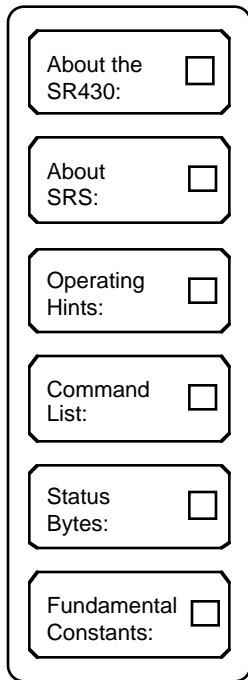

About the SR430

This key displays the SR430 specifications.

About SRS

This key displays information about Stanford Research Systems, Inc.

Operating Hints

This key displays information about the use of the SR430.

Command List

This key displays a list of the remote commands available.

Status Bytes

This key displays an explanation of the remote programming status bytes.

Fundamental Constants

This key displays a table of fundamental constants.

INSTRUMENT SETUPS

DEFAULT SETUP / POWER ON CLEAR

If the [CLR] key is held down when the power is turned on, the instrument settings will be set to the defaults shown below instead of the settings in effect when the power was turned off.

<u>Menu Item</u>	<u>Setting</u>	<u>Menu Item</u>	<u>Setting</u>
Trigger Level	100 mV	RS232 Parity	None
Trigger Slope	Positive	GPIB Address	8
Discriminator Level	-10.0 mV	Override Remote	No
Discriminator Slope	Negative	Key Click	On
Aux 1 Level	0.0 V	Alarms	On
Aux 2 Level	0.0 V	Plot Mode	RS232
		Plotter Baud Rate	9600
Bin Clock Source	Internal	Plotter Address	1
Bin Width	5 ns	Plot Speed	Fast
Bins/Record	1k	Trace Pen	1
Records/Scan	1000	Grid Pen	1
Trigger Offset	0	Alpha Pen	1
Accumulate Mode	Add	Cursor Pen	1
Toggle Count	1	Fit Pen	1
Pause At Toggle	No	Printer Type	1
From Offset	0		
Cursor	On	File Name	None
Cursor Width	Wide	Type of Fit	Line
Cursor Seeks	Maximum	Operation	+
Grid	On	Argument Type	Constant
		Argument	0.0
Output To	GPIB	Status Enable	
RS232 Baud Rate	9600	Registers	Cleared
RS232 Word Length	8 bits		

If there is a memory error when the unit is turned on, then the default settings will be used instead of the set-up retained in memory. This can be due to a low battery.

The default setup may also be recalled using the *RST command. In this case, the communications parameters and status registers are not changed.

Instrument Setups

CHOOSING BIN WIDTH AND RECORD LENGTH

A single record acquires data for a time equal to the number of bins per record times the bin width. The acquisition starts from the trigger time. The SR430 can acquire up to 32k bins in a single record at up to 10.486 ms per bin for a maximum record time of 343 seconds. In an experimental situation, the record time must cover the time of interest.

Once the desired record time has been determined, the bin width needs to be chosen. The bin width determines the time resolution of the measurement. In general, there are a number of combinations of bins per record and bin width which will yield the same record time. For example, 2k bins at 10.24 μ s per bin and 1k bins at 20.48 μ s per bin both have a record time of 20.9 ms. What combination should be used? First of all, there are restrictions on the number of bins per record and the bin width. There must be at least 1k bins in the record and only certain bin widths are available. The bin width should reflect the desired resolution of the measurement. If features as small as 5.12 μ s are to be seen, then the bin width should be 5.12 μ s (4k bins/record) or smaller. If resolution is not required, use a wider bin width. In this example, 20.48 μ s is the widest bin which will still allow a record time of 20.9 ms due to the 1k minimum record length.

Why not always use the narrowest bin for the best resolution? One reason is that the data record has many more points. Many functions such as scaling, fitting, calculations, etc. will take longer to perform on longer data records. Another reason is that each individual bin will have a smaller number of counts. Because statistical count noise is equal to the square root of the count, the signal to noise ratio of each bin will be worse. If wide features are being curve fit, then the many bins does not degrade the data since there are the same number of total counts as the fewer bins record. In this case, smoothing can be used to reduce the noise and the resolution.

Why not always use the widest bin for the best signal to noise in each bin and the fastest processing time? One reason is that since the data in each bin will be larger, the bins may overflow sooner. When data overflows, then the bin width needs to be reduced so that more bins split up the large data points. Another reason is that wide bins mean less resolution when measuring narrow features. When curve fitting over a small number of bins, the fit may be less accurate.

Thus, choosing the combination of bin width and

number of bins is a compromise in many situations. In general, do not use more bins than necessary since the extra resolution may not yield any more information. Data may need to be taken with a few combinations before the "best" and most "convenient" combination is found.

ACCUMULATION

A single record can capture a transient counting event if there are enough counts to be statistically significant in a single shot. If the count rate is very low but the signal is repetitive, then multiple records may be accumulated together. This increases the counts in each bin and improves the signal to noise of each data point.

If a narrow bin width is used, it may be necessary to accumulate many records to achieve an acceptable signal to noise ratio for an individual bin. In this case, a wider bin width could achieve the same signal to noise per bin with less records. This is because each bin will have more counts due to its longer width. This is another reason not to use a bin narrower than necessary.

Accumulation can also be used to subtract background signals. Using the Toggle or External modes of accumulation allows records to be subtracted as well as added. A typical experiment would add records whenever the signal is present and subtract background records without signal. The TOGGLE OUTPUT or SUBTRACT INPUT can be used to synchronize the signal with the accumulation. Using a toggle mode does have a drawback though. Because the data can now be positive and negative, the count range is restricted to ± 16384 instead of 32767. However, background accumulation is eliminated.

USING THE TRIGGER OFFSET

If the desired bin width results in the time of interest occurring more than 16k bins after the trigger, the trigger offset must be used. The number of bins acquired is equal to the sum of the trigger offset and the number of bins per record and can be as large as 32k. The SR430 can only display 16k data points at a time. The trigger offset is used to skip bins in the data acquisition memory and display only the region of interest. The trigger offset essentially delays the trigger by a number of bins. If a delay larger than 32k bins is required, then a delay generator is needed to delay the actual trigger pulse.

USING SYNC/BUSY

After a trigger is recognized, the SYNC/BUSY out-

put will go high indicating the start of the first time bin. The insertion delay from TRIGGER to SYNC/BUSY is 45 ns. SYNC/BUSY will have 2.5 ns of indeterminacy with respect to the trigger. As a result, the entire record starts with 2.5 ns of uncertainty with respect to the trigger. This is not a problem if the bin width is much longer than 2.5 ns but may be a problem for shorter bin widths. In these cases, the SYNC/BUSY output should be used to trigger the experiment. Since the record is synchronized to SYNC/BUSY, there will be no indeterminacy of the time bins with respect to the experiment. One way to accomplish this is to trigger the SR430 with the experiment's master rate generator and use the SYNC/BUSY (which is delayed from trigger by only 45 ns) to trigger the actual experiment.

REMOTE PROGRAMMING

The SR430 Multichannel Scaler/Averager may be remotely programmed via either the RS232 or GPIB (IEEE-488) interfaces. Any computer supporting one of these interfaces may be used to program the SR430. Both interfaces are receiving at all times, however, **the SR430 will send responses only to the interface specified in the Setup menu** (Output To RS232/GPIB function). Use the OUTF command at the beginning of every program to direct the responses to the correct interface. All front and rear panel features (except power) may be controlled.

COMMUNICATING WITH GPIB

The SR430 supports the IEEE-488.1 (1978) interface standard. It also supports the required common commands of the IEEE-488.2 (1987) standard. Before attempting to communicate with the SR430 over the GPIB interface, the SR430's device address must be set. The address is set in the Setup GPIB menu and may be set between 0 and 30.

COMMUNICATING WITH RS232

The SR430 is configured as a DCE (transmit on pin 3, receive on pin 2) and supports CTS/DTR hardware handshaking. The CTS signal (pin 5) is an output indicating that the SR430 is ready, while the DTR signal (pin 20) is an input that is used to control the SR430's data transmission. If desired, the handshake pins may be ignored and a simple 3 wire interface (pins 2,3 and 7) may be used. The RS232 interface baud rate, number of data bits, and parity must be set. These are set in the Setup RS232 menu.

STATUS INDICATORS AND QUEUES

To assist in programming, the SR430 has 4 interface status indicators which are displayed at the top of the screen. The **Activity** indicator flashes whenever a character is received or transmitted over either interface. The **ERR** indicator flashes when an error has been detected, such as an illegal command, or parameter out of range. The **REM** indicator is on whenever the SR430 is in a remote state (front panel locked out). The **SRQ** indicator is on when the SR430 generates a service request. **SRQ** stays on until a serial poll is completed.

To help find program errors, the SR430 can display the interface buffers on the screen. This screen is activated by the View Queues function in the Setup Communications menu. The last 256 characters received or transmitted by the SR430

are displayed. The View Queues screen will display the interface buffers as they are when the screen is activated. Any further activity will not update the screen until a new screen is displayed using the View Queues key.

COMMAND SYNTAX

Communications with the SR430 use ASCII characters. Commands may be in either UPPER or lower case and may contain any number of embedded space characters. A command to the SR430 consists of a four character command mnemonic, arguments if necessary, and a command terminator. The terminator must be a line-feed <lf> or carriage return <cr> on RS232, or a linefeed <lf> or EOI on GPIB. No command processing occurs until a command terminator is received. Commands function identically on GPIB and RS232 whenever possible. Command mnemonics beginning with an asterisk "*" are IEEE-488.2 (1987) defined common commands. These commands also function identically on RS232. Commands may require one or more parameters. Multiple parameters are separated by commas (,).

Multiple commands may be sent on one command line by separating them with semicolons (;). The difference between sending several commands on the same line and sending several independent commands is that when a command line is parsed and executed, the entire line is executed before any other device action proceeds.

There is no need to wait between commands. The SR430 has a 256 character input buffer and processes commands in the order received. If the buffer fills up, the SR430 will hold off handshaking on the GPIB and attempt to hold off handshaking on RS232. Similarly, the SR430 has a 256 character output buffer to store output until the host computer is ready to receive it. If either buffer overflows, both buffers are cleared and an error reported.

The present value of a particular parameter may be determined by querying the SR430 for its value. A query is formed by appending a question mark "?" to the command mnemonic and omitting the desired parameter from the command. Values returned by the SR430 are sent as a string of ASCII characters terminated by a carriage return <cr> on RS232 and by a line-feed <lf> on GPIB. If multiple queries are sent on one command line (separated by semicolons, of course) the answers will be returned individually, each with a terminator.

Examples of Command Formats

Remote Programming

DCSL 0<lf>	Set discriminator slope to positive
DCLV 10E-3 <lf>	Set the discriminator level to 10 mV (10E-3 Volts)
*IDN? <lf>	Queries the device identification
SSCN <lf>	Starts data acquisition (same as [START] key)
RSCN? <lf>	Queries the number of records per scan

<lf> will save the data to disk and return the Error Status Byte when finished. The Disk Error bit may be checked to make sure that the Save Trace command terminated without error. Since the Save Trace command may take a long time to execute, it is important that the host computer interface does not time out while waiting for the response to the ERRS? query. In the case where the host interface times out before the ERRS? response, the host program must wait before sending the ERRS? query.

INTERFACE READY AND STATUS

The Interface Ready bit in the Serial Poll Status Byte signals that the SR430 is ready to receive and execute a command. When a command is received, this bit is cleared indicating that an operation is in progress. While the operation is in progress, no other commands will be processed. Commands received during this time are stored in a buffer to be processed later. Only GPIB serial polling will generate a response while a command is in progress. When the command execution terminates, the Interface Ready bit is set again and new commands will be processed. Since most commands execute very quickly, the host computer does not need to continually check the Interface Ready bit. Commands may be sent one after another and they will be processed immediately.

However, some commands, such as file commands and math operations, may require a long time to execute. In addition, the host program may need to check that these operations executed without error. In these cases, after the command is sent, the Status Bytes should be queried.

When using the GPIB interface, serial polling may be used to check Interface Ready bit in the Serial Poll Byte while an operation is in progress. After the Interface Ready bit becomes set, signalling the completion of the command, then the ERR bit may be checked to verify successful completion of the command.

If the RS232 interface is used, or serial polling is not available, then the *STB?, *ESR?, ERRS?, and MCSS? status query commands may be used to query the Status Bytes. Since the SR430 processes one command at a time, the status query will not be processed until the previous operation is finished. Thus a response to the status query in itself signals that the previous command is finished. The query response may then be checked for various errors.

For example, the command line SVTR;ERRS?

DETAILED COMMAND LIST

The four letter mnemonic in each command sequence specifies the command. The rest of the sequence consists of parameters. Multiple parameters are separated by commas. Parameters shown in { } are optional or may be queried while those not in { } are required. Commands that may be queried have a question mark in parentheses (?) after the mnemonic. Commands that may ONLY be queried have a ? after the mnemonic. Commands that MAY NOT be queried have no ?. Do not send () or { } as part of the command.

The variable i is an integer. The variable x is a real number.

All variables may be expressed in integer, floating point or exponential formats (i.e., the number five can be either 5, 5.0, or .5E1).

IMPORTANT NOTE: All responses are directed to the interface selected in the Setup Communications-Output To RS232/GPIB function, regardless of which interface received the query. Use the OUTP command to select the correct interface at the beginning of every program.

LEVEL CONTROL COMMANDS

TRLV (?) {x}	The TRLV command sets or reads the trigger threshold level. The TRLV x command sets the trigger level to x Volts where -2.000 x 2.000. The resolution is .001V. The TRLV? command queries the trigger level. The response is a floating point value.
TRSL (?) {i}	The TRSL command selects the trigger slope. The parameter i=0 selects positive or rising slope, while i=1 selects negative or falling slope.
DCLV (?) {x}	The DCLV command sets or reads the discriminator threshold level. The DCLV x command sets the discriminator level to x Volts where -0.300 x 0.300. The resolution is 0.0002V (0.2 mV). The DCLV? command queries the discriminator level. The response is a floating point value.
DCSL (?) {i}	The DCSL command selects the discriminator slope. The parameter i=0 selects positive or rising slope, while i=1 selects negative or falling slope.
AUX1 (?) {x}	The AUX1 command sets or reads the AUX 1 output level. The AUX1 x command sets the output level to x Volts where -10.000 x 10.000. The resolution is 0.005V (5 mV). The AUX1? command queries the output level. The response is a floating point value.
AUX2 (?) {x}	The AUX2 command sets or reads the AUX 2 output level. The AUX2 x command sets the output level to x Volts where -10.000 x 10.000. The resolution is 0.005V (5 mV). The AUX2? command queries the output level. The response is a floating point value.

MODE CONTROL COMMANDS

The parameters in the Mode menu are not adjustable unless the unit is cleared (no data in memory). If the unit is BUSY or DONE with data acquisition, the mode menu parameters (with the exception of ROFF) are not adjustable. An execution error is generated if a Mode Control Command which attempts to change a mode parameter is received during BUSY, PAUSE, or DONE states. Use the serial poll status byte to determine if the SR430 is CLEAR.

BCLK (?) {i} The BCLK command sets or reads the bin clock time base. The parameter $i=0$ selects internal, while $i=1$ selects external. When set to external, the EXT BIN CLK input determines the width of each bin.

BWTH (?) {i} The BWTH command selects the internal time base bin width. The parameter i selects a bin width as shown below.

i	<u>bin width</u>	i	<u>bin width</u>
0	5 ns	10	20.48 μ s
1	40 ns	11	40.96 μ s
2	80 ns	12	81.92 μ s
3	160 ns	13	163.84 μ s
4	320 ns	14	327.68 μ s
5	640 ns	15	655.36 μ s
6	1.28 μ s	16	1.3107 ms
7	2.56 μ s	17	2.6214 ms
8	5.12 μ s	18	5.2429 ms
9	10.24 μ s	19	10.486 ms

BREC (?) {i} The BREC command sets or reads the bins per record. The record length is programmed in 1k (1024) steps. The parameter i is an integer from 1 to 16. If the parameter $i=1$, the record length is 1k (1024). If $i=2$, the record length is 2k (2048), and so on. The maximum value of i is 16 for a maximum record length of 16k (16,384).

RSCN (?) {i} The RSCN command sets or reads the records per scan. The records per scan is the number of records which will be accumulated. The records/scan may be programmed from 0 to 65535. When set to 0, accumulation will continue indefinitely. Changing the records per scan during data acquisition is allowed. If the new value exceeds the current record number, then the scan will continue until the new number of records has been acquired. If the new value is lower than the current record number, the scan will end after the next accumulation.

BOFF (?) {i} The BOFF command sets or reads the trigger offset. The trigger offset may be programmed from 0 to 16320 in increments of 16. The value of i is rounded to the nearest multiple of 16. The BOFF? query responds with the integer i .

ACMD (?) {i} The ACMD command sets or reads the accumulate mode. The parameter $i=0$ selects add, $i=1$ selects toggle, $i=2$ selects external.

TCNT (?) {i} The TCNT command sets or reads the toggle count. The toggle count may be programmed from 1 to 16384.

PTOG (?) {i} The PTOG command sets or reads the pause at toggle state. If the parameter $i=0$, pause at toggle is not selected. If $i=1$, pause at toggle is selected.

- REAC** The REAC command performs the ReAcquire function. The display buffer is restored with original count data from the data acquisition memory. Reacquire will only function when the SR430 is in the DONE state.
- ROFF (?) {i}** The ROFF command sets or reads the ReAcquire From Offset value. The parameter *i* programs the offset from 0 to the trigger offset in increments of 16 bins. The value of *i* is rounded to the nearest multiple of 16. ROFF may be used when the SR430 is in the DONE state.

DISPLAY CONTROL COMMANDS

- AUTS** The AUTS command performs the AutoScale function. This function is exactly the same as pressing the [AUTOSCALE] key. The AUTS command may affect the BOTM and VSCL parameters below.
- CRPK** The CRPK command performs the same function as pressing the [PEAK] key. The cursor region will be centered around the maximum data value on the screen. The cursor marker position depends upon the cursor mode.
- BUGP?** The BUGP? query reads the bin number where the cursor marker is located. Using the BUGP? query after the CRPK command reads the position of the on screen peak.
- CNTR** The CNTR command performs the same function as pressing the [CENTER] key. The graph will be horizontally translated to place the bin corresponding to the cursor marker at the center of the graph. The LEFT parameter will be affected.
- LEFT (?) {i}** The LEFT command sets or reads the number of the bin at the left edge of the screen. The LEFT *i* command translates the graph horizontally to place bin #*i* at the left edge. The parameter *i* may range from 0 to the number of bins per record minus the number of bins per screen, i.e. the graph may not be translated to display a bin which is beyond the end of the record.
- BOTM (?) {i} {x}** The BOTM command sets or reads the minimum displayed Y value. The BOTM *i* or BOTM *x* commands translate the graph vertically to make the Y value corresponding to the bottom of the graph equal to *i* or *x*.
- The parameter *i* is used when the graph displays integer count data. The value of *i* may range from -32767 to 32767.
- The parameter *x* is used when the graph displays floating point data. The value of *x* is rounded to the nearest 1/10 of a division. Values of *x* which translate the data far off screen may be limited to a maximum or minimum value, depending upon the range of the data.
- HSCL (?) {i}** The HSCL command sets or reads the horizontal screen width. The parameter *i* selects a screen width below. The screen width may not be set such that the screen width plus the left most bin exceeds the number of bins per record, i.e. the graph may not be scaled to display a bin which is beyond the end of the record. Unlike horizontal scaling from the front panel which takes place about the cursor position, the HSCL command leaves the left most bin fixed while changing the screen width.

Remote Programming

<i>i</i>	<u>screen width in bins</u>	<i>i</i>	<u>screen width in bins</u>
0	8	12	6k
1	16	13	7k
2	32	14	8k
3	64	15	9k
4	128	16	10k
5	256	17	11k
6	512	18	12k
7	1k	19	13k
8	2k	20	14k
9	3k	21	15k
10	4k	22	16k
11	5k		

VSCL (?) {i} {x}

The VSCL command sets or reads the vertical scale. Unlike vertical scaling from the front panel which takes place about the center of the screen, the VSCL *i* or VSCL *x* commands change the vertical scale while leaving the BOTM value unchanged.

The parameter *i* is used when the graph displays integer count data. The value of *i* is the number of counts per vertical division and ranges from 1 to 5000 in a 1-2-5-10 sequence. The value of *i* is rounded down to the nearest allowed scale.

The parameter *x* is used when the graph displays floating point data. The value of *x* is the vertical scale per division. Allowable *x* values proceed in a 1-2-5-10 sequence. The value of *x* is rounded down to the nearest allowed scale. There is no practical maximum value for *x*, the graph simply compresses to a line. However, there is a minimum value of *x* which depends upon the range of the data (maximum data value - minimum data value). Because the floating point data is single precision, the minimum value of *x* is 0.07% of the range of the data. The graph may be expanded to show 0.55% (8 divisions) of the data range.

CURS (?) {i}

The CURS command sets or reads the cursor on/off condition. If *i*=0, the cursor is off. If *i*=1, the cursor is on.

CURW (?) {i}

The CURW command sets or reads the cursor width. If *i*=0 the cursor is normal, if *i*=1 the cursor is wide, and if *i*=2 the cursor is a spot cursor.

CURM (?) {i}

The CURM command sets or reads the cursor seek mode. If *i*=0 the cursor marker seeks the maximum, if *i*=1 the marker seeks the minimum, and if *i*=2 the marker seeks the mean.

GRID (?) {i}

The GRID command sets or reads the grid on/off condition. If *i*=0 the grid is off and if *i*=1 the grid is on.

SETUP COMMANDS

SETUP COMMANDS

OUTP (?) {i}	The OUTP command sets the output interface to RS232 (i=0) or GPIB (i=1). The OUTP i command should be sent before any query commands to direct the responses to the interface in use.
KCLK (?) {i}	The KCLK command sets or reads the key click on (i=1) or off (i=0) state.
ALRM (?) {i}	The ALRM command sets or reads the alarm on (i=1) or off (i=0) state.
THRS (?) {i}	The THRS command sets or reads the hours setting of the clock. The value of i is in the range 0 i 23.
TMIN (?) {i}	The TMIN command sets or reads the minutes setting of the clock. The value of i is in the range 0 i 59.
TSEC (?) {i}	The TSEC command sets or reads the seconds setting of the clock. The value of i is in the range 0 i 59.
DMTH (?) {i}	The DMTH command sets or reads the months setting of the calendar. The value of i is in the range 1 i 12.
DDAY (?) {i}	The DDAY command sets or reads the days setting of the calendar. The value of i is in the range 1 i 31.
DYRS (?) {i}	The DYRS command sets or reads the years setting of the calendar. The value of i is in the range 0 i 99.
PLTM (?) {i}	The PLTM command sets or reads the plotter mode. If i=0 plotting is directed to the RS232 interface, if i=1 plotting is to the GPIB interface.
PLTB (?) {i}	The PLTB command sets or reads the RS232 plotter baud rate. The parameter i ranges from 0 to 4 and selects baud rates of 300 (0), 1200 (1), 2400 (2), 4800 (3), and 9600 (4). This baud rate should match the baud rate of the plotter in use.
PLTA (?) {i}	The PLTA command sets or reads the GPIB plotter address. The parameter i ranges from 0 to 30 and should agree with the address of the plotter in use.
PLTS (?) {i}	The PLTS command sets or reads the plot speed. If i=0 fast plot speed is used, if i=1 slow plot speed is used.
PNTR (?) {i}	The PNTR command sets or reads the trace pen number. The pen number is in the range of 1 to 6.
PNGD (?) {i}	The PNGD command sets or reads the grid pen number. The pen number is in the range of 1 to 6.
PNAP (?) {i}	The PNAP command sets or reads the alphanumeric pen number. The pen number is in the range of 1 to 6.

Remote Programming

PNCR (?) {i}	The PNCR command sets or reads the cursor pen number. The pen number is in the range of 1 to 6.
PNFT (?) {i}	The PNFT command sets or reads the fit pen number. The pen number is in the range of 1 to 6.
PRNT (?) {i}	The PRNT command sets or reads the printer type. The printer type may be EPSON (i=0) or HP (i=1).

SAVE AND RECALL FILE COMMANDS

When using file commands, the status byte should be queried after the command is sent to check if the command generated an error. Common sources of errors are file not on disk, no space on disk, and no disk in drive. For example, the command line SVTR;ERRS? <lf> will save the data to disk and return the Error Status Byte when finished. The Disk Error bit may be checked to make sure that the Save Trace command terminated without error.

FNAM (?) {string}	The FNAM command sets or reads the active file name. All file operations use the name specified by the FNAM command. Be sure to use the FNAM string command before any file operation commands. For example, "FNAM MYDATA.DAT" will set the active file name to MYDATA.DAT. DOS file name conventions must be followed, i.e. file names are 8 characters or less with an optional extension of up to 3 characters. Subdirectories are not supported. All file access is to the root directory.
SVTR	The SVTR command saves the current display memory data, settings, and scaling parameters to the file specified by the FNAM command.
SVST	The SVST command saves the settings in the Levels and Mode menu to the file specified by the FNAM command. The settings represent the hardware configuration of the data acquisition.
SVSS	The SVSS command saves the system configuration information in the Setup menu to the file specified by the FNAM command.
RCTR	The RCTR command recalls data, settings, and scaling parameters from the file specified by the FNAM command.
RCST	The RCST command recalls settings information (Levels and Mode menus) from the file specified by the FNAM command.
RCSS	The RCSS command recalls system configuration parameters (Setup menu) from the file specified by the FNAM command.

MATH OPERATION COMMANDS

When using the math commands SMTH, FITS, CALC, and STAT, the status bytes should be queried after the command is sent to check if the command generated an error. Common sources of errors are divide by zero, math overflow or underflow, and file not on disk. For example, the command line FITS;*ESR? <lf> will perform a curve fit and return the Standard Event Status Byte when finished. The Execution Error bit may be checked to make sure that the FITS command terminated without error.

SMTH i

The SMTH i command smooths the data. This may take some time. Use a status byte query to detect when the smoothing operation is done. The parameter i selects a smoothing width.

i	<u>smoothing width</u>
0	5 points
1	11 points
2	17 points
3	21 points
4	25 points

FTYP (?) {i}

The FTYP command sets or reads the type of fit. The parameter i selects the type of fit. If i=0 the fit is a line, if i=1 the fit is exponential, and if i=2 the fit is Gaussian.

FITS

The FITS command starts the actual fitting calculations. The fit takes place only within the fit region defined by the LLIM and RLIM commands. The fit progresses until the change in chi-squared falls below 0.1%. This may take some time. Use a status byte query to detect when the fit operation is done. If the FITS command is used before the LLIM and RLIM commands have set the limits, the results are invalid and an execution error may result.

The FITS command uses the limits set by LLIM and RLIM and not the front panel limits. Conversely, the front panel Do Fit function uses the on screen limits, and not the LLIM and RLIM limits. Using the View Parameters function will display the most recent fit parameters, whether the fit was performed from the front panel or from the computer interface.

PARS ? i

The PARS? i command queries the fit parameters after a curve fit has been performed. If no fit has been done or the selected parameter is unused in the fit, the PARS? command returns invalid data. The curve fit parameters are t0, a, b, and c (see the Math menu section of this manual). The parameter i in the PARS? i command selects a fit parameter to read. The value of i from 0 to 3 selects t0, a, b, and c.

LLIM (?) {i}

The LLIM command sets or reads the left limit of the curve fit region. The parameter i is the bin # of the record which is the left limit. Unlike the limits set by the cursor from the front panel, which must be on the graph, the LLIM command can set the limit at any bin # within the record. The parameter i must be in the range 0 < i < number of bins per record and i must be less than the right limit set by RLIM.

RLIM (?) {i}

The RLIM command sets or reads the right limit of the curve fit region. The parameter i is the bin # of the record which is the right limit. Unlike the limits set by the cursor from the front panel, which must be on the graph, the RLIM command can set the limit at any bin # within the record. The parameter i must be in the range 0 < i < number of bins per

Remote Programming

record and *i* must be greater than the left limit set by LLIM.

OPER (?) {*i*}

The OPER command sets or reads the type of math operation selected. The parameter *i* selects the operation.

<i>i</i>	<u>operation</u>
0	+
1	-
2	x
3	/
4	log
5	sqrt

CALC

The CALC command starts the calculation selected by the OPER command. This may take some time. Use status byte query to detect when the calculation is done. Make sure that ARGM or FNAM have been used to set the argument value before using the CALC command. CALC will convert the count data into floating point data.

ARGT (?) {*i*}

The ARGT command sets or reads the argument type. The parameter *i* selects Constant (*i*=0) or File (*i*=1).

ARGM (?) {*x*}

The ARGM command sets or reads the constant argument. The parameter *x* is a real number.

FNAM (?) {string}

The FNAM command sets or reads the active file name for file arguments. All file operations use the name specified by the FNAM command. **Be sure to use the FNAM string command before any file operation commands.** For example, "FNAM MYDATA.DAT" will set the active file name to MYDATA.DAT. DOS file name conventions must be followed, i.e. file names are 8 characters or less with an optional extension of up to 3 characters. Subdirectories are not supported. All file access is to the root directory.

STAT

The STAT command starts the statistical calculations. Only the data within the region specified by the LLIM and RLIM limits is analyzed. Use status byte query to detect when the statistical calculation is done. If the STAT command is used before the LLIM and RLIM commands have set the limits, the results are invalid and an execution error may result.

SPAR ? *i*

The SPAR? *i* command queries the results of a statistical calculation. If no STAT command has been done, the SPAR? command returns invalid data. The STAT command calculates the mean, standard deviation, total area, and the baseline area for the data within the limits set by LLIM and RLIM (see the Math menu section of this manual). The parameter *i* in the SPAR? *i* command selects the parameter to read. The value of *i* from 0 to 3 selects mean, standard deviation, total area, and baseline area.

PRINT AND PLOT COMMANDS

When using the print or plot commands, the status bytes should be queried after the command is sent to check if the command generated an error. Common sources of errors are printer/plotter not connected and printer/plotter interface incorrectly configured. For example, the command line PALL;ERRS? <lf> will plot the screen and return the Error Status Byte when finished. The Plot Error bit may be checked to make sure that the PALL command terminated without error.

Be sure that the printer or plotter has been completely configured before using these commands.

- PRSC** The PRSC command will print the currently displayed screen to a printer attached to the rear panel parallel printer port. This function is the same as the [PRINT] key. The printer type needs to be configured before using the PRSC command.
- PALL** The PALL command generates a plot of the entire screen. Each feature uses the pen assigned in the Setup Plotter menu.
- PTRC** The PTRC command plots only the data trace.
- PCUR** The PCUR command plots the cursor markers if the cursor is presently displayed on the screen.

DATA ACQUISITION CONTROL COMMANDS

- SSCN** The SSCN command has the same effect as pressing the [START] key. The SSCN command only has an effect when the unit is paused or clear.
- PAUS** The PAUS command pauses a scan in progress. If a scan is not in progress, the PAUS command is ignored. This is the same as pressing the [STOP] key while a scan is in progress. The unit will be in the PAUSE state.
- CLRS** The CLRS command resets the unit to the CLEAR state. All data accumulated will be lost and reset to zero. The CLRS command may be used at any time, even while a scan is in progress. The effect is the same as pressing the [STOP] key twice in succession.
- SCAN?** The SCAN? query reads the number of records which have been accumulated so far. A host program can use the SCAN? query to determine when a scan is finished. (The status bytes may also be used).

DATA TRANSFER COMMANDS

BINA? {i}

The BINA? query reads the display memory record data in ASCII format. If the parameter *i* is included, only the value of the data in bin #*i* is returned. The first bin is *i*=0 and the last bin is *i*=bins/record-1. If the parameter *i* is omitted, then the entire record of data is returned. In this case, data is sent continuously starting with bin #0 and ending with the last bin in the record (bins/record -1). Each data point is separated by a comma and the last data point is followed by a line-feed (GPIB) or carriage return (RS232). This format is convenient when using DMA driven host interfaces.

If BINA? is used to transfer the entire record over the RS232 interface, the host computer interface should be interrupt driven or have fast data communication routines since the data transmission is limited only by the baud rate.

If BINA? is used to transfer the entire record while the unit is BUSY and a scan is in progress, the entire record will be transferred before the display memory buffer is updated. The data acquisition memory will continue to acquire data at the trigger rate and will be transferred to the display buffer when the BINA? transfer is complete.

BINB?

The BINB? query reads the entire display memory data record in binary format over the GPIB interface. The BINB? command is not available over the RS232 interface. The BINB? command may only be used if the data is integer count data. If the data has been converted to floating point, BINB? will cause an error.

BINB? returns the entire data record, 2 bytes per bin starting with bin #0 and continuing to the last bin in the record. There is no separation between data points. A line-feed follows the last data point. Each data point is sent low byte first, then high byte. The 2 bytes represent the data point in 16 bit 2's complement format.

When using the BINB? command, the host interface must be capable of binary transfer, i.e. accepting line feeds and carriage returns as data rather than terminators. In addition, the host program must read exactly the correct number of bytes (number of bins per record times 2 plus the last line-feed).

If BINB? is used while the unit is BUSY and a scan is in progress, the entire record will be transferred before the display memory buffer is updated. The data acquisition memory will continue to acquire data at the trigger rate and will be transferred to the display buffer when the BINB? transfer is complete.

INTERFACE CONTROL COMMANDS

- *RST** The *RST command resets the SR430 to its default configurations. The communications setup is not changed. All other modes and settings are set to their default conditions and values.
- *IDN?** The *IDN? query returns the SR430's device identification string. This string is in the format "Stanford_Research_Systems,SR430,s/n00001,ver007". In this example, the serial number is 00001 and the firmware version is 007.
- LOCL i** The LOCL command sets the RS232 local/remote function. If i=0 the SR430 is LOCAL, if i=1 the SR430 will go REMOTE, and if i=2 the SR430 will go into LOCAL LOCKOUT state. The states duplicate the GPIB local/remote states. In the LOCAL state both command execution and keyboard input are allowed. In the REMOTE state command execution is allowed but the keyboard and knob are locked out except for the [HELP] key which returns the SR430 to the LOCAL state. In the LOCAL LOCKOUT state all front panel operation is locked out, including the [HELP] key.

STATUS REPORTING COMMANDS

The Status Byte definitions follow this section.

- *CLS** The *CLS command clears all status registers.
- *ESE (?) {i}** The *ESE i command sets the standard status byte enable register to the decimal value i (0-255). The *ESE? command queries the value of the status byte enable register.
- *ESR? {i}** The *ESR? query reads the value of the standard status byte. The value is returned as a decimal number from 0 to 255. If the parameter i (0-7) is included, the value of bit i is returned. Reading the entire byte will clear it while reading bit i will clear just bit i.
- *SRE (?) {i}** The *SRE i command sets the serial poll enable register to the decimal value i (0-255). The *SRE? command queries the value of the serial poll enable register.
- *STB? {i}** The *STB? query reads the value of the serial poll byte. The value is returned as a decimal number from 0 to 255. If the parameter i (0-7) is included, the value of bit i is returned. Reading this byte has no effect on its value.
- *PSC (?) {i}** The *PSC command sets the value of the power-on status clear bit. If i=1 the power-on status clear bit is set and all status registers and enable registers are cleared on power up. If i=0 the bit is cleared and the status enable registers maintain their values at power down. This allows the a service request to be generated at power up.
- ERRE (?) {i}** The ERRE command sets the error status enable register to the decimal value i (0-255). The ERRE? command queries the value of the error status enable register.

Remote Programming

ERRS? {i}	The ERRS? query reads the value of the error status byte. The value is returned as a decimal number from 0 to 255. If the parameter i (0-7) is included, the value of bit i is returned. Reading the entire byte will clear it while reading bit i will clear just bit i.
MCSE (?) {i}	The MCSE command sets the multichannel scaler (MCS) status enable register to the decimal value i (0-255). The MCSE? command queries the value of the MCS status enable register.
MCSS? {i}	The MCSS? query reads the value of the multichannel scaler (MCS) status byte. The value is returned as a decimal number from 0 to 255. If the parameter i (0-7) is included, the value of bit i is returned. Reading the entire byte will clear it while reading bit i will clear just bit i.

STATUS BYTE DEFINITIONS

The SR430 reports on its status by means of four status bytes: the serial poll byte, the standard status byte, the MCS status byte, and the error status byte.

Upon power-on, the SR430 may either clear all of its status enable registers or maintain them in the state they were in on power-down. The *PSC command determines which action will be taken.

SERIAL POLL STATUS BYTE	<u>bit</u>	<u>name</u>	<u>usage</u>
	0	Scan Ready	No scan (data acquisition) in progress
	1	Interface Ready	No command execution in progress
	2	Error	An unmasked bit in the error status byte has been set
	3	MCS	An unmasked bit in the MCS status byte has been set
	4	MAV	The interface output buffer is non-empty
	5	ESB	An unmasked bit in the standard status byte has been set
	6	SRQ	SRQ (service request) bit
	7	Unused	

The Error, MCS, and ESB bits are set whenever any unmasked bit in their respective status registers is set. A bit is unmasked by setting the corresponding bit in the corresponding enable register. The Serial Poll Status bits are not cleared until the condition which set the bit is cleared. Thus, these bits give a constant summary of the enabled status bits. A service request will be generated whenever an unmasked bit in the Serial Poll register is set. Note that service requests are only produced when the bit is first set and thus any condition will only produce one service request. Accordingly, if a service request is desired every time an event occurs the status bit must be cleared between events.

STANDARD EVENT STATUS BYTE	<u>bit</u>	<u>name</u>	<u>usage</u>
	0	Input Error	Set on input queue overflow (too many com-

mands received at once, queues cleared)

1	Unused	
2	Query Error	Set on output queue overflow (too many responses waiting to be transmitted, queues cleared)
3	Unused	
4	Execution Error	Set when a command can not execute correctly or a parameter is out of range
5	Command Error	Set when an illegal command is received
6	URQ	Set by any key press or knob rotation
7	PON	Set by power-on

The Standard Event status byte is defined by IEEE-488.2 (1987) and is used primarily to report errors in commands received over the communications interfaces. The bits in this register remain set until cleared by reading them or by the *CLS command.

MCS STATUS BYTE

<u>bit</u>	<u>name</u>	<u>usage</u>
0	Triggered	Set when a record is triggered
1	Plot Complete	Set when a plot is completed
2	Print Complete	Set when a print screen operation is completed
3	Toggled	Set when the accumulate mode toggles between add and subtract
4	Scan Paused	Set when the unit enters the PAUSE state
5	Inhibited	Set when a record accumulation is inhibited via the rear panel Inhibit input.
6	Unused	
7	Unused	

The MCS Status bits stay set until cleared by reading or by the *CLS command.

Remote Programming

ERROR STATUS BYTE	<u>bit</u>	<u>name</u>	<u>usage</u>
	0	Plot Error	Set when an error occurs during plotting
	1	Print Error	Set when an error occurs during a print screen operation
	2	Memory Error	Set when a memory error is detected
	3	Disk Error	Set when an error occurs during a disk or file operation
	4	Unused	
	5	Clock Unlock	Set when the internal bin clock time base is not valid
	6	Rate Error	Set when a trigger arrives while the previous record is still being acquired or accumulated
	7	Overflow	Set when the count in any bin overflows during acquisition or accumulation

The Error Status bits stay set until cleared by reading or by the *CLS command.

FILE FORMATS

The formats of the files stored by the SR430 are described below. Disks written by the SR430 may be read on a MSDOS computer with a 3.5" disk drive. However, the files are not stored as ASCII files. They cannot be simply typed on the screen. The data is stored in binary format to keep the length of the files as short as possible.

In the following table, byte 0 refers to the first byte in the file. Integer and real number formats follow the Microsoft formats.

TRACE FILE	Byte	Type	Explanation
	0-11	ASCII character	The string "SR430_TRACE"<cr> appears at the beginning of the file
	12	2 byte integer	bin width (0-19) (see BWTH command)
	14-15		reserved
	16	2 byte integer	bins per record (1-16) (see BREC command)
	18-35		reserved
	36	4 byte real	minimum data value (if floating point data)
	40	4 byte real	range of data (if floating point data)
	44	4 byte integer	records accumulated
	48	2 byte integer	data point for bin 0
	50	2 byte integer	data point for bin 1

	continues until last data point in record.		

If the trace file represents integer count data, the data points are simply 2 byte integers which are the counts in each bin. If the file was saved as floating point data (after a CALC function), then the data is stored differently. Each data point is stored as a 2 byte integer which can be converted into the correct floating point value as follows.

$$\text{Float Value} = (\text{Integer data point}/65,536) \times (\text{range of data}) + (\text{minimum data value})$$

SETTINGS FILE	Byte	Type	Explanation
	0-11	ASCII character	The string "SR430_SET "<cr> appears at the beginning of the file
	12	2 byte integer	bin width (0-19) (see BWTH command)
	14-15		reserved
	16	2 byte integer	bins per record (1-16) (see BREC command)
	18	2 byte integer	Trigger Offset
	20	2 byte integer	Records per Scan
	22	4 byte integer	records accumulated
	26	2 byte integer	Trigger Level/.001V
	28-29		reserved
	30	2 byte integer	Discriminator Level/.0002V
	32-35		reserved
	36	2 byte integer	Toggle Count
	38-39		reserved
	40	2 byte integer	AUX 1 Level/.005 V
	42	2 byte integer	AUX 2 Level/.005 V

PROGRAM EXAMPLES

IBM PC, IBM BASIC using the RS232 interface

In this example, the IBM PC serial port COM1: is used at 9600 baud. Configure the SR430 to 9600 baud, 8 bits, no parity before running the program.

To read the data record over the RS232 interface, the BINA? n command is used to read points individually. Binary transfer is not supported over the RS232 interface, all data is transmitted in ASCII format.

```
10 ' EXAMPLE PROGRAM USING BASIC AND THE COM1 SERIAL PORT
20 ' THIS PROGRAM ASSUMES THAT A TTL TRIGGER SOURCE IS CONNECTED TO THE TRIGGER IN-
PUT
30 '
40 OPEN "COM1:9600,n,8,2,CS,DS,CD" AS #1
50 '
60 WRT$="OUTP 0"           ' DIRECT SR430 OUTPUT TO RS232 PORT
70 PRINT #1, WRT$
80 '
90 WRT$="BREC 1"           ' SET RECORD LENGTH TO 1024 BINS
100 PRINT #1, WRT$
110 '
120 WRT$="TRLV .5"         ' SET TRIGGER LEVEL TO .5 V
130 PRINT #1, WRT$
140 '
150 WRT$="TRLV?"           ' QUERY TRIGGER LEVEL
160 PRINT #1, WRT$
170 INPUT #1, TL           ' INPUT TRIGGER LEVEL
180 PRINT "Trigger Level ="; TL ' PRINT TRIGGER LEVEL
190 '
200 WRT$="CLRS"            ' RESET DATA MEMORY
210 PRINT #1, WRT$
220 '
230 WRT$="SSCN"            ' START SCAN WITH NEXT TRIGGER
240 PRINT #1, WRT$
250 '
260 WRT$="*STB?"           ' READ SERIAL POLL STATUS BYTE
270 PRINT #1, WRT$
280 INPUT #1, SP%
290 IF SP% MOD 2 = 0 GOTO 270 ' WHILE SCAN IS IN PROGRESS
300 '
310 FOR I=1 TO 1024 STEP 1 ' READ 1024 DATA POINTS
320 PRINT #1, "BINA?"; I-1 ' USING BINA?
330 INPUT #1, BIN
340 PRINT I, BIN
350 NEXT I
360 '
400 STOP
```

IBM PC, Microsoft C V5.1 using the National Instruments GPIB interface.

To successfully interface the SR430 to a PC via the GPIB interface, the instrument, interface card, and interface drivers must all be configured properly. To configure the SR430, the GPIB address must be set in the SETUP menu. The default GPIB address is 8; use this address unless a conflict occurs with other instruments in your system. The SR430 will be set to GPIB address 8 whenever a reset is performed (power on with the [CLR] key down).

Make sure that you follow all the instructions for installing the GPIB card. The National Instruments card cannot be simply unpacked and put into your computer. To configure the card you must set jumpers and switches on the card to set the I/O address and interrupt levels. You must run the program "IBCONF" to configure the resident GPIB driver for your GPIB card. Please refer to the National Instruments manual for information. In the example below, the SR430 is installed as a device named "mcs".

Once all the hardware and GPIB drivers are configured, use "IBIC". This terminal emulation program allows you to send commands to the SR430 directly from your computer's keyboard. If you cannot talk to the SR430 via "IBIC", then your programs will not run.

Use the simple commands provided by National Instruments. Use "IBWRT" and "IBRD" to write and read from the SR430. After you are familiar with these simple commands, you can explore more complex programming commands.

Binary Transfer Speed

The example program uses the BINB? binary data dump command to transfer data from the SR430 to the PC. Using a 12 MHz AT, a 16k record takes 0.8 second to transfer to the PC.

```
/* Example program using Microsoft C V5.1 and the National Instruments GPIB card */
/* This program assumes that a TTL trigger source is connected to the TRIGGER input */
/* This program assumes that the SR430 is installed as device "mcs" using IBCONF */
```

```
#include<stdio.h>
#include<dos.h>
#include<conio.h>
#include<stdlib.h>

#include"decl.h"          /* National Instruments Header File */

void main(void);

int  ibfind(char *);      /* Function Prototypes for GPIB Calls */
void ibwrt(int,char *,int);
void ibrd(int,char *,int);
void ibrda(int,char *,int);
void ibwait(int,int);
void ibstop(int);
void ibrsp(int,int *);

void main(void)
{
int i;
int sr430;
int sp;
int buff[2000];
char tstr[20];
```

Program Examples

```
if ( (sr430=ibfind("mcs"))<=0 ) { /* Find Device */
    printf("Cannot Find Device MCS\n");
    exit(0);
}

ibwrt(sr430,"OUTP 1",6); /* Direct SR430 output to GPIB interface */
ibwrt(sr430,"BREC 1",6); /* Set Record Length to 1024 Bins */
ibwrt(sr430,"TRLV .5",7); /* Set Trigger Level to .5 Volts */
ibwrt(sr430,"TRLV?",5); /* Query Trigger Level */
ibrd(sr430,tstr,20);
tstr[ibcnt]=0; /* Terminate Received String */
printf("Trigger Level = %s\n",tstr);

ibwrt(sr430,"CLRS",4); /* Reset SR430 to Clear state (clear data memory) */
ibwrt(sr430,"SSCN",4); /* Start Scan (next trigger starts scan) */

do {
    ibrsp(sr430,&sp); /* Check Status using serial poll */
}
while (!(sp&1)); /* While Scan is still in progress */

ibwrt(sr430,"BINB?",5); /* Dump the Scan */
ibrd(sr430,(char *)buff,2048); /* Read 2048 bytes back from SR430 (each point is 2 bytes) */

for (i=0; i<1024; i++) /* Print data record to screen */
    printf("Bin = %d Count= %d\n",i,buff[i]);

printf("Program Executed Normally\n");
}
```

IBM PC, IBM BASIC using the National Instruments GPIB interface.

Refer to the previous example for a discussion about the National Instruments GPIB interface.

This BASIC program does exactly the same thing as the C program in the previous example. Be sure to use the file DECL.BAS provided by National Instruments to start your program. DECL.BAS contains the initialization procedures for the GPIB driver.

```

10 ' EXAMPLE PROGRAM USING MICROSOFT BASIC AND THE NATIONAL INSTRUMENTS GPIB CARD
20 ' THIS PROGRAM ASSUMES THAT A TTL TRIGGER SOURCE IS CONNECTED TO THE TRIGGER IN-
PUT
30 ' THIS PROGRAM ASSUMES THAT THE SR430 IS INSTALLED AS DEVICE MCS USING IBCONF
40 '
50 ' USE THE FILE DECL.BAS PROVIDED BY NATIONAL INSTRUMENTS TO INITIALIZE THE GPIB DRIV-
ER
60 '
100 CLEAR ,60000! : IBINIT1=60000! : IBINIT2=IBINIT1+3 : BLOAD "bib.m",IBINIT1
110 CALL IBINIT1(IBFIND, IBTRG, IBCLR, IBPCT, IBSIC, IBLOC, IBPPC, IBNA, IBONL, IBRSC, IBSRE,
IBRSV, IBPAD, IBSAD, IBIST, IBDMA, IBEOS, IBTMO, IBEOT, IBRDF, IBWRTF, IBTRAP)
120 CALL IBINIT2(IBGTS, IBCAC, IBWAIT, IBPOKE, IBWRT, IBWRTA, IBCMD, IBCMDA, IBRD, IBRDA,
IBSTOP, IBRPP, IBRSP, IBDIAG, IBXTRC, IBRDI, IBWRTI, IBRDIA, IBWRTIA, IBSTA%, IBERR%, IBCNT%)
130 '
140 ' DONE WITH DECL.BAS
150 '
160 ' OUR PROGRAM STARTS HERE
170 BDNAMES$="MCS"
180 CALL IBFIND(BDNAMES$, SR430%) ' FIND SR430
190 IF SR430% < 0 GOTO 1000
200 '
210 WRT$="OUTP 1" ' DIRECT SR430 OUTPUT TO GPIB INTERFACE
220 CALL IBWRT(SR430%, WRT$)
230 '
240 WRT$="BREC 1" ' SET RECORD LENGTH TO 1024 BINS
250 CALL IBWRT(SR430%, WRT$)
260 '
270 WRT$="TRLV .5" ' SET TRIGGER LEVEL TO .5 VOLTS
280 CALL IBWRT(SR430%, WRT$)
290 '
300 WRT$="TRLV?" ' QUERY TRIGGER LEVEL
320 CALL IBWRT(SR430%, WRT$)
330 '
350 S$=SPACE$(20) 'PRINT TRIGGER LEVEL RESPONSE
360 CALL IBRD(SR430%, S$)
370 PRINT "Trigger Level =";S$
380 '
390 WRT$="CLRS" ' CLEAR DATA MEMORY FOR NEW SCAN
400 CALL IBWRT(SR430%, WRT$)
410 '
420 WRT$="SSCN" ' START SCAN WITH NEXT TRIGGER
430 CALL IBWRT(SR430%, WRT$)
440 '
450 CALL IBRSP(SR430%, SP%) ' CHECK STATUS USING SERIAL POLL
460 IF SP% MOD 2 = 0 GOTO 450 ' WHILE SCAN IS IN PROGRESS
470 '
480 WRT$="BINB?"
490 CNT%=2048
500 DIM BUF% (2000)

```

Program Examples

```
510 '  
520 CALL IBWRT(SR430%, WRT$)      ' SEND BINB? COMMAND TO BINARY DUMP THE DATA  
530 '  
540 CALL IBRDI(SR430%, BUF%(0), CNT%) ' READ 2048 BYTES INTO INTEGER ARRAY BUF%  
550 '  
560 FOR I=1 TO 1024 STEP 1        ' PRINT DATA RECORD TO SCREEN  
570 PRINT I, BUF%(I)  
580 NEXT I  
590 '  
600 STOP  
1000 PRINT "CANNOT FIND DEVICE MCS"  
1010 STOP
```

TEST AND CALIBRATION

POWER

To start, make sure that the power entry module on the rear panel is set for the ac line voltage in your area and that the correct fuse is installed. The selected ac voltage may be seen through the window on the power entry module. Verify that the line cord is plugged all the way into the power entry module and that the power button on the front panel is pressed in.

SCREEN BRIGHTNESS

If the screen is too dark or too bright, adjust the brightness using the knob at the upper left of the screen. Do not set the brightness higher than necessary.

DISPLAY POSITION

Use the Setup Screen function in the SETUP menu to position the display in the center of the screen.

FAN

The fan in the SR430 is temperature controlled. When the unit is cold, the fan is at half speed. When the internal temperature reaches about 30° C, the fan speed increases. Do not block the vents in the chassis or the unit may not operate properly.

FRONT PANEL TESTS

The keypad, knob, disk drive, screen, and memory may be tested using the Test menu. See the Test menu section for a complete description of the tests.

POWER ON RESET

If the instrument turns on with odd settings, an incorrect or blank screen display, or is unresponsive to the keypad or knob, then the memory contents may have been corrupted causing the instrument to "hang". To remedy the situation, turn the unit off and hold down the [CLR] key while turning the unit back on. This causes the unit to reinitialize the memory and assume the default setup.

TESTING THE DATA ACQUISITION HARDWARE (COUNTERS, MEMORY, AND ACCUMULATOR)

Unplug all cables from the unit and recall the default setup by holding the [CLR] key down while turning the unit on.

This test requires a simple TTL rate generator to trigger the SR430. The rate generator output should be attached to the TRIGGER input of the SR430. The trigger rate should be variable up to 2 kHz. Set the Trigger Level and Slope to trigger on the generator output.

The rear panel TEST output is used as the source of signal pulses. The TEST output is a 50 , NIM level output at 50 MHz. The pulses are synchronous with the BIN CLK and thus a known number of pulses will occur within each bin.

Use a BNC cable to connect the TEST output to the SIGNAL input on the front panel. Set the Discriminator Level to -300.0 mV and the Discriminator Slope to Negative.

In the Mode menu, select a Bin Width of 40 ns and set the Bins/Record to 1k. Set the Records/Scan to 1000. Set the TTL rate generator to a frequency of 1 kHz.

Press the [START] key to begin acquiring data. The 1000 records should require 1 second to acquire. The Status indicator should display Trigd and BUSY for the 1 second. There should not be a RATE error since the record time is $1024 \times (40 \text{ ns} + 250 \text{ ns}) + 150 \text{ } \mu\text{s}$ or $450 \text{ } \mu\text{s}$ and the trigger period is 1 ms.

When data acquisition is complete, the Status indicator should display DONE. Use the [AUTO-SCALE] key to scale the display. In each record, each 40 ns bin will count 2 pulses (the TEST pulse period is 20 ns) and 1000 records will accumulate 2000 counts in each bin. The first bin is an exception. The first bin always counts one less than the rest of the bins and so will have 1000 counts in it. Use the display and cursor to verify that the data is correct. If there is some variation from bin to bin, that may be because the cable connecting the TEST output to the SIGNAL input delays the test pulses such that they always occur right on a bin boundary. In that case, even though no counts are lost, there will be some variation as to which bin each pulse goes into. Use a slightly longer cable, or add a short length of cable to delay the pulses away from the bin boundaries. In either case, the total number of counts should be correct.

Clear the data using the [STOP] key. Select a bin width of 5 ns. Press the [START] key to accumulate 1000 records again. In this case, only every

Test and Calibration

4th bin will have counts in it. This is because the TEST pulses come every 20 ns. When the data acquisition is DONE, every 4th bin should have 1000 counts in it. Once again, if the pulses are landing on the bin boundaries, add a short length of cable to delay the pulses. Also, adding cable delay to the TEST cable can also move the pulses into new bins. In this way, every bin can be tested eventually.

Once these tests are completed, any bin width up to 327 μ s and any record length can be tested. Remember that the TEST pulses come every 20 ns and that the first bin will always receive 1 less count per trigger than the rest of the bins. Also, for longer record times, the 1 kHz trigger rate will be too fast and generate RATE errors. These may either be ignored or the trigger rate lowered. Each bin can only count up to 32767 in a single trigger so bins wider than 327 μ s will overload in a single trigger. The wider the bin, the less accumulation is allowed. Adjust the Records/Scan accordingly.

If problems are encountered, a scope should be used to verify that SYNC/BUSY, BIN CLK OUT, and DISC OUT are functioning properly. Set the Records/Scan to 0 and start data acquisition. Records will acquire without end allowing these signals to be examined at length.

The SYNC/BUSY output is a TTL level signal which goes high 45 ns after the trigger is received. The signal goes low after the record is acquired and accumulated. This time is equal to $N \times (\text{bin width} + 250 \text{ ns}) + 150 \mu\text{s}$ where N is the number of records per bin. Terminate this output into a high impedance.

The BIN CLK OUT is a NIM level 50 clock signal which indicates the bin boundaries. Each transition of the BIN CLK OUT is a bin boundary. The BIN CLK is active only while during the record acquisition time ($N \times \text{bin width}$). Terminate this signal into 50 Ω .

The DISC OUT is a NIM level 50 signal which indicates that the discriminator has detected a pulse. When using the TEST signal, the DISC OUT should be a 50 MHz signal. Terminate this signal into 50 Ω .

If all signals check out and problems still exist, contact the factory for more information.

COUNTING PROBLEMS

There are several reasons why the SR430 may not seem to be counting correctly.

1)Bad triggering. The trigger input may not be dis-

criminated correctly. To check the trigger slope and level, set the Records/Scan to 0 and press [START]. Records will be triggered indefinitely. Check the SYNC/BUSY output on a scope. This signal only occurs after a trigger is recognized and lasts only for the record acquisition and accumulation time. Check that the TRIGD indicator on the screen flashes for each trigger.

2)Incorrect discriminator levels or slopes. Verify that the discriminator settings are correct. Use the DISC output to check the discriminator output pulses on an oscilloscope.

3)Signal inputs are overloaded. Check that the inputs are $<\pm 300$ mV or, if the signal exceeds 300 mV, that the overloads do not last longer than 10 μ s. If the overload lasts longer than 10 μ s, the input amplifiers will not recover for about 200 ns.

4)Incorrect bin width. Check that the bin width is set correctly. A too narrow bin will result in smaller data points, a too wide bin may overload before expected.

5)The bin clock source is set to External. In this case the EXT BIN CLK input controls the bin timing. If there is no input to the EXT BIN CLK, there will be no bins.

6)Accumulation mode incorrect. Check that the accumulation is not toggling or externally controlled. If accumulation is set to external, check that the SUBTRACT input is receiving a valid TTL signal at the correct time.

7)Accumulation is inhibited. If the INHIBIT input is being driven, accumulation may be inhibited. In this case, no records accumulate.

CALIBRATION

Most of the calibration parameters are determined by a computer aided calibration procedure after burn-in at the factory. These calibration parameters are stored in the permanent memory of each unit. The calibration mainly involves setting the analog thresholds and levels accurately.

This section details the calibration of the signal inputs which, because of their high speed, require some hand adjustment. In addition, the repair procedure for the signal inputs is discussed.

CAUTION

See the diagram at the beginning of the circuit description to locate the circuit boards inside the chassis.

ALWAYS disconnect the power cord and wait at least two minutes before opening the unit. Dangerous power supply voltages may be present even after the unit has been unplugged.

Check the LED at the front edge of the power supply board. The unit is safe only if the LED is OFF. If the LED is ON, then STAY AWAY from the power supply board.

This unit is to be serviced by qualified service personnel only.

WARNING

The calibration procedure requires adjusting the instrument with power applied and so there is a risk of personal injury or death by electric shock. Stay away from the power supply board while the unit is plugged in.

Please be careful.

Turn the power off, disconnect the power cord, wait two minutes, then remove the top cover of the chassis. Plug the unit back in and turn on the power.

SIGNAL INPUT OFFSET

To calibrate the input offset, connect a voltmeter to the signal input. P101 adjusts the voltage which is output from the signal input. This output voltage should be set to 0V. The potentiometer is located on the ECL board (lower board) behind the signal input BNC. Use a small screwdriver from the top and adjust the potentiometer for a reading of 0 ± 0.1 mV on the meter.

SIGNAL INPUT REPAIR

The diodes in the overload protection circuit can be damaged by excessive voltages at the inputs. To check for damage, measure for 0.6 V across the diodes in D101. D102 and D103 can be tested by removing them from the circuit and then checking for degradation of the amplifier's pulse response as each diode is reconnected. The amplifier outputs can be viewed with a fast oscilloscope across R239. Replacement diodes are available from the factory.

Performing these adjustments or replacements can result in the discriminator levels being slightly miscalibrated. The discriminator offsets may be a few mV larger after repair or adjustment.

Remove the power cord and wait two minutes before replacing the cover. This allows the power supply to discharge and removes the possibility of shorting out a circuit with the cover while replacing it.

USING PHOTOMULTIPLIER TUBES

PHOTOMULTIPLIER SELECTION FOR PHOTON COUNTING

Photomultiplier Tubes (PMT's) are high-gain, low noise light detectors. They can detect single photons over a spectral range of 180 to 900 nm. Windowless PMT's can be used from the near UV through the X ray region, and may also be used as particle detectors.

Photons which strike the PMT's photocathode eject an electron by the photoelectric effect. This electron is accelerated toward the first dynode by a potential of 100 to 400 Vdc. Secondary electrons are ejected when the electron strikes the first dynode, and these electrons are accelerated toward the second dynode. The process continues, typically for 10 dynodes, each providing an electron gain of about 4, to produce 1,000,000 electrons which are collected by the anode. If these electrons arrive in a 5 ns pulse into a 50 Ohm load, they will produce a 1.6 mV pulse. These pulses may be amplified and counted.

GEOMETRY

There are two basic geometries for photomultiplier tubes: head-on and side-on types. The head-on type has a semitransparent photocathode, and a linear array of dynodes. The head-on types offer large photocathodes with uniform sensitivity, and lower noise. These PMT's must be operated at a higher voltage, and are usually larger and more expensive than the side-on types. Side-on types have an opaque photocathode and a circular cage of dynodes.

SPECTRAL RESPONSE

There are a variety of materials which are used as photocathodes: the workfunction of the photocathode will determine the spectral response (and will influence the dark count rate) of the PMT. For photon counting, the figure of merit is the "quantum efficiency" of the PMT. A 10% quantum efficiency indicates that 1 in 10 photons which strike the photocathode will produce a photoelectron -- the rest of the incident photons will not be detected. The quantum efficiency is a function of wavelength, so select the PMT for the best quantum efficiency over the wavelength region of interest.

GAIN AND RISE TIME

It is important to select a PMT with sufficient gain, and short enough risetime, to produce a detectable pulse for counting. In addition, the risetime is an important figure of merit to determine the maximum count rate for the tube.

The criteria for a "detectable pulse" depends on the electrical noise environment of your laboratory, and the noise your preamplifier. In laboratories with Q-switched lasers or pulsed discharges, it is difficult to reduce the noise on any coax cable below a few millivolts. A good, wide bandwidth preamplifier (such as the SR430) will have about 1.5 nV per root Hertz, or about 25 μ V rms over its 250 MHz bandwidth. Peak noise will be about 2.5 times the rms noise, and so it is important that the PMT provide pulses of at least 100 μ V amplitude.

Use manufacturer's specifications for the current gain and risetime to estimate the pulse amplitude from the PMT:

$$\text{Amplitude (mV)} = 4 \times \text{Gain (in millions)} / \text{Risetime (in ns)}$$

This formula assumes that the electrons will enter a 50 Ohm load in a square pulse whose duration is twice the risetime. (Since the risetime will be limited to 1.2 ns by the 300 MHz bandwidth of the preamplifier, do not use risetimes less than 1.5 ns in this formula.)

The current gain of a PMT is a strong function of the high voltage applied to the PMT. Very often, PMT's will be operated well above the high voltage recommended by the manufacturer, and so at substantially higher current gains (10x to 100x above specs). There are usually no detrimental affects to the PMT so long as the anode currents are kept well below their rated values.

Conclusions: Select a PMT with a risetime < 3 ns and a current gain > 5 million.

DARK COUNTS

PMT's are the quietest detectors available. The primary noise source is thermionic emission of electrons from the photocathode and from the first few dynodes of the electron multiplier. PMT housings which cool the PMT to about -20° C can dramatically reduce the dark count (from a few kHz to a few Hz). The residual counts arise from radioactive decays of materials inside the PMT and from cosmic rays.

Using Photomultiplier Tubes

PMT's which are specifically designed for photon counting will specify their noise in terms of the rate of output pulses whose amplitudes exceed some fraction of a pulse from a single photon. More often, the noise is specified as an anode dark current. Assuming the primary source of dark current is thermionic emission from the photocathode, the dark count rate is given by :

$$\text{Dark Count (in kHz)} = 6 \times \frac{\text{Dark Current (in nA)}}{\text{Gain (in millions)}}$$

PMT BASE DESIGN

PMT bases which are designed for general purpose applications are not appropriate for photon counting. General purpose bases will not allow high count rates, and often cause problems such as double counting and poor plateau characteristics. A PMT base with the proper high voltage taper, bypassing, snubbing, and shielding is required for premium photon counting performance.

CAUTION: Lethal High Voltages are used in PMT applications. Use extreme caution when working with these devices. Only those experienced with high voltage circuits should attempt any of these procedures. Never work alone.

DYNODE BIASING

A PMT base provides bias voltages to the PMT's photocathode and dynodes from a single negative high voltage power supply. The simplest design consists of a resistive voltage divider, as shown in Figure A.

In this configuration the voltage between each dynode, and so the current gain at each dynode, is the same. Typical current gains are 3 to 4, and so there will typically be 3 to 4 electrons leaving the first dynode, with a variance of about 2 electrons. This large relative variance (due to the small num-

ber of ejected electrons) gives rise to a large variations in the pulse height of the detected signal. Since statistical fluctuations in pulse height are caused by the low gain of the first few stages of the multiplier chain, increasing the gain of these stages will reduce pulse height variations and so improve the plateau characteristics of the PMT. To increase the gain of the first few stages, the resistor values in the bias chain are tapered to increase the voltage in the front end of the multiplier chain. The resistor values are slowly tapered so that the electrostatic focusing of electrons in the multiplier chain is not adversely affected.

Current for the electron multiplier is provided by the bias network. Current drawn from the bias network will cause the dynode potentials to change, and so change the tube gain. This problem is of special concern in lifetime measurements. The shape of exponential decay curves will be changed if the tube gain varies with count rate. To be certain that this is not a problem, repeat the measurement at half the original intensity.

The problem of gain variation with count rate is avoided if the current in the bias network is about 20 times the output current from the PMT's anode.

Example: If a PMT is operated so that it gives 20 mV pulses of 5 ns duration into a 50 Ohm cable, then the average current at 50 MHz count rate will be 0.1 mA. If the bias resistors are chosen so that the chain current is $20 \times 0.1 \text{ mA} = 2 \text{ mA}$, then the PMT's gain will remain constant vs. count rate. If this PMT is operated at 2500 vdc, then the power dissipated in this base is 5 Watts.

There are a few other methods to avoid this problem which do not require high bias currents. These methods depend on the fact that the majority of the output current is drawn from the last few dynodes of the multiplier.

- (1) Replace the last few resistors in the bias chain

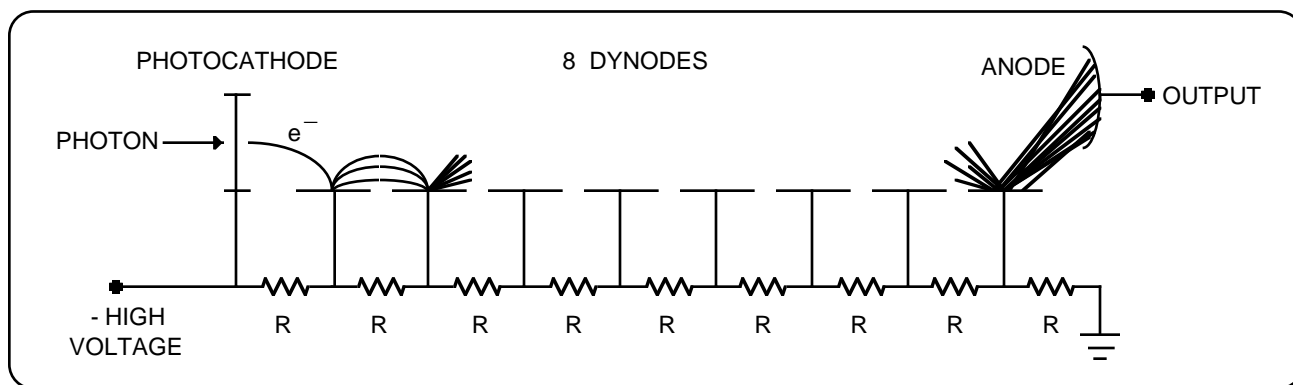

Figure A. Resistive Divider PMT Base

with Zener Diodes. As long as there is some reverse current through a Zener, the voltage across the diodes is nearly constant. This will prevent the voltage on these stages from dropping as the output current is increased.

(2) Use external power supplies for the last few dynodes in the multiplier chain. This approach dissipates the least amount of electrical power since the majority of the output current comes from lower voltage power supplies, however it is the most difficult to implement.

(3) If the average count rate is low, but the peak count rate is high, then bypass capacitors on the last few stages may be used to prevent the dynode voltage from dropping. (Use 20x the average output current for the chain current.) For a voltage drop of less than 1%, the stored charge on the last bypass capacitor should be 100x the charge output during the peak count rate. For example, the charge output during a 1 ms burst of a 100 MHz count rate, each with an amplitude of 10 mV into 50 Ohms and a pulse width of 5 ns, is 0.1 μ C. If the voltage on the last dynode is 200 Vdc, then the bypass capacitor for the last dynode should have a value given by:

$$C = 100 \text{ Q/V} = 100 \times 0.1\mu\text{C} / 200\text{V} = 0.05 \mu\text{F}$$

The current from higher dynodes is smaller so the capacitors bypassing these stages may be smaller. Only the final four or five dynodes need to be bypassed, usually with a capacitor which has half the capacitance of the preceding stage. To reduce the voltage requirement for these capacitors, they are usually connected in series. (See Figure B)

By passing the dynodes of a PMT may cause high

frequency ringing of the anode output signal. This can cause multiple counts for a single photon. The problem is significantly reduced by using small resistors between the dynodes and the bypass capacitors, as shown in Figure B.

SNUBBING

Snubbing refers to the practice of adding a network to the anode of the PMT to improve the shape of the output pulse for photon counting applications. This 'network' is usually a short piece of 50 Ohm coax cable which is terminated into a resistor of less than 50 Ohms. There are four important reasons for using a snubber network:

(1) Without some dc resistive path between the anode and ground, anode current will charge the signal cable to a few hundred volts. When the signal cable is connected to a preamplifier or to a signal input, the stored charge on the cable may damage the front-end of the instrument. If you decide not to use a snubber network, please install a 100 kOhm resistor between the anode and ground to protect your instruments.

(2) The risetime of the output current pulse is often much faster than the falltime. A snubber network may be used to sharply reduce the falltime, greatly improving the pulse pair resolution of the PMT.

(3) Ringing (with a few nanosecond period) is very common on PMT outputs (especially if the final dynode stages are bypassed with capacitors). A snubber network may be used to cancel these rings which can cause multiple counts from a single photon.

(4) The snubber network will help to terminate re-

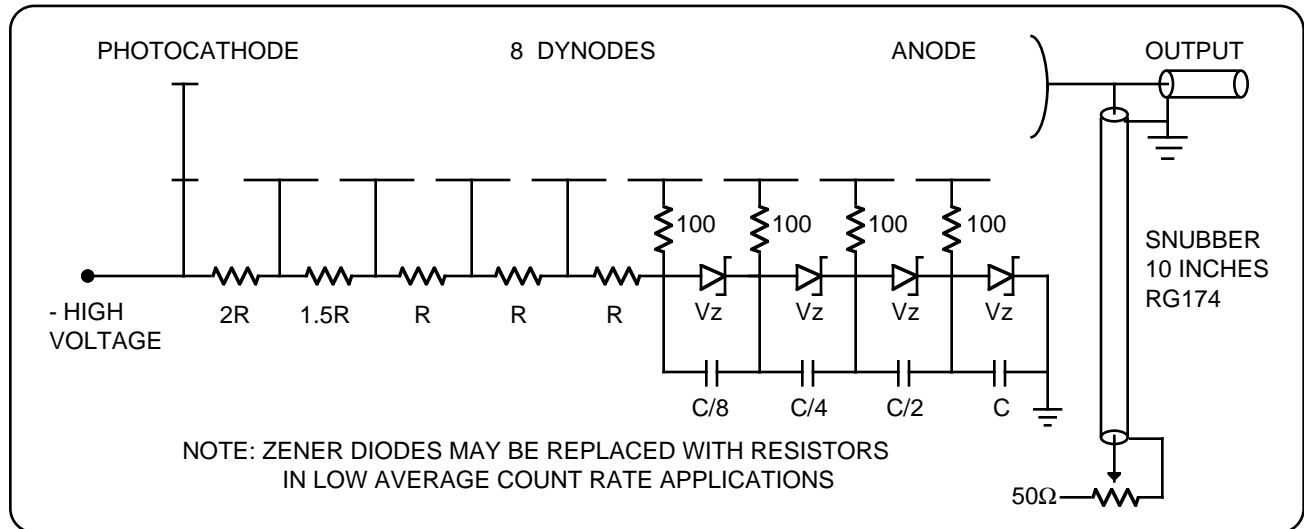

Figure B. PMT Base For Photon Counting

Using Photomultiplier Tubes

flections from the input to the preamplifier.

A good starting point for a snubber network is a 10 inch piece of RG174/U coax cable with a small 50 Ohm pot connected to the end so that the terminating impedance may be adjusted from 0 to 50 Ohms. (A 10 inch cable will have a round trip time of about 5 ns -- be sure your PMT has a risetime less than this.) The other end of this cable is connected to the anode of the PMT, together with the output signal cable.

Output current pulses will split, 50% going out the signal cable, and 50% going into the snubber. If the snubber pot is adjusted to 50 Ohms there will be no reflection -- the only affect the snubber has is to attenuate the signal by a factor of two.

The reflection coefficient for a cable with a characteristic impedance R_0 , terminated into a resistance R_t , is given by:

$$\text{Reflection Coefficient} = (R_t - R_0) / (R_t + R_0)$$

If the pot is adjusted to a value below 50 Ohms, then some portion of the signal will be inverted and reflected back toward the anode. This reflected (and inverted) signal is delayed by the round trip time in the snubber cable and sent out the signal cable. The amount of the reflection is adjusted for the best pulse shape as shown in the figure below.

The round trip time in the snubber cable may be adjusted so that the reflected signal cancels anode signal ringing. This is done by using a cable length with a round trip time equal to the period of the anode ringing.

PMT BASE CONCLUSIONS:

- (1) Taper voltage divider for higher gain in first stages.
- (2) Bypass last few dynodes in pulsed applications.
- (3) Use a snubber circuit to shape the output pulse.

CATHODE SHIELDING

Head-on PMT's have a semitransparent photocathode which is operated at negative high voltage. Use care so that no objects near ground potential contact the PMT near the photocathode.

MAGNETIC SHIELDING

Electron trajectories inside the PMT will be affected by magnetic fields. A field strength of a few Gauss can dramatically reduce the gain of a PMT. A magnetic shield made of a high permeability ma-

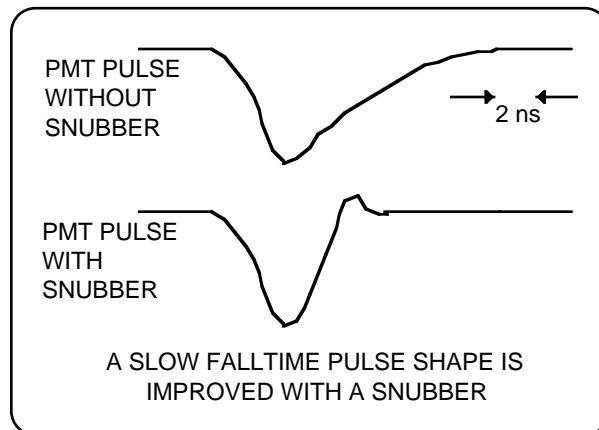

terial should be used to shield the PMT.

PREAMPLIFIERS

The output of a PMT is a current pulse. This current is converted to a voltage by a load resistor.

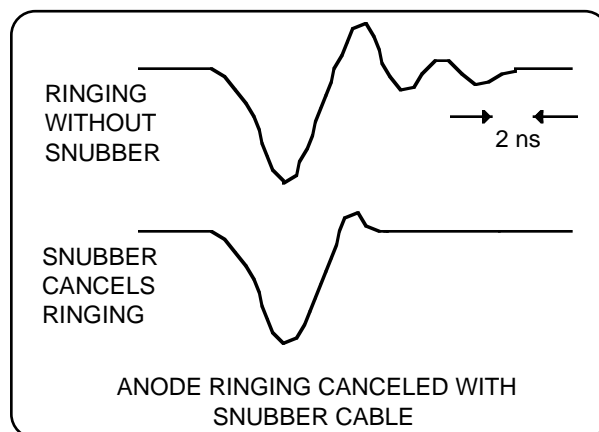

One would like to use a large resistor to get a large voltage pulse, however in photon counting it is important to maintain a high bandwidth for the output signal. Since charge on the anode is removed by the load resistance, smaller load resistances increase the bandwidth. The bandwidth of a 10 pF anode with a 100 Ohm load is 300 MHz.

For convenience, 50 Ohm systems are usually used. The current pulse from the PMT travels down a 50 Ohm cable which is terminated by the 50 Ohm input impedance of a preamplifier. The attenuation of RG-58 coax cable at 300 MHz is about 1 dB/ 10 ft. and so it does not significantly degrade performance in this application.

To allow counting to 200 MHz, a preamplifier with a bandwidth which is somewhat larger than 200

MHz is required. The SR440 preamplifier has four gain of 5 amplifiers, each with 50 Ohm input impedance and a 300 MHz bandwidth. The amplifiers may be cascaded for gains of 5, 25, 125, or 625.

GAIN REQUIREMENT

The SR430 can detect pulses as low as 2 mV. To allow for some adjustment of the discriminator threshold and to provide better noise immunity, a more practical lower limit on pulse size is about 10 mV. The highest discriminator level which may be set is 300 mV. The preamplifier should have enough gain to amplify anode pulses to between 10 mV and 300 mV (100 mV is a good target value).

Using the result that pulse height (in mV) is about 4x the tube gain (in millions) divided by the risetime (in ns), a PMT with a gain of 4 million and a risetime of 2 ns will provide 8 mV output pulses. Half of the pulse amplitude will be lost in the anode snubber, so a gain of 25 is required to boost the output pulses to 100 mV amplitude.

PLATEAUIING A PMT

Due to the statistical nature of the secondary emission process, there is a distribution of signal pulse heights coming from the PMT. There is another distribution of noise pulse heights. Noise which results from thermionic emission from the photocathode can not be distinguished from signal, however, noise pulses from dynode thermionic emission will have a lower mean pulse height. The PMT should be operated at sufficient high voltage that the mean signal pulse height is well above the pulse height of other noise sources such as preamp noise and EMI pickup.

There are two reasons for carefully selecting the input discriminator level. The first is to improve the signal-to-noise ratio by setting the discriminator level above most of the noise pulses, but below most of the signal pulses. The second reason is to reduce drift: if the discriminator threshold is set to the middle of the signal pulse height distribution, then small changes in the tube gain can cause a large change in the count rate.

There is no exact prescription for setting the discriminator threshold: the procedure used will depend somewhat on the nature of the measurement. If dark counts are a problem then the discriminator level should be set higher than when drift is a concern. If the PMT is cooled (reducing thermionic emission) then a lower discriminator level is probably okay. If the PMT has a ring on the anode signal then the discriminator level should be set high enough so that the rings are not counted.

THE 'FAST AND PRETTY GOOD' WAY

This technique works very well and is particularly suited for those who do not want to make a career out of plateauing their PMT's. The PMT should be operated at (or a bit above) the recommended maximum high voltage. Provide enough illumination for a count rate of a few megahertz, and enough preamp gain to get pulse heights of about 100 mV. Using a 300 MHz oscilloscope, adjust the snubber termination impedance for the best pulse shape. Look carefully at the anode pulse shape and set the discriminator to a level which is above any ringing, but well below the mean pulse height. If there is lots of EMI or amplifier noise then increase the PMT's high voltage to increase the signal pulse height.

Using Photomultiplier Tubes

TYPICAL EXPERIMENT

This experiment is typical of many time resolved photon counting experiments. A pulsed light source is used to pump atoms to an excited state. Fluorescent decay from the excited state are observed, allowing the lifetime of the state to be measured.

ENERGY LEVELS OF RUBY

The energy level diagram of Ruby is shown below. There are absorption bands around 400 nm and 550 nm. The Cr⁺⁺⁺ ions which absorb light at these wavelengths decay in about 50 ns to the upper state of the well known laser transition. This state has a lifetime of about 3.5 ms, and decays to the ground state by emitting a photon at 694.3 nm. The absorption band at 550 nm overlaps the emis-

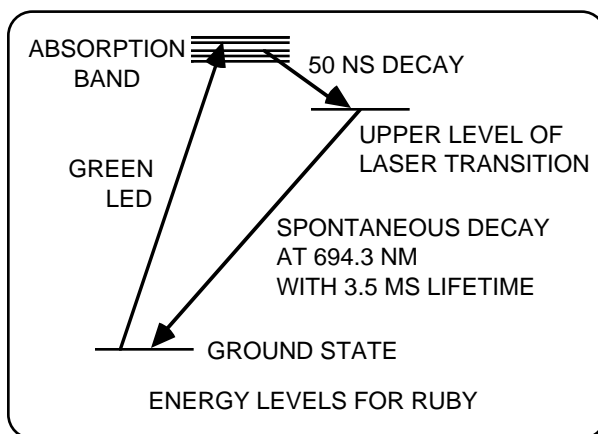

sion line of a green LED. In this demonstration experiment, a pulsed green LED is used to quickly populate the excited state, and decays from the excited state are seen through a bandpass inter-

ference filter centered on Ruby's 694.3 nm emission line.

APPARATUS

The apparatus is shown below. The green LED is glued to the edge of a 1 cm diameter, 3 mm thick, ruby disk. The ruby disk is viewed through the bandpass interference filter by a Hamamatsu R928 PMT. This side-on PMT was selected for its high gain, fast rise time, and good red sensitivity.

The phototube base uses a tapered voltage divider, with about 3x the normal interstage voltage between the photocathode and the first dynode. This helps to narrow the pulse height spectrum for single photon events. The lower dynodes are bypassed, and 100 Ohm resistors are used between the dynodes and their bypass capacitors to reduce ringing in the anode signal. A snubber network consisting of a 10 inch piece of RG174 terminated into 20 Ohms is used to further reduce anode ringing and reduce the falltime of the output current pulse.

OPERATION

The PMT is operated at the maximum rated high voltage (1250 Vdc). The output pulses have a mean amplitude of 20 mV into 50 Ohms. To increase the pulse height to 100 mV, one amplifier in the SR440 preamp provides a gain of 5 with a 300 MHz bandwidth. The discriminator threshold is set to 20 mV. When viewed with a 300 MHz oscilloscope, it is apparent that this threshold setting will count the majority of output pulses, but will not count anode rings or amplifier noise.

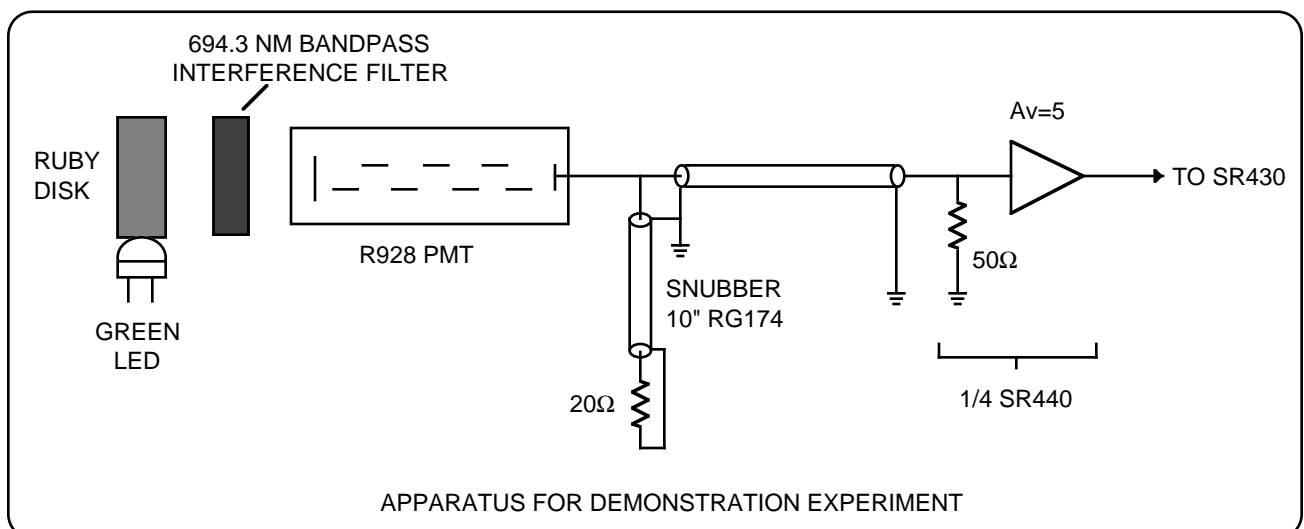

Typical Experiment

The green LED is flashed at a 40 Hz rate for about 1 ms. During this time, population integrates in the upper level of the laser transition. Spontaneous decays from the upper level are counted by the SR430.

INSTRUMENT CONFIGURATION

The multichannel scaler is triggered by the same pulse which flashes the LED. The bin width is 20.48 μ s and the record length is 1k bins. The records per accumulation is set to 100. Thus each record takes approximately 21 ms of real time to acquire which is sufficient to measure the 3.5 ms lifetime of the excited state. The pulse rate of 40 Hz will not generate rate errors. 100 records will take 2.5 sec to complete.

DATA ACQUISITION

After the SR430 Levels and Mode menus have been setup, data acquisition may begin. Pressing the [START] key starts the first record. Data accumulates on the screen until all 100 records have been acquired. When data acquisition is DONE,

the Math menu may be used to fit an exponential curve to the data to measure the lifetime directly.

Finally, the data curve is printed or plotted and stored to disk.

INSTRUMENT CONFIGURATION

Levels:	Trigger Level	+1.000 V	Trigger threshold set to +1.000V
	Trigger Slope	RISE	Trigger on rising edge of LED trigger
	Disc Level	-20.0 mV	Disc threshold set to -20.0 mV
	Disc Slope	FALL	Discriminate negative pulses
Mode:	Bin Clk Source	Internal	Internal bin time base
	Bin Width	20.48 μ s	20.48 μ s bins
	Bins/Record	1k	1024 bins/record
	Records/Scan	100	Accumulate 100 records
	Trigger Offset	0	Start data at bin #0
	Accumulate Mode	Add	Add all records to accumulation

SR430 CIRCUIT DESCRIPTION

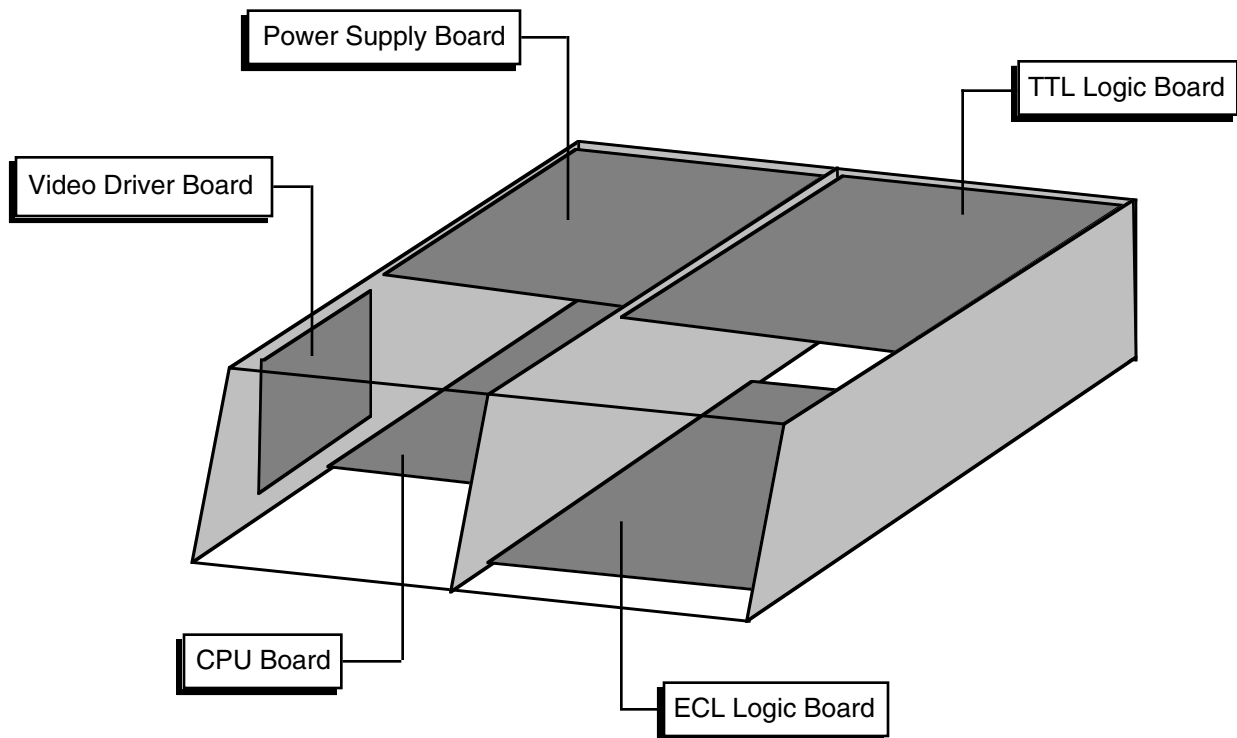

CAUTION

Always disconnect the power cord and wait at least two minutes before opening the unit. Dangerous power supply voltages may be present even after the unit has been unplugged.

Check the LED at the front edge of the power supply board. The unit is safe only if the LED is OFF. If the LED is ON, then DO NOT attempt any service on the unit.

This unit is to be serviced by qualified service personnel only. There are no user serviceable parts inside.

CIRCUIT BOARDS

The SR430 has five main printed circuit boards. The five boards shown above contain all of the active circuitry of the unit. A sixth, front panel circuit board (not shown), only has keypad contacts printed on it and holds no active components.

The five main boards are mounted with their component sides facing inward. All boards have a silk-screen printed on both sides to ease identification of parts.

Circuit Description

VIDEO DRIVER AND CRT

Potentially lethal voltages are present in this circuit. Do not attempt to service the CRT and Video Driver Board. Refer any service problems to the factory.

CPU BOARD

The CPU board contains the microprocessor system. All display, front panel, disk, and computer interfaces are on this board.

MICROPROCESSOR SYSTEM

The microprocessor, U101, is an 80C186 microcontroller which integrates a fast 16 bit processor, counter-timers, interrupt controller, DMA controller, and IO decoding into a single component.

The 80C186 uses a 24.00 MHz crystal, X101, as its oscillator. The instruction clock cycle is 2 oscillator cycles or 12.0 MHz. The data and lower 16 bits of address are multiplexed on AD0-AD15. U201, U202, U203 latch the address A0-A19 at the beginning of each memory or IO cycle. U204 and U205 are bidirectional data bus drivers which are active during the data read/write portion of each memory or IO cycle.

The 80C186 can address 1 Mbyte of memory and 64k of IO space. The memory is mapped into 4 256kbyte blocks. Each block can actually have 64k, 128k, or 256k of physical memory. Each block has 2 sockets, one for the low byte and one for the high byte of data.

U301 and U302 are 64kbyte EPROMS holding the program boot firmware. This memory is mapped at E0000H to FFFFFH (128k). U303 and U304 are data ROMS mapped at 80000H to 9FFFFH (128k).

U401 and U402 are 32kbyte CMOS static RAMs mapped at 00000H to 0FFFFH (64k). This memory is backed up by the battery. Q401 provides power down RAM protection. This memory is system memory.

U403 and U404 are also 32kbyte static RAMs. They are mapped at 40000H to 4FFFFH (64k) and are used as the display data memory. Up to 16k data points may be stored in this memory. Data stored in this memory may be graphed on the screen.

4 of the 7 80C186's peripheral chip select strobes are used by peripherals on the CPU board. -PCS0 is decoded into 16 IO strobes which access the clock, keypad, keyboard, knob, printer port, etc. -PCS1 decodes the disk controller, the GPIB controller, and DMA acknowledge strobes. -PCS2 selects the UART and -PCS3 selects the video graphics controller. Whenever the video controller is accessed, the ARDY line is asserted (U504A) which puts the processor into a wait state. When the video controller acknowledges the data transfer by pulling -Video_Rdy low, the ARDY line is de-asserted (U805A and U815D) and the processor moves on to the next instruction.

Interrupts generated by peripherals on the CPU board are combined in U505 into a single prioritized interrupt. The highest priority pending interrupt will be encoded on U505's outputs and read via the status port, U608. The UART directly interrupts the processor since it can never be masked.

KEYPAD INTERFACE

The keypad is organized as 8 columns and 8 rows of switch closures. The conductive rubber keys provide the switch closures. U607 strobes the columns and U606 detects the switch closure. The diodes D601 - D608 prevent one column from affecting another. All of the outputs from U607 are set high and U606 is read periodically by the processor. As long as 00H is read, no key is pressed and the strobes are left on. When a non-zero byte is read, then the key strobes are activated individually in order to decode which key is down.

KEYBOARD INTERFACE

The PC keyboard interface uses U603 to convert serial data from the keyboard into a parallel byte for the processor to read. The data format from the keyboard is a leading start bit followed by 8 data bits. U603 is reset by a processor read. When a key is pressed, the bits are shifted into U603. When the start bit appears at the QH output, 7 bits of the data byte are in U603. U601 is the 9th bit of the shift register. When U601 clocks in the start bit, U601 must have the 8 bits of the data. U601 then latches the serial data in U601 and interrupts the processor.

Only keyboards which operate in the PC or 8088 mode will function with this interface.

SPIN KNOB

The knob is an optical encoder buffered by U612. Each transition of its outputs is clocked into U610 or U611 and generates an interrupt at the output of U602A. The processor keeps track of the knob's position continuously.

SPEAKER

The speaker is driven by a timer on the 80C186. The timer outputs a square wave which is enabled by U602B and drives the speaker through Q705.

CLOCK/CALENDAR

U702 is an MC146818 real time clock chip which keeps track of time and date. The time base is a 32.768 kHz oscillator made by U706. Both U702 and U706 are battery backed up.

PRINTER INTERFACE

The printer interface allows screen displays to be printed to Epson compatible printers. Output data is buffered by U703, an LS octal latch. Output control bits are buffered by the open collector driver U704, and input control bits are discriminated by U705C and U705D.

VIDEO GRAPHICS INTERFACE

The video graphics interface is centered around U810, an HD63484 graphics controller. The HD63484 generates the video sync signals, controls the video memory, and draws graphic primitives such as lines, circles, polygons, etc., and other high level functions. The HD63484 relieves the 80C186 from having to calculate each video image and greatly increases display speed.

U813 and U814 are 32kbyte RAMs which make up the 64k video memory. The video screen is 640H by 480V and requires 38,400 bytes of memory. The remaining memory is used to store patterns, fonts, and other graphic objects. The data and address are multiplexed and U811 and U812 are the address latches.

Data is read 16 bits at a time. When data is required for the display, the 16 bits of data are

latched into U804 and U809 which are parallel to serial converters. The video data is then shifted out at 13.5 MHz and synchronized by U806B. U803C blanks the video data except during active display times.

Memory is accessed twice during each display cycle. The first access reads the 16 bits of video data for the current display cycle. The second access is used by the controller for drawing purposes. During the drawing access, data at any address may be read or written. This allows drawing to take place as fast as possible.

Commands and data are sent from the 80C186 to the HD63484 using a DMA channel. This allows the HD63484 to process commands without having to wait for the 80C186 to send them.

DISK CONTROLLER

U907 is a DP8473 disk controller which integrates all of the functions of the PC interface into a single IC. All motor controls, read and write signals, and data are all controlled by the DP8473. A DMA channel is used to send and receive data from the controller in order to satisfy the disk drive timing.

GPIB INTERFACE

The GPIB (IEEE-488) interface is provided by U902, a TMS9914A controller. U903 and U904 buffer data I/O to the GPIB connector. U902 is programmed to provide an interrupt to the processor whenever there is bus activity addressed to the unit.

RS232 INTERFACE

The SCN2641 UART, U905, provides all of the UART functions as well as baud rate generation. Standard baud rates up to 19.2k can be generated from the 3.6864 MHz clock. U906 buffers the outgoing data and control signals. Incoming signals are received by U705A and U705B. If the host computer asserts DTR, RS232 data output from the unit will cease.

The RS232 port is a DCE and may be connected to a PC using a standard serial cable (not a "null modem" cable).

EXPANSION CONNECTOR

All control of the data acquisition hardware is through the signals on the 2 40-pin expansion connectors.

POWER SUPPLY BOARD

CAUTION: Dangerous voltages are present on this circuit board whenever the instrument is attached to an AC power source, whether or not the front panel power switch is "on". The front panel power switch only enables the voltage regulators in the unit, but the unregulated voltages are always present.

Always disconnect the power cord and wait at least two minutes before opening the unit. Check the LED at the front edge of the power supply board. The unit is safe only if the LED is OFF. If the LED is ON, then DO NOT attempt any service on the unit.

UNREGULATED POWER SUPPLIES

A power entry module, with RF line filter, is used to configure the unit for 100, 120, 220, or 240 VAC. The line filter reduces noise from the instrument and reduces the unit's susceptibility to line voltage noise. R1 is an inrush limiter to limit the turn on current and TS1 is a thermal switch which will interrupt the AC line if the heat sink temperature rises to 50°C.

Bridge rectifiers are used to provide unregulated DC at $\pm 22\text{V}$, $\pm 18\text{V}$, $\pm 8\text{V}$, and -4V . Schottky diodes are used for all supplies except the $\pm 22\text{V}$ in order to reduce rectifier losses.

The comparator, U2C, provides a square wave line crossing signal.

Resistors provide a bleed current on all of the unregulated supply filter capacitors. Because of the large capacitances in this circuit, the time for the voltages to bleed to zero is about a minute after the power cord is removed.

Note that the AC power source must be removed in order to discharge the unregulated supplies.

POWER SUPPLY REGULATORS

The voltage regulators provide outputs at $+5\text{V}$, -5.2V , -2V , $\pm 15\text{V}$, and $\pm 12\text{V}$. The low voltage regulators ($\pm 5\text{V}$ and -2V) are designed to operate with a very low drop-out voltage.

U9 is a precision 5.00V reference which is used to

set all of the output voltages. This provides very accurate power supply outputs. The power switch simply switches the power to U9. When U9 is off, the reference voltage is removed and the regulators drop to zero volts.

There are 2 $+5\text{V}$ supplies, one to power the CPU board and disk drive ($+5\text{V}_\text{P}$), and one to power the ECL and TTL data acquisition boards ($+5\text{V}_\text{I}$).

The following description refers to the $+5\text{V}_\text{P}$ supply but describes the $+5\text{V}_\text{I}$, -5.2V , and -2V supplies as well.

The main pass transistor is Q3. The base of this transistor is controlled so that the emitter will provide a low impedance source of 5 VDC. The current gain of Q3 remains large until the collector-emitter voltage drops to about 0.4 VDC, hence the low drop-out voltage of the regulator. The base of Q3 is driven by the emitter of Q6 which is driven by the output of the op amp, U3B. By comparing the output of the regulator to the 5.00V reference, the op amp maintains the regulator's output at 5.00 VDC. The current output from the regulator is measured by the 0.1 Ω resistance of fuse F1. If the current exceeds about 2 Amps, then the output of U3A turns on, pulling the sense input of U3B high, thereby turning off the regulator's output.

U7 and U11 are regulators for $\pm 15\text{VDC}$. U8 senses the output voltages and compares them to the reference to control the adjust pin of the regulators.

U13 and U15 are the $\pm 12\text{V}$ regulators. Since these supplies do not need to be accurate, output sensing is not used, instead, the $\pm 15\text{V}$ outputs are used to set the output levels.

U10 and U12 provide unswitched $\pm 15\text{V}$ sources. These voltages are on whenever the unit is plugged into an AC power source.

U2 provides power-up reset and U1A provides power down reset.

The 24 VDC brushless fan speed is controlled by the temperature in the box. The warmer the box, the faster the fan turns. When cool, the 10 mA drawn by R5 through R4 is not sufficient to turn on Q2. As the box warms above 40°C, R4 becomes a high resistance and some of the 10 mA will go into the base of Q2 turning speeding up the fan. Diode D13 keeps the fan at half speed even when cool. The proportional temperature control can double the fan speed if necessary.

ECL LOGIC BOARD

The ECL Logic Board contains the discriminator, high speed counters, and bin clock generator. 8 bits of count data can be provided every 40 ns to the TTL Logic Board for storage in data acquisition memory.

SIGNAL INPUT

The signal input passes through the signal amplifier. The amplifier has a DC to 250 MHz bandwidth and a gain of 5 over an input range of ± 300 mV. The inputs are protected to ± 5 VDC and ± 50 V transients.

R102, R103, R104, P101, D101, D102, and D103 comprise an overload protection circuit which clamps the amplifier input to ± 350 mV. AC gain is provided by Q101 and Q102 and is compensated by C104. U101 sets the DC gain. Q102 sums the AC and DC signals and can drive its 100 output to ± 2 V. U102, D105, and Q103 provide a temperature compensated bias voltage for the overload protection circuits which is adjusted by P101 to null the DC offset at the input.

DISCRIMINATORS

Comparator U202 discriminates the amplified signal into ECL levels. The threshold is provided by analog voltage SIGLVL and buffered by U201A. The output transistor, Q202, provides a high frequency, low impedance output. The comparator is operated in the Schmitt trigger configuration with about 20 mV of hysteresis. Since the input signal has been amplified by 5, this represents about 4 mV of hysteresis at the input. Control signal SIG_POL sets the polarity of the output at U205A. Q204 and Q205 drive the discriminatory output. There is a delay line between the this output and the front panel BNC connector. This delay compensates for the delay in the counter front end. Thus DISC output pulses overlap the BIN CLK of the bin in which the pulse is counted.

U203 is the trigger discriminator. It operates like the signal discriminator except that it has about 75 mV of hysteresis and no gain in front of it.

U204 is the discriminator for the external bin clock input. The threshold is fixed at 1.3V to trigger TTL pulses. The hysteresis is also about 75 mV.

200 MHZ CLOCK AND TRIGGER SYNC

U301A is a 200 MHz LC tank oscillator. U302 di-

vides the oscillator output by 64 to provide a 3.125 MHz signal to the phase comparator U304. A 25 MHz crystal oscillator, divided by 8 in U306, is the reference signal for U304. The output of the phase comparator is filtered and integrated by U305 to drive the frequency control input of the 200 MHz oscillator, D301. The net result is a 200 MHz, crystal based time base available from U301C.

The discriminated trigger input clocks latch U311A. The latched trigger is input to U309A and U309B. U309A is clocked by the 200 MHz clock and U309B is clocked by the inverted 200 MHz. U310 allows whichever flip-flop clocks first to lock out the other. U308D then outputs a 200 MHz clock which has at most 2.5 ns of indeterminacy with respect to the trigger. The output of U308D is then the master clock for this trigger. U311B divides the clock to 100 MHz and U313B divides to 50 MHz. Q303 and Q304 provide the 50 MHz TEST signal. When all of the bins for the record have been generated, the signal DONE_ECL resets U311A and U311B which disables the clocks. This turns off the BIN CLK output and TEST output.

BIN CLOCK GENERATOR

When the bins clocks are being generated internally, the 100 MHz output of U311B feeds a divider chain made up of U402AB, U403AB, U404A, and U412. U402, U403, and U404 are ECL flip-flops which divide by 2. They are enabled by control lines B0 - B3 to provide divide by 2,4,8,16, or 32. U412 is a TTL divider which can divide by 2 through 2^{15} by programming the A-D inputs. The input to U412 is 6.25 MHz and the last output of U412 can be as low as 1906.7 Hz. The divider outputs are combined in U407B to give an output pulse which is synchronous with the 100 MHz clock and lasts for 10 ns. The output of U407B has a frequency range from 50 MHz to 1906.7 Hz in binary steps.

U404B divides this frequency by 2. U405AB divides the frequency by 2 again and provides 4 outputs which are 90 degrees apart in phase. U406AB synchronizes these outputs with the 100 MHz clock once again. At the highest frequency, the output of U406 will be 12.5 MHz which is the bin clock for 40 ns bins. Each half cycle of the output clock is a 40 ns count bin for a total period of 80 ns or 12.5 MHz. The 4 quadrature signals are combined in U410 to provide signals to reset the counters, latch the count data, write the data to memory, etc. These signals are synchronous with the count bins.

Circuit Description

There are 2 count channels, even and odd. While one counter is counting, the other is storing data and resetting. The complete cycle time is 40 ns of counting and 40 ns of resetting and storing. 2 counters are needed to provide 100% counting duty cycle. U406A provides the 2 count gates, -GATE_ODD and -GATE_EVEN. An even and odd versions of the control signals are also required.

When the bins are clocked externally using the EXT BIN CLK, the first external bin clock after the trigger clocks latch U313A. The output of U313A enables the external bin clock through U407A. Multiplexers U408 and U409 reconfigure the bin clock generator circuit for external clocking. U404B now passes the external clock without dividing by 2. U405AB divides the external clock frequency by 2 and provides a square wave output. U406AB passes this clock to provide the gate and control signals to the counters. Each gate is a half cycle of the output and equals the external clock period. In order to maintain adequate timing margin for the control signals, the minimum high and low time for the external clock is 100 ns. This is because the bin generator does not generate quadrature signals but instead relies on both edges of the external clock for control timing.

With either clock, the first bin gate sets U312A whose output is the SYNC/BUSY output. The bin clock also passes through U205C to drive the BIN CLK OUTPUT.

After the record is acquired and accumulated, the processor needs to rearm the trigger circuits. The BIN_RESET and -BIN_RESET signals clear the bin generators. The ARM_ECL signal rearms the trigger circuit. ARM_ECL also clears the SYNC/BUSY output by clocking U312A.

PULSE SORTER

Signal pulses can arrive at any time, including a bin boundary. To ensure that a pulse is counted, even at a bin boundary, a pulse sorter circuit is used. Signal pulses clock flip-flop U702A. The Q output feeds the D input of U702B. U702B is clocked by the 200 MHz master bin clock. If the Q output of U702B is the same as its D input, then the input pulse has been successfully latched into U702B. When this occurs, the output of U701B goes low which enables U702A to flip at the next signal pulse. U702A will not be allowed to flip states until the first pulse has propagated through U702B, no matter when the pulse arrived. Thus, pulses are latched into U702A until they are captured by U702B. All pulses clocked into U702B will be counted.

U703A is also clocked by the 200 MHz clock. When its output and the output of U702B are different, then a pulse has been detected and the output of U701C goes high. If no other pulses arrive, U701C goes low after the next 200 MHz clock. U701C's output is synchronous with the master bin clock and can be sampled at 5 ns intervals to determine whether a signal pulse arrived during the preceding 5 ns period.

COUNTERS

The even and odd counters are used for 40 ns or greater bin widths. They are identical and only the odd counter is described.

U501A is an ECL flip-flop which counts only when the output of U514A is high when clocked. The clock input is the 200 MHz master bin clock. U514A is high only when the pulse sorter output from U701C is active during the odd gate. Because the pulse sorter output is synchronous with the 200 MHz clock, U501A can sample U514A's output every 5 ns and not miss any pulses. Each time a pulse is detected during the odd gate, U501A will toggle.

U501B, U504AB are also ECL divide by 2 counters. U505 is a FAST TTL counter. Because the counters are reset before each gate, only the first few flip-flops are used during the short bins. For example, in a 40 ns bin, only 8 pulses can be detected so only the first 3 flip-flops will toggle. Thus, the later stages of the counter are used only for longer bins with longer reset times and can be slower counters. The last 8 bits of the counter are U506 and U507 which are synchronous HC counters.

The lower 8 bits of count data are latched into U512 during the even gate. At the same time, the odd counter is reset. Latched data will be written into memory during the next odd gate while the counter is counting the next odd data point. U512 is a FAST latch since the lower 8 bits are used during short bin widths. The upper 8 bits are latched by U511 which is an HC latch since these bits are used only when the bin widths are long.

U508 detects counter overflow and latches the condition in the MSB. Thus, the count range is 32,768 with one overflow detection bit.

SHIFT REGISTER INPUTS

The shift registers are used for the 5 ns bin width. Since each 5 ns bin can only have either one count or no counts, a counter is not needed. Instead, the output of the pulse sorter is fed into a

shift register which stores the state of each 5 ns sample, either a one or a zero.

U703B divides the 200 MHz clock by 2. The 100 MHz and -100 MHz outputs clock 2 8-bit shift registers. The odd register, U705 and U706, is clocked by 100 MHz, and the even register, U707 and U708, is clocked by -100 MHz. Each register stores every other 5 ns data point. Every 80 ns, the LATCH signal goes high. U704AB synchronize the LATCH signal to the 2 100 MHz clocks. The synchronized latch signals clock the data latches U713 and U714. Since each shift register clocks at 10 ns intervals, the latches catch the most recent 8 bits of data in each register. The 2 latches together capture the most recent 16 5 ns bins of data.

CONTROL SIGNALS

The control signals come from the TTL Logic board via the connector JP1602. U1501-U1503 are TTL to ECL level shifters to provide ECL control lines. JP1601 carries the data from the counter data latches to the TTL Logic board.

TTL LOGIC BOARD

The TTL Logic board contains the data acquisition memory and bin counters as well as the accumulation circuitry.

FAST RECORD BUFFERS

The fast record buffers store the points from the counters as the data is acquired in real time. The lower 8 bits of the memory must be able to store in 40 ns. U801 - U804 are 8kbyte, 40 ns static RAMs which can store 32k points of the lower 8 bits of the count data. U805 is a single 32kbyte static RAM which can store 32k points of the upper 8 bits of count data. The upper 8 bits are active only for longer bin widths when the store and reset times are longer. While the record is being acquired, U806 multiplexes the memory write signals to the fast buffer memories.

FAST BUFFER ADDRESS COUNTER

Addresses for the fast buffers are generated by counters U908-U911. Before the trigger is armed, the processor loads the number of bins in a record divided by 2 into the counter. While data is being acquired, the counter is clocked by LATCH_ODD which occurs at half the bin frequency. When the counter counts past zero, the last output bit toggles and the DONE signal is generated. DONE disables the bin generators and interrupts the processor to start accumulating the data in the fast buffers.

The address counter has 16 bits with b3 missing. B15 is reserved to signal done so only 14 bits remain active. However, the clock, LATCH_ODD comes every 2 bins (an even and an odd), the maximum number of bins in a record can be 2^{15} or 32,768. The counter output bits are the address bits for the even fast buffers. U912 and U913 latch the address for the odd fast buffers since the odd buffers write while the buffer is being clocked. All address logic uses FAST parts since a new address can be required every 80 ns.

After the record has been acquired, the data will be read out and accumulated into an accumulation memory. During accumulation, the 16 MHz oscillator, U901, generates the address clocks. Before accumulation, the address counters are reloaded with the bins/record divided by 2. U902 divides the 16 MHz by 4 and U905B divides by 2 so the address is clocked at 2 MHz. Each address represents 2 data points, an even and an odd. The control line START_ACC begins accumulation. Accumulation proceeds at 250 ns per point until

Circuit Description

the DONE signal becomes active. DONE interrupts the processor to rearm the trigger to acquire the next record.

ACCUMULATOR

U1012 and U1013 are 32kbyte accumulation RAMs. U1012 is the lower 8 bits and U1013 is the upper 8 bits. The address to these RAMs comes from the fast buffer address counter. During acquisition, the accumulation RAMs are disabled so the address does not matter.

The accumulation of a data point proceeds as follows. When the new buffer address is clocked, the present value of the accumulation at that address is read from the accumulation RAMs. At the same time, fast buffer data from that address is read from the even and the odd fast buffers. The odd buffer data is enabled by U1001 and the even data by U1003. The high byte of count data comes directly from U805 since it holds both even and odd data.

The odd data is enabled into exclusive or gates U1020-U1023. These gates are used to complement the incoming data for subtraction. The outputs of the XOR gates is fed into 4 4-bit adders, U1006-U1009. The other input to the adders is the accumulation data from U1012 and U1013. The output of the adders is the sum of the accumulation with the new data and is latched into U1010 and U1011. The accumulation RAMs are then put into the write mode, the outputs of U1010 and U1011 are enabled and the new accumulation is written into RAM at the same address.

The process repeats itself for the even data. The lowest address bit of the accumulation RAM is the even/odd selection bit. After the even data is finished, the address is clocked to next address and the odd data is accumulated again. This repeats until DONE is active and all bins have been accumulated.

For the case of 5 ns bin widths, each byte of data in the fast buffer represents 8 bits of data from 8 bins. Latching multiplexers U1002 and U1004 are used to convert the parallel data into serial data. Every 8 addresses, the fast data is latched into U1002 and U1004. The lower 3 bits of accumulation address now select a bit within each byte to output from the multiplexers. The inverse of the selected bit is bit0 of the new data. The other inputs to U1020-U1023 are pulled high. The XOR gates are used to complement the data so that the sign of the output is correct. Accumulation proceeds as above with the new data being 1 or 0 only.

U1017 and U1018 are 32kbyte copy buffers which interface to the processor. While data is accumulating, U1017 and U1018 can copy an image of the accumulation buffer. U1014 and U1015 enable the adder outputs onto U1017 and U1018's data bus. The address to these buffer RAMs comes from a counter similar to the fast buffer address counter. While copying the accumulation data, this address is clocked along with the fast buffer address.

The result is a complete copy of the accumulation memory. U1014 and U1015 can then be disabled and the data from U1016 and U1018 can be read by the processor, even while new records are being accumulated. This allows the processor to display data while it is being acquired without interfering with accumulation and never displaying an incomplete accumulation. When the processor is finished reading the copied data, the processor enables the copy buffers again and a copy is made of the next accumulation.

The accumulation and copy buffers are reset by forcing the adder outputs to zero during an accumulation. The accumulation memory data bus is tri-stated and pulled up to FFFFH. The incoming fast data bus is tri-stated and pulled up to FFFFH also. The fast data is complemented to 0000H by the XOR gates. The carry input to the first adder is set to 1. The result is the addition of FFFFH and 0001H. The adder output is 0000H and is latched into the accumulation and copy buffers.

COPY BUFFER ADDRESS COUNTER

U1103-U1106 are counters which generate the address for the copy buffer memory. When copying an accumulation, the counters are loaded with the same address as the fast buffer address counter. The counter is clocked by copy buffer write signal which is derived from the accumulation buffer write signal. When the copy is complete, the starting address is reloaded, and the processor can read the buffer via U1016 and U1019 with each read pulse clocking the address counter. Since the address automatically increments, the processor can read the data at high speed.

STATUS AND IO

U1301 is the status input port. U1309A detects triggers which arrive while the previous record is still being acquired or accumulated. U906B latches the SUBTRACT input and U1309B latches the INHIBIT input. Any overflow which occurs during accumulation will set U1308A and be latched into U1308B at the end of accumulation.

U1302-U1306 are the output ports. The processor writes to these ports via the expansion connector.

DIGITAL TO ANALOG CONVERTER

U1602 is a 12-bit D/A converter which is loaded 4 bits at a time by the processor. The voltage output from U1603A is 0 to -5.12V. U1603B shifts and scales this output to provide -2 to +2 V. U1604 multiplexes this output to 4 sample and hold amplifiers.

Circuit Description

SR430 COMPONENT PARTS LIST

CONTROL BOARD

<u>REF.</u>	<u>SRS part</u>	<u>VALUE</u>	<u>DESCRIPTION</u>
BT701	6-00001-612	BR-2/3A 2PIN PC	Battery
C 101	5-00177-501	30P	Capacitor, Ceramic Disc, 50V, 10%, SL
C 102	5-00215-501	20P	Capacitor, Ceramic Disc, 50V, 10%, SL
C 103	5-00028-507	100P	Capacitor, Ceramic Disc, 250V, 10%, Y5P
C 501	5-00215-501	20P	Capacitor, Ceramic Disc, 50V, 10%, SL
C 601	5-00033-520	47U	Capacitor, Electrolytic, 16V, 20%, Rad
C 602	5-00012-501	330P	Capacitor, Ceramic Disc, 50V, 10%, SL
C 603	5-00012-501	330P	Capacitor, Ceramic Disc, 50V, 10%, SL
C 701	5-00064-513	.0047U	Capacitor, Mylar/Poly, 50V, 5%, Rad
C 702	5-00215-501	20P	Capacitor, Ceramic Disc, 50V, 10%, SL
C 703	5-00003-501	10P	Capacitor, Ceramic Disc, 50V, 10%, SL
C 704	5-00012-501	330P	Capacitor, Ceramic Disc, 50V, 10%, SL
C 705	5-00012-501	330P	Capacitor, Ceramic Disc, 50V, 10%, SL
C 706	5-00061-513	.001U	Capacitor, Mylar/Poly, 50V, 5%, Rad
C 707	5-00033-520	47U	Capacitor, Electrolytic, 16V, 20%, Rad
C 801	5-00178-501	62P	Capacitor, Ceramic Disc, 50V, 10%, SL
C 802	5-00178-501	62P	Capacitor, Ceramic Disc, 50V, 10%, SL
C 803	5-00100-517	2.2U	Capacitor, Tantalum, 35V, 20%, Rad
C 804	5-00100-517	2.2U	Capacitor, Tantalum, 35V, 20%, Rad
C 805	5-00100-517	2.2U	Capacitor, Tantalum, 35V, 20%, Rad
C 806	5-00100-517	2.2U	Capacitor, Tantalum, 35V, 20%, Rad
C 807	5-00100-517	2.2U	Capacitor, Tantalum, 35V, 20%, Rad
C 808	5-00100-517	2.2U	Capacitor, Tantalum, 35V, 20%, Rad
C 901	5-00003-501	10P	Capacitor, Ceramic Disc, 50V, 10%, SL
C 902	5-00003-501	10P	Capacitor, Ceramic Disc, 50V, 10%, SL
C 903	5-00061-513	.001U	Capacitor, Mylar/Poly, 50V, 5%, Rad
C 904	5-00223-513	.027U	Capacitor, Mylar/Poly, 50V, 5%, Rad
C 905	5-00068-513	.047U	Capacitor, Mylar/Poly, 50V, 5%, Rad
C 906	5-00061-513	.001U	Capacitor, Mylar/Poly, 50V, 5%, Rad
C 907	5-00012-501	330P	Capacitor, Ceramic Disc, 50V, 10%, SL
C 908	5-00012-501	330P	Capacitor, Ceramic Disc, 50V, 10%, SL
C 909	5-00178-501	62P	Capacitor, Ceramic Disc, 50V, 10%, SL
C 910	5-00178-501	62P	Capacitor, Ceramic Disc, 50V, 10%, SL
C 1001	5-00225-548	.1U AXIAL	Capacitor, Ceramic, 50V,+80/-20% Z5U AX
C 1002	5-00225-548	.1U AXIAL	Capacitor, Ceramic, 50V,+80/-20% Z5U AX
C 1003	5-00225-548	.1U AXIAL	Capacitor, Ceramic, 50V,+80/-20% Z5U AX
C 1004	5-00225-548	.1U AXIAL	Capacitor, Ceramic, 50V,+80/-20% Z5U AX
C 1005	5-00100-517	2.2U	Capacitor, Tantalum, 35V, 20%, Rad
C 1006	5-00225-548	.1U AXIAL	Capacitor, Ceramic, 50V,+80/-20% Z5U AX
C 1007	5-00225-548	.1U AXIAL	Capacitor, Ceramic, 50V,+80/-20% Z5U AX
C 1008	5-00225-548	.1U AXIAL	Capacitor, Ceramic, 50V,+80/-20% Z5U AX
C 1009	5-00225-548	.1U AXIAL	Capacitor, Ceramic, 50V,+80/-20% Z5U AX
C 1010	5-00225-548	.1U AXIAL	Capacitor, Ceramic, 50V,+80/-20% Z5U AX
C 1011	5-00225-548	.1U AXIAL	Capacitor, Ceramic, 50V,+80/-20% Z5U AX
C 1012	5-00225-548	.1U AXIAL	Capacitor, Ceramic, 50V,+80/-20% Z5U AX
C 1013	5-00225-548	.1U AXIAL	Capacitor, Ceramic, 50V,+80/-20% Z5U AX
C 1014	5-00100-517	2.2U	Capacitor, Tantalum, 35V, 20%, Rad
C 1015	5-00225-548	.1U AXIAL	Capacitor, Ceramic, 50V,+80/-20% Z5U AX

Part List

C 1016	5-00225-548	.1U AXIAL	Capacitor, Ceramic, 50V,+80/-20% Z5U AX
C 1017	5-00225-548	.1U AXIAL	Capacitor, Ceramic, 50V,+80/-20% Z5U AX
C 1018	5-00225-548	.1U AXIAL	Capacitor, Ceramic, 50V,+80/-20% Z5U AX
C 1019	5-00225-548	.1U AXIAL	Capacitor, Ceramic, 50V,+80/-20% Z5U AX
C 1020	5-00225-548	.1U AXIAL	Capacitor, Ceramic, 50V,+80/-20% Z5U AX
C 1021	5-00225-548	.1U AXIAL	Capacitor, Ceramic, 50V,+80/-20% Z5U AX
C 1022	5-00225-548	.1U AXIAL	Capacitor, Ceramic, 50V,+80/-20% Z5U AX
C 1023	5-00100-517	2.2U	Capacitor, Tantalum, 35V, 20%, Rad
C 1024	5-00225-548	.1U AXIAL	Capacitor, Ceramic, 50V,+80/-20% Z5U AX
C 1025	5-00225-548	.1U AXIAL	Capacitor, Ceramic, 50V,+80/-20% Z5U AX
C 1026	5-00100-517	2.2U	Capacitor, Tantalum, 35V, 20%, Rad
C 1027	5-00225-548	.1U AXIAL	Capacitor, Ceramic, 50V,+80/-20% Z5U AX
C 1028	5-00225-548	.1U AXIAL	Capacitor, Ceramic, 50V,+80/-20% Z5U AX
C 1029	5-00225-548	.1U AXIAL	Capacitor, Ceramic, 50V,+80/-20% Z5U AX
C 1030	5-00225-548	.1U AXIAL	Capacitor, Ceramic, 50V,+80/-20% Z5U AX
C 1031	5-00225-548	.1U AXIAL	Capacitor, Ceramic, 50V,+80/-20% Z5U AX
C 1032	5-00225-548	.1U AXIAL	Capacitor, Ceramic, 50V,+80/-20% Z5U AX
C 1033	5-00225-548	.1U AXIAL	Capacitor, Ceramic, 50V,+80/-20% Z5U AX
C 1034	5-00225-548	.1U AXIAL	Capacitor, Ceramic, 50V,+80/-20% Z5U AX
C 1035	5-00225-548	.1U AXIAL	Capacitor, Ceramic, 50V,+80/-20% Z5U AX
C 1036	5-00225-548	.1U AXIAL	Capacitor, Ceramic, 50V,+80/-20% Z5U AX
C 1037	5-00225-548	.1U AXIAL	Capacitor, Ceramic, 50V,+80/-20% Z5U AX
C 1038	5-00100-517	2.2U	Capacitor, Tantalum, 35V, 20%, Rad
C 1039	5-00225-548	.1U AXIAL	Capacitor, Ceramic, 50V,+80/-20% Z5U AX
C 1040	5-00225-548	.1U AXIAL	Capacitor, Ceramic, 50V,+80/-20% Z5U AX
C 1041	5-00225-548	.1U AXIAL	Capacitor, Ceramic, 50V,+80/-20% Z5U AX
C 1042	5-00100-517	2.2U	Capacitor, Tantalum, 35V, 20%, Rad
C 1043	5-00225-548	.1U AXIAL	Capacitor, Ceramic, 50V,+80/-20% Z5U AX
C 1044	5-00225-548	.1U AXIAL	Capacitor, Ceramic, 50V,+80/-20% Z5U AX
D 401	3-00004-301	1N4148	Diode
D 601	3-00004-301	1N4148	Diode
D 602	3-00004-301	1N4148	Diode
D 603	3-00004-301	1N4148	Diode
D 604	3-00004-301	1N4148	Diode
D 605	3-00004-301	1N4148	Diode
D 606	3-00004-301	1N4148	Diode
D 607	3-00004-301	1N4148	Diode
D 608	3-00004-301	1N4148	Diode
D 701	3-00203-301	1N5711	Diode
D 702	3-00004-301	1N4148	Diode
D 703	3-00004-301	1N4148	Diode
D 704	3-00004-301	1N4148	Diode
D 705	3-00004-301	1N4148	Diode
JP201	1-00109-130	4 PIN DI	Connector, Male
JP301	1-00042-130	8 PIN DI	Connector, Male
JP302	1-00008-130	20 PIN DI	Connector, Male
JP303	1-00109-130	4 PIN DI	Connector, Male
JP601	1-00113-100	DIN 5	Connector, Misc.
JP602	1-00207-133	30 PIN DRA	Connector, Male, Right Angle
JP603	1-00109-130	4 PIN DI	Connector, Male
JP701	1-00006-130	2 PIN DI	Connector, Male
JP702	1-00083-130	26 PIN DIL	Connector, Male
JP801	1-00035-130	20 PIN DIL	Connector, Male
JP802	1-00109-130	4 PIN DI	Connector, Male
JP803	1-00086-130	3 PIN SI	Connector, Male

Part List

JP901	1-00209-133	34 PIN DRA	Connector, Male, Right Angle
JP902	1-00238-161	GPIB SHIELDED	Connector, IEEE488, Reverse, R/A, Female
JP903	1-00016-160	RS232 25 PIN D	Connector, D-Sub, Right Angle PC, Female
JP1000	1-00088-130	40 PIN DI	Connector, Male
JP1001	1-00088-130	40 PIN DI	Connector, Male
JP1002	1-00039-116	5 PIN, WHITE	Header, Amp, MTA-156
N 101	4-00587-425	10KX7	Resistor Network SIP 1/4W 2% (Common)
N 102	4-00334-425	10KX5	Resistor Network SIP 1/4W 2% (Common)
N 501	4-00334-425	10KX5	Resistor Network SIP 1/4W 2% (Common)
N 601	4-00227-425	22KX9	Resistor Network SIP 1/4W 2% (Common)
N 701	4-00270-425	1.0KX5	Resistor Network SIP 1/4W 2% (Common)
N 801	4-00334-425	10KX5	Resistor Network SIP 1/4W 2% (Common)
N 901	4-00221-425	150X5	Resistor Network SIP 1/4W 2% (Common)
N 902	4-00244-421	10KX4	Res. Network, SIP, 1/4W,2% (Isolated)
PC1	7-00240-701	001	Printed Circuit Board
Q 401	3-00026-325	2N5210	Transistor, TO-92 Package
Q 701	3-00022-325	2N3906	Transistor, TO-92 Package
Q 702	3-00021-325	2N3904	Transistor, TO-92 Package
Q 703	3-00021-325	2N3904	Transistor, TO-92 Package
Q 705	3-00022-325	2N3906	Transistor, TO-92 Package
R 401	4-00034-401	10K	Resistor, Carbon Film, 1/4W, 5%
R 402	4-00079-401	4.7K	Resistor, Carbon Film, 1/4W, 5%
R 502	4-00034-401	10K	Resistor, Carbon Film, 1/4W, 5%
R 601	4-00034-401	10K	Resistor, Carbon Film, 1/4W, 5%
R 602	4-00034-401	10K	Resistor, Carbon Film, 1/4W, 5%
R 701	4-00088-401	51K	Resistor, Carbon Film, 1/4W, 5%
R 702	4-00021-401	1.0K	Resistor, Carbon Film, 1/4W, 5%
R 703	4-00034-401	10K	Resistor, Carbon Film, 1/4W, 5%
R 704	4-00034-401	10K	Resistor, Carbon Film, 1/4W, 5%
R 705	4-00034-401	10K	Resistor, Carbon Film, 1/4W, 5%
R 706	4-00034-401	10K	Resistor, Carbon Film, 1/4W, 5%
R 707	4-00063-401	3.0K	Resistor, Carbon Film, 1/4W, 5%
R 708	4-00035-401	10M	Resistor, Carbon Film, 1/4W, 5%
R 709	4-00054-401	200K	Resistor, Carbon Film, 1/4W, 5%
R 710	4-00080-401	47	Resistor, Carbon Film, 1/4W, 5%
R 711	4-00080-401	47	Resistor, Carbon Film, 1/4W, 5%
R 712	4-00021-401	1.0K	Resistor, Carbon Film, 1/4W, 5%
R 713	4-00089-401	56	Resistor, Carbon Film, 1/4W, 5%
R 714	4-00079-401	4.7K	Resistor, Carbon Film, 1/4W, 5%
R 715	4-00031-401	100	Resistor, Carbon Film, 1/4W, 5%
R 801	4-00022-401	1.0M	Resistor, Carbon Film, 1/4W, 5%
R 802	4-00062-401	270	Resistor, Carbon Film, 1/4W, 5%
R 808	4-00060-401	240	Resistor, Carbon Film, 1/4W, 5%
R 809	4-00081-401	470	Resistor, Carbon Film, 1/4W, 5%
R 901	4-00273-401	5.6K	Resistor, Carbon Film, 1/4W, 5%
R 904	4-00090-401	560	Resistor, Carbon Film, 1/4W, 5%
R 905	4-00090-401	560	Resistor, Carbon Film, 1/4W, 5%
R 911	4-00022-401	1.0M	Resistor, Carbon Film, 1/4W, 5%
R 912	4-00062-401	270	Resistor, Carbon Film, 1/4W, 5%
R 913	4-00021-401	1.0K	Resistor, Carbon Film, 1/4W, 5%
SO101	1-00108-150	PLCC 68 TH	Socket, THRU-HOLE
SO301	1-00026-150	28 PIN 600 MIL	Socket, THRU-HOLE
SO302	1-00026-150	28 PIN 600 MIL	Socket, THRU-HOLE
SO303	1-00026-150	28 PIN 600 MIL	Socket, THRU-HOLE
SO304	1-00026-150	28 PIN 600 MIL	Socket, THRU-HOLE

Part List

U 101	3-00354-340	80C186-12	Integrated Circuit (Thru-hole Pkg)
U 201	3-00340-340	74ALS373	Integrated Circuit (Thru-hole Pkg)
U 202	3-00340-340	74ALS373	Integrated Circuit (Thru-hole Pkg)
U 203	3-00340-340	74ALS373	Integrated Circuit (Thru-hole Pkg)
U 204	3-00341-340	74ALS245	Integrated Circuit (Thru-hole Pkg)
U 205	3-00341-340	74ALS245	Integrated Circuit (Thru-hole Pkg)
U 206	3-00342-340	74ALS138	Integrated Circuit (Thru-hole Pkg)
U 207	3-00343-340	74ALS32	Integrated Circuit (Thru-hole Pkg)
U 208	3-00344-340	74ALS08	Integrated Circuit (Thru-hole Pkg)
U 401	3-00299-341	32KX8-100L	STATIC RAM, I.C.
U 402	3-00299-341	32KX8-100L	STATIC RAM, I.C.
U 403	3-00299-341	32KX8-100L	STATIC RAM, I.C.
U 404	3-00299-341	32KX8-100L	STATIC RAM, I.C.
U 501	3-00342-340	74ALS138	Integrated Circuit (Thru-hole Pkg)
U 502	3-00342-340	74ALS138	Integrated Circuit (Thru-hole Pkg)
U 503	3-00342-340	74ALS138	Integrated Circuit (Thru-hole Pkg)
U 504	3-00049-340	74HC74	Integrated Circuit (Thru-hole Pkg)
U 505	3-00347-340	74LS148	Integrated Circuit (Thru-hole Pkg)
U 506	3-00259-340	74HCT373	Integrated Circuit (Thru-hole Pkg)
U 601	3-00049-340	74HC74	Integrated Circuit (Thru-hole Pkg)
U 602	3-00348-340	74HC20	Integrated Circuit (Thru-hole Pkg)
U 603	3-00265-340	74HC595	Integrated Circuit (Thru-hole Pkg)
U 606	3-00044-340	74HC244	Integrated Circuit (Thru-hole Pkg)
U 607	3-00046-340	74HC374	Integrated Circuit (Thru-hole Pkg)
U 608	3-00044-340	74HC244	Integrated Circuit (Thru-hole Pkg)
U 609	3-00046-340	74HC374	Integrated Circuit (Thru-hole Pkg)
U 610	3-00049-340	74HC74	Integrated Circuit (Thru-hole Pkg)
U 611	3-00049-340	74HC74	Integrated Circuit (Thru-hole Pkg)
U 612	3-00039-340	74HC14	Integrated Circuit (Thru-hole Pkg)
U 701	3-00051-340	74HCU04	Integrated Circuit (Thru-hole Pkg)
U 702	3-00349-340	MC146818P	Integrated Circuit (Thru-hole Pkg)
U 703	3-00300-340	74LS374	Integrated Circuit (Thru-hole Pkg)
U 704	3-00263-340	DS75451N	Integrated Circuit (Thru-hole Pkg)
U 705	3-00110-340	MC1489	Integrated Circuit (Thru-hole Pkg)
U 706	3-00251-340	74C04	Integrated Circuit (Thru-hole Pkg)
U 801	3-00051-340	74HCU04	Integrated Circuit (Thru-hole Pkg)
U 802	3-00171-340	74HC191	Integrated Circuit (Thru-hole Pkg)
U 803	3-00277-340	74HC11	Integrated Circuit (Thru-hole Pkg)
U 804	3-00351-340	74HCT299	Integrated Circuit (Thru-hole Pkg)
U 805	3-00280-340	74HC10	Integrated Circuit (Thru-hole Pkg)
U 806	3-00049-340	74HC74	Integrated Circuit (Thru-hole Pkg)
U 807	3-00274-340	74AC74	Integrated Circuit (Thru-hole Pkg)
U 808	3-00303-340	74HC164	Integrated Circuit (Thru-hole Pkg)
U 809	3-00351-340	74HCT299	Integrated Circuit (Thru-hole Pkg)
U 810	3-00598-340	63484P-98	Integrated Circuit (Thru-hole Pkg)
U 811	3-00046-340	74HC374	Integrated Circuit (Thru-hole Pkg)
U 812	3-00046-340	74HC374	Integrated Circuit (Thru-hole Pkg)
U 813	3-00299-341	32KX8-100L	STATIC RAM, I.C.
U 814	3-00299-341	32KX8-100L	STATIC RAM, I.C.
U 815	3-00262-340	74HC86	Integrated Circuit (Thru-hole Pkg)
U 901	3-00350-340	74ALS04	Integrated Circuit (Thru-hole Pkg)
U 902	3-00645-340	NAT9914APD	Integrated Circuit (Thru-hole Pkg)
U 903	3-00078-340	DS75160A	Integrated Circuit (Thru-hole Pkg)
U 904	3-00079-340	DS75161A	Integrated Circuit (Thru-hole Pkg)
U 905	3-00247-340	SCN2641	Integrated Circuit (Thru-hole Pkg)

Part List

U 906	3-00109-340	MC1488	Integrated Circuit (Thru-hole Pkg)
U 907	3-00353-340	DP8473N	Integrated Circuit (Thru-hole Pkg)
U 908	3-00040-340	74HC157	Integrated Circuit (Thru-hole Pkg)
X 101	6-00068-620	24.000 MHZ	Crystal
X 701	6-00015-620	32.768 KHZ	Crystal
X 801	6-00069-620	13.5168 MHZ	Crystal
X 901	6-00068-620	24.000 MHZ	Crystal
X 902	6-00037-620	3.6864 MHZ	Crystal
Z 0	0-00192-015	CLS-440-3	Nut, PEM
Z 0	1-00087-131	2 PIN JUMPER	Connector, Female
Z 0	1-00136-171	26 COND	Cable Assembly, Ribbon
Z 0	1-00137-165	25 PIN IDC	Connector, D-Sub, Female

POWER SUPPLY BOARD

<u>REF.</u>	<u>SRS part</u>	<u>VALUE</u>	<u>DESCRIPTION</u>
C 1	5-00124-526	5600U	Capacitor, Electrolytic, 35V, 20%, Rad
C 2	5-00124-526	5600U	Capacitor, Electrolytic, 35V, 20%, Rad
C 3	5-00229-521	15000U	Capacitor, Electrolytic, 25V, 20%, Rad
C 4	5-00229-521	15000U	Capacitor, Electrolytic, 25V, 20%, Rad
C 5	5-00230-550	47000U	Capacitor, Electrolytic, 10V, 20%, Rad
C 6	5-00230-550	47000U	Capacitor, Electrolytic, 10V, 20%, Rad
C 7	5-00231-537	39000U	Capacitor, 6.3V Electrolytic
C 9	5-00023-529	.1U	Cap, Monolythic Ceramic, 50V, 20%, Z5U
C 10	5-00023-529	.1U	Cap, Monolythic Ceramic, 50V, 20%, Z5U
C 11	5-00002-501	100P	Capacitor, Ceramic Disc, 50V, 10%, SL
C 12	5-00002-501	100P	Capacitor, Ceramic Disc, 50V, 10%, SL
C 13	5-00002-501	100P	Capacitor, Ceramic Disc, 50V, 10%, SL
C 14	5-00002-501	100P	Capacitor, Ceramic Disc, 50V, 10%, SL
C 15	5-00027-503	.01U	Capacitor, Ceramic Disc, 50V, 20%, Z5U
C 16	5-00027-503	.01U	Capacitor, Ceramic Disc, 50V, 20%, Z5U
C 17	5-00027-503	.01U	Capacitor, Ceramic Disc, 50V, 20%, Z5U
C 18	5-00027-503	.01U	Capacitor, Ceramic Disc, 50V, 20%, Z5U
C 19	5-00002-501	100P	Capacitor, Ceramic Disc, 50V, 10%, SL
C 20	5-00038-509	10U	Capacitor, Electrolytic, 50V, 20%, Rad
C 21	5-00098-517	10U	Capacitor, Tantalum, 35V, 20%, Rad
C 22	5-00100-517	2.2U	Capacitor, Tantalum, 35V, 20%, Rad
C 23	5-00100-517	2.2U	Capacitor, Tantalum, 35V, 20%, Rad
C 24	5-00100-517	2.2U	Capacitor, Tantalum, 35V, 20%, Rad
C 25	5-00100-517	2.2U	Capacitor, Tantalum, 35V, 20%, Rad
C 26	5-00002-501	100P	Capacitor, Ceramic Disc, 50V, 10%, SL
C 27	5-00038-509	10U	Capacitor, Electrolytic, 50V, 20%, Rad
C 28	5-00098-517	10U	Capacitor, Tantalum, 35V, 20%, Rad
C 29	5-00038-509	10U	Capacitor, Electrolytic, 50V, 20%, Rad
C 30	5-00098-517	10U	Capacitor, Tantalum, 35V, 20%, Rad
C 31	5-00023-529	.1U	Cap, Monolythic Ceramic, 50V, 20%, Z5U
C 32	5-00098-517	10U	Capacitor, Tantalum, 35V, 20%, Rad
C 33	5-00023-529	.1U	Cap, Monolythic Ceramic, 50V, 20%, Z5U
C 34	5-00098-517	10U	Capacitor, Tantalum, 35V, 20%, Rad
C 35	5-00023-529	.1U	Cap, Monolythic Ceramic, 50V, 20%, Z5U

Part List

C 36	5-00100-517	2.2U	Capacitor, Tantalum, 35V, 20%, Rad
C 37	5-00100-517	2.2U	Capacitor, Tantalum, 35V, 20%, Rad
C 38	5-00098-517	10U	Capacitor, Tantalum, 35V, 20%, Rad
C 39	5-00098-517	10U	Capacitor, Tantalum, 35V, 20%, Rad
C 40	5-00098-517	10U	Capacitor, Tantalum, 35V, 20%, Rad
C 41	5-00098-517	10U	Capacitor, Tantalum, 35V, 20%, Rad
D 2	3-00391-301	MBR360	Diode
D 3	3-00391-301	MBR360	Diode
D 4	3-00391-301	MBR360	Diode
D 5	3-00391-301	MBR360	Diode
D 6	3-00226-301	1N5822	Diode
D 7	3-00226-301	1N5822	Diode
D 8	3-00226-301	1N5822	Diode
D 9	3-00226-301	1N5822	Diode
D 10	3-00226-301	1N5822	Diode
D 11	3-00226-301	1N5822	Diode
D 12	3-00181-340	RS401LR-ND	Integrated Circuit (Thru-hole Pkg)
D 13	3-00001-301	1N4001	Diode
D 14	3-00004-301	1N4148	Diode
D 15	3-00004-301	1N4148	Diode
D 16	3-00004-301	1N4148	Diode
D 17	3-00004-301	1N4148	Diode
D 18	3-00001-301	1N4001	Diode
D 19	3-00001-301	1N4001	Diode
D 20	3-00001-301	1N4001	Diode
D 21	3-00001-301	1N4001	Diode
D 22	3-00001-301	1N4001	Diode
D 23	3-00226-301	1N5822	Diode
DS1	3-00011-303	RED	LED, T1 Package
F 1	4-00436-409	.1	Resistor, Wire Wound
F 2	4-00436-409	.1	Resistor, Wire Wound
F 3	4-00436-409	.1	Resistor, Wire Wound
F 4	4-00436-409	.1	Resistor, Wire Wound
J 1	1-00114-116	10 PIN, WHITE	Header, Amp, MTA-156
JP1	1-00039-116	5 PIN, WHITE	Header, Amp, MTA-156
JP2	1-00116-130	4 PIN DI DISK	Connector, Male
JP3	1-00119-116	3 PIN, WHITE	Header, Amp, MTA-156
JP4	1-00117-116	20 PIN, WHITE	Header, Amp, MTA-156
PC1	7-00262-701	002	Printed Circuit Board
Q 1	3-00022-325	2N3906	Transistor, TO-92 Package
Q 2	3-00233-329	TIP31B	Voltage Reg., TO-220 (TAB) Package
Q 3	3-00257-329	TIP41B	Voltage Reg., TO-220 (TAB) Package
Q 4	3-00258-329	TIP42	Voltage Reg., TO-220 (TAB) Package
Q 5	3-00258-329	TIP42	Voltage Reg., TO-220 (TAB) Package
Q 6	3-00378-329	TIP102	Voltage Reg., TO-220 (TAB) Package
Q 7	3-00378-329	TIP102	Voltage Reg., TO-220 (TAB) Package
Q 8	3-00257-329	TIP41B	Voltage Reg., TO-220 (TAB) Package
Q 9	3-00325-329	TIP107	Voltage Reg., TO-220 (TAB) Package
Q 10	3-00325-329	TIP107	Voltage Reg., TO-220 (TAB) Package
R 1	4-00084-401	5.1K	Resistor, Carbon Film, 1/4W, 5%
R 2	4-00063-401	3.0K	Resistor, Carbon Film, 1/4W, 5%
R 3	4-00045-401	2.0K	Resistor, Carbon Film, 1/4W, 5%
R 4	4-00372-431	50-30-25	Thermistor, PTC (Positive Temp Control)
R 5	4-00081-401	470	Resistor, Carbon Film, 1/4W, 5%
R 6	4-00021-401	1.0K	Resistor, Carbon Film, 1/4W, 5%

Part List

R 7	4-00034-401	10K	Resistor, Carbon Film, 1/4W, 5%
R 8	4-00305-401	4.3K	Resistor, Carbon Film, 1/4W, 5%
R 9	4-00046-401	2.0M	Resistor, Carbon Film, 1/4W, 5%
R 10	4-00065-401	3.3K	Resistor, Carbon Film, 1/4W, 5%
R 11	4-00185-407	4.02K	Resistor, Metal Film, 1/8W, 1%, 50PPM
R 12	4-00470-407	10.5K	Resistor, Metal Film, 1/8W, 1%, 50PPM
R 13	4-00138-407	10.0K	Resistor, Metal Film, 1/8W, 1%, 50PPM
R 14	4-00138-407	10.0K	Resistor, Metal Film, 1/8W, 1%, 50PPM
R 15	4-00021-401	1.0K	Resistor, Carbon Film, 1/4W, 5%
R 16	4-00021-401	1.0K	Resistor, Carbon Film, 1/4W, 5%
R 17	4-00021-401	1.0K	Resistor, Carbon Film, 1/4W, 5%
R 18	4-00021-401	1.0K	Resistor, Carbon Film, 1/4W, 5%
R 19	4-00021-401	1.0K	Resistor, Carbon Film, 1/4W, 5%
R 20	4-00021-401	1.0K	Resistor, Carbon Film, 1/4W, 5%
R 21	4-00021-401	1.0K	Resistor, Carbon Film, 1/4W, 5%
R 22	4-00021-401	1.0K	Resistor, Carbon Film, 1/4W, 5%
R 23	4-00172-407	26.1K	Resistor, Metal Film, 1/8W, 1%, 50PPM
R 24	4-00054-401	200K	Resistor, Carbon Film, 1/4W, 5%
R 25	4-00034-401	10K	Resistor, Carbon Film, 1/4W, 5%
R 26	4-00172-407	26.1K	Resistor, Metal Film, 1/8W, 1%, 50PPM
R 27	4-00054-401	200K	Resistor, Carbon Film, 1/4W, 5%
R 28	4-00034-401	10K	Resistor, Carbon Film, 1/4W, 5%
R 29	4-00164-407	20.0K	Resistor, Metal Film, 1/8W, 1%, 50PPM
R 30	4-00054-401	200K	Resistor, Carbon Film, 1/4W, 5%
R 31	4-00054-401	200K	Resistor, Carbon Film, 1/4W, 5%
R 32	4-00493-407	12.4K	Resistor, Metal Film, 1/8W, 1%, 50PPM
R 33	4-00034-401	10K	Resistor, Carbon Film, 1/4W, 5%
R 34	4-00034-401	10K	Resistor, Carbon Film, 1/4W, 5%
R 35	4-00034-401	10K	Resistor, Carbon Film, 1/4W, 5%
R 36	4-00034-401	10K	Resistor, Carbon Film, 1/4W, 5%
R 38	4-00081-401	470	Resistor, Carbon Film, 1/4W, 5%
R 39	4-00149-407	121	Resistor, Metal Film, 1/8W, 1%, 50PPM
R 40	4-00179-407	30.1K	Resistor, Metal Film, 1/8W, 1%, 50PPM
R 41	4-00138-407	10.0K	Resistor, Metal Film, 1/8W, 1%, 50PPM
R 42	4-00188-407	4.99K	Resistor, Metal Film, 1/8W, 1%, 50PPM
R 44	4-00021-401	1.0K	Resistor, Carbon Film, 1/4W, 5%
R 45	4-00169-407	249	Resistor, Metal Film, 1/8W, 1%, 50PPM
R 46	4-00138-407	10.0K	Resistor, Metal Film, 1/8W, 1%, 50PPM
R 47	4-00048-401	2.2K	Resistor, Carbon Film, 1/4W, 5%
R 48	4-00211-407	9.53K	Resistor, Metal Film, 1/8W, 1%, 50PPM
R 49	4-00199-407	6.81K	Resistor, Metal Film, 1/8W, 1%, 50PPM
R 50	4-00130-407	1.00K	Resistor, Metal Film, 1/8W, 1%, 50PPM
R 51	4-00211-407	9.53K	Resistor, Metal Film, 1/8W, 1%, 50PPM
R 52	4-00199-407	6.81K	Resistor, Metal Film, 1/8W, 1%, 50PPM
R 53	4-00130-407	1.00K	Resistor, Metal Film, 1/8W, 1%, 50PPM
R 54	4-00211-407	9.53K	Resistor, Metal Film, 1/8W, 1%, 50PPM
R 55	4-00199-407	6.81K	Resistor, Metal Film, 1/8W, 1%, 50PPM
R 56	4-00130-407	1.00K	Resistor, Metal Film, 1/8W, 1%, 50PPM
R 57	4-00618-402	2.2K	Resistor, Carbon Comp, 1/2W, 5%
R 58	4-00618-402	2.2K	Resistor, Carbon Comp, 1/2W, 5%
R 59	4-00618-402	2.2K	Resistor, Carbon Comp, 1/2W, 5%
R 60	4-00618-402	2.2K	Resistor, Carbon Comp, 1/2W, 5%
R 61	4-00618-402	2.2K	Resistor, Carbon Comp, 1/2W, 5%
R 62	4-00360-401	430	Resistor, Carbon Film, 1/4W, 5%
R 63	4-00360-401	430	Resistor, Carbon Film, 1/4W, 5%

Part List

R 64	4-00051-401	2.7K	Resistor, Carbon Film, 1/4W, 5%
R 65	4-00027-401	1.5K	Resistor, Carbon Film, 1/4W, 5%
R 66	4-00076-401	390	Resistor, Carbon Film, 1/4W, 5%
R 67	4-00051-401	2.7K	Resistor, Carbon Film, 1/4W, 5%
R 68	4-00027-401	1.5K	Resistor, Carbon Film, 1/4W, 5%
U 1	3-00143-340	LM393	Integrated Circuit (Thru-hole Pkg)
U 2	3-00039-340	74HC14	Integrated Circuit (Thru-hole Pkg)
U 3	3-00088-340	LF353	Integrated Circuit (Thru-hole Pkg)
U 4	3-00088-340	LF353	Integrated Circuit (Thru-hole Pkg)
U 5	3-00088-340	LF353	Integrated Circuit (Thru-hole Pkg)
U 6	3-00088-340	LF353	Integrated Circuit (Thru-hole Pkg)
U 7	3-00149-329	LM317T	Voltage Reg., TO-220 (TAB) Package
U 8	3-00088-340	LF353	Integrated Circuit (Thru-hole Pkg)
U 9	3-00319-340	AD586JN	Integrated Circuit (Thru-hole Pkg)
U 10	3-00114-329	7815	Voltage Reg., TO-220 (TAB) Package
U 11	3-00141-329	LM337T	Voltage Reg., TO-220 (TAB) Package
U 12	3-00120-329	7915	Voltage Reg., TO-220 (TAB) Package
U 13	3-00149-329	LM317T	Voltage Reg., TO-220 (TAB) Package
U 14	3-00149-329	LM317T	Voltage Reg., TO-220 (TAB) Package
U 15	3-00141-329	LM337T	Voltage Reg., TO-220 (TAB) Package
U 16	3-00105-340	LM741	Integrated Circuit (Thru-hole Pkg)
Z 0	0-00158-000	60MM 24V	Hardware, Misc.
Z 0	0-00186-021	6-32X1-3/8PP	Screw, Panhead Phillips
Z 0	0-00187-021	4-40X1/4PP	Screw, Panhead Phillips
Z 0	0-00231-043	#4 SHOULDER	Washer, nylon
Z 0	0-00246-043	#8 X 1/16	Washer, nylon
Z 0	0-00309-021	8-32X1/4PP	Screw, Panhead Phillips
Z 0	0-00316-003	PLTFM-28	Insulators
Z 0	7-00285-721	PLTFM-21	Machined Part
Z 1	0-00158-000	60MM 24V	Hardware, Misc.

ECL LOGIC BOARD

<u>REF.</u>	<u>SRS part</u>	<u>VALUE</u>	<u>DESCRIPTION</u>
C316	5-00215-501	20P	Capacitor, Ceramic Disc, 50V, 10%, SL
C 1	5-00100-517	2.2U	Capacitor, Tantalum, 35V, 20%, Rad
C 2	5-00225-548	.1U AXIAL	Capacitor, Ceramic, 50V,+80/-20% Z5U AX
C 3	5-00225-548	.1U AXIAL	Capacitor, Ceramic, 50V,+80/-20% Z5U AX
C 4	5-00225-548	.1U AXIAL	Capacitor, Ceramic, 50V,+80/-20% Z5U AX
C 5	5-00225-548	.1U AXIAL	Capacitor, Ceramic, 50V,+80/-20% Z5U AX
C 6	5-00225-548	.1U AXIAL	Capacitor, Ceramic, 50V,+80/-20% Z5U AX
C 7	5-00225-548	.1U AXIAL	Capacitor, Ceramic, 50V,+80/-20% Z5U AX
C 8	5-00100-517	2.2U	Capacitor, Tantalum, 35V, 20%, Rad
C 9	5-00225-548	.1U AXIAL	Capacitor, Ceramic, 50V,+80/-20% Z5U AX
C 10	5-00100-517	2.2U	Capacitor, Tantalum, 35V, 20%, Rad
C 11	5-00100-517	2.2U	Capacitor, Tantalum, 35V, 20%, Rad
C 12	5-00100-517	2.2U	Capacitor, Tantalum, 35V, 20%, Rad
C 13	5-00225-548	.1U AXIAL	Capacitor, Ceramic, 50V,+80/-20% Z5U AX
C 14	5-00225-548	.1U AXIAL	Capacitor, Ceramic, 50V,+80/-20% Z5U AX
C 15	5-00225-548	.1U AXIAL	Capacitor, Ceramic, 50V,+80/-20% Z5U AX
C 16	5-00225-548	.1U AXIAL	Capacitor, Ceramic, 50V,+80/-20% Z5U AX
C 17	5-00225-548	.1U AXIA	Capacitor, Ceramic, 50V,+80/-20% Z5U AX
C 18	5-00225-548	.1U AXIAL	Capacitor, Ceramic, 50V,+80/-20% Z5U AX

Part List

C 19	5-00225-548	.1U AXIAL	Capacitor, Ceramic, 50V,+80/-20% Z5U AX
C 20	5-00225-548	.1U AXIAL	Capacitor, Ceramic, 50V,+80/-20% Z5U AX
C 21	5-00100-517	2.2U	Capacitor, Tantalum, 35V, 20%, Rad
C 22	5-00225-548	.1U AXIAL	Capacitor, Ceramic, 50V,+80/-20% Z5U AX
C 23	5-00225-548	.1U AXIAL	Capacitor, Ceramic, 50V,+80/-20% Z5U AX
C 24	5-00100-517	2.2U	Capacitor, Tantalum, 35V, 20%, Rad
C 25	5-00225-548	.1U AXIAL	Capacitor, Ceramic, 50V,+80/-20% Z5U AX
C 26	5-00225-548	.1U AXIAL	Capacitor, Ceramic, 50V,+80/-20% Z5U AX
C 27	5-00225-548	.1U AXIAL	Capacitor, Ceramic, 50V,+80/-20% Z5U AX
C 28	5-00225-548	.1U AXIAL	Capacitor, Ceramic, 50V,+80/-20% Z5U AX
C 29	5-00225-548	.1U AXIAL	Capacitor, Ceramic, 50V,+80/-20% Z5U AX
C 30	5-00225-548	.1U AXIAL	Capacitor, Ceramic, 50V,+80/-20% Z5U AX
C 31	5-00225-548	.1U AXIAL	Capacitor, Ceramic, 50V,+80/-20% Z5U AX
C 32	5-00225-548	.1U AXIAL	Capacitor, Ceramic, 50V,+80/-20% Z5U AX
C 33	5-00225-548	.1U AXIAL	Capacitor, Ceramic, 50V,+80/-20% Z5U AX
C 34	5-00225-548	.1U AXIAL	Capacitor, Ceramic, 50V,+80/-20% Z5U AX
C 35	5-00225-548	.1U AXIAL	Capacitor, Ceramic, 50V,+80/-20% Z5U AX
C 36	5-00225-548	.1U AXIAL	Capacitor, Ceramic, 50V,+80/-20% Z5U AX
C 37	5-00225-548	.1U AXIAL	Capacitor, Ceramic, 50V,+80/-20% Z5U AX
C 38	5-00225-548	.1U AXIAL	Capacitor, Ceramic, 50V,+80/-20% Z5U AX
C 39	5-00225-548	.1U AXIAL	Capacitor, Ceramic, 50V,+80/-20% Z5U AX
C 42	5-00225-548	.1U AXIAL	Capacitor, Ceramic, 50V,+80/-20% Z5U AX
C 43	5-00225-548	.1U AXIAL	Capacitor, Ceramic, 50V,+80/-20% Z5U AX
C 101	5-00225-548	.1U AXIAL	Capacitor, Ceramic, 50V,+80/-20% Z5U AX
C 102	5-00038-509	10U	Capacitor, Electrolytic, 50V, 20%, Rad
C 103	5-00225-548	.1U AXIAL	Capacitor, Ceramic, 50V,+80/-20% Z5U AX
C 104	5-00159-501	6.8P	Capacitor, Ceramic Disc, 50V, 10%, SL
C 105	5-00033-520	47U	Capacitor, Electrolytic, 16V, 20%, Rad
C 106	5-00225-548	.1U AXIAL	Capacitor, Ceramic, 50V,+80/-20% Z5U AX
C 107	5-00225-548	.1U AXIAL	Capacitor, Ceramic, 50V,+80/-20% Z5U AX
C 108	5-00033-520	47U	Capacitor, Electrolytic, 16V, 20%, Rad
C 109	5-00225-548	.1U AXIAL	Capacitor, Ceramic, 50V,+80/-20% Z5U AX
C 110	5-00033-520	47U	Capacitor, Electrolytic, 16V, 20%, Rad
C 111	5-00225-548	.1U AXIAL	Capacitor, Ceramic, 50V,+80/-20% Z5U AX
C 112	5-00033-520	47U	Capacitor, Electrolytic, 16V, 20%, Rad
C 201	5-00225-548	.1U AXIAL	Capacitor, Ceramic, 50V,+80/-20% Z5U AX
C 202	5-00002-501	100P	Capacitor, Ceramic Disc, 50V, 10%, SL
C 203	5-00225-548	.1U AXIAL	Capacitor, Ceramic, 50V,+80/-20% Z5U AX
C 204	5-00002-501	100P	Capacitor, Ceramic Disc, 50V, 10%, SL
C 205	5-00002-501	100P	Capacitor, Ceramic Disc, 50V, 10%, SL
C 206	5-00225-548	.1U AXIAL	Capacitor, Ceramic, 50V,+80/-20% Z5U AX
C 207	5-00002-501	100P	Capacitor, Ceramic Disc, 50V, 10%, SL
C 208	5-00225-548	.1U AXIAL	Capacitor, Ceramic, 50V,+80/-20% Z5U AX
C 209	5-00225-548	.1U AXIAL	Capacitor, Ceramic, 50V,+80/-20% Z5U AX
C 210	5-00225-548	.1U AXIAL	Capacitor, Ceramic, 50V,+80/-20% Z5U AX
C 211	5-00100-517	2.2U	Capacitor, Tantalum, 35V, 20%, Rad
C 212	5-00100-517	2.2U	Capacitor, Tantalum, 35V, 20%, Rad
C 213	5-00100-517	2.2U	Capacitor, Tantalum, 35V, 20%, Rad
C 214	5-00100-517	2.2U	Capacitor, Tantalum, 35V, 20%, Rad
C 215	5-00100-517	2.2U	Capacitor, Tantalum, 35V, 20%, Rad
C 216	5-00100-517	2.2U	Capacitor, Tantalum, 35V, 20%, Rad
C 217	5-00225-548	.1U AXIAL	Capacitor, Ceramic, 50V,+80/-20% Z5U AX
C 218	5-00225-548	.1U AXIAL	Capacitor, Ceramic, 50V,+80/-20% Z5U AX
C 219	5-00225-548	.1U AXIAL	Capacitor, Ceramic, 50V,+80/-20% Z5U AX
C 220	5-00225-548	.1U AXIAL	Capacitor, Ceramic, 50V,+80/-20% Z5U AX

Part List

C 221	5-00012-501	330P	Capacitor, Ceramic Disc, 50V, 10%, SL
C 301	5-00225-548	.1U AXIAL	Capacitor, Ceramic, 50V,+80/-20% Z5U AX
C 302	5-00237-523	2P	Capacitor, Silver Mica, Miniature
C 303	5-00238-523	4P	Capacitor, Silver Mica, Miniature
C 304	5-00151-501	680P	Capacitor, Ceramic Disc, 50V, 10%, SL
C 305	5-00151-501	680P	Capacitor, Ceramic Disc, 50V, 10%, SL
C 306	5-00065-513	.01U	Capacitor, Mylar/Poly, 50V, 5%, Rad
C 307	5-00060-512	1.0U	Cap, Stacked Metal Film 50V 5% -40/+85c
C 308	5-00225-548	.1U AXIAL	Capacitor, Ceramic, 50V,+80/-20% Z5U AX
C 309	5-00225-548	.1U AXIAL	Capacitor, Ceramic, 50V,+80/-20% Z5U AX
C 310	5-00225-548	.1U AXIAL	Capacitor, Ceramic, 50V,+80/-20% Z5U AX
C 311	5-00002-501	100P	Capacitor, Ceramic Disc, 50V, 10%, SL
C 312	5-00225-548	.1U AXIAL	Capacitor, Ceramic, 50V,+80/-20% Z5U AX
C 313	5-00225-548	.1U AXIAL	Capacitor, Ceramic, 50V,+80/-20% Z5U AX
C 314	5-00100-517	2.2U	Capacitor, Tantalum, 35V, 20%, Rad
C 315	5-00215-501	20P	Capacitor, Ceramic Disc, 50V, 10%, SL
C 401	5-00225-548	.1U AXIAL	Capacitor, Ceramic, 50V,+80/-20% Z5U AX
C 402	5-00065-513	.01U	Capacitor, Mylar/Poly, 50V, 5%, Rad
C 501	5-00065-513	.01U	Capacitor, Mylar/Poly, 50V, 5%, Rad
C 502	5-00003-501	10P	Capacitor, Ceramic Disc, 50V, 10%, SL
C 601	5-00065-513	.01U	Capacitor, Mylar/Poly, 50V, 5%, Rad
C 602	5-00003-501	10P	Capacitor, Ceramic Disc, 50V, 10%, SL
C 701	5-00225-548	.1U AXIAL	Capacitor, Ceramic, 50V,+80/-20% Z5U AX
C 702	5-00225-548	.1U AXIAL	Capacitor, Ceramic, 50V,+80/-20% Z5U AX
C 703	5-00225-548	.1U AXIAL	Capacitor, Ceramic, 50V,+80/-20% Z5U AX
C 704	5-00225-548	.1U AXIAL	Capacitor, Ceramic, 50V,+80/-20% Z5U AX
C 1501	5-00012-501	330P	Capacitor, Ceramic Disc, 50V, 10%, SL
CX403	5-00003-501	10P	Capacitor, Ceramic Disc, 50V, 10%, SL
D 101	3-00202-301	MSD6100	Diode
D 102	3-00203-301	1N5711	Diode
D 103	3-00203-301	1N5711	Diode
D 104	3-00230-301	1N5240A	Diode
D 105	3-00202-301	MSD6100	Diode
D 201	3-00004-301	1N4148	Diode
D 202	3-00004-301	1N4148	Diode
D 203	3-00004-301	1N4148	Diode
D 204	3-00004-301	1N4148	Diode
D 301	3-00135-301	1N5445A	Diode
D 701	3-00004-301	1N4148	Diode
JP1601	1-00008-130	20 PIN DI	Connector, Male
JP1602	1-00088-130	40 PIN DI	Connector, Male
JP1603	1-00114-116	10 PIN, WHITE	Header, Amp, MTA-156
L 201	6-00017-630	FB43-301	Ferrite Beads
L 301	6-00072-601	.05UH-V	Inductor
L 302	6-00017-630	FB43-301	Ferrite Beads
L 303	6-00017-630	FB43-301	Ferrite Beads
N 201	4-00284-421	1.0KX4	Res. Network, SIP, 1/4W,2% (Isolated)
N 202	4-00247-425	100X9	Resistor Network SIP 1/4W 2% (Common)
N 203	4-00283-421	47X4	Res. Network, SIP, 1/4W,2% (Isolated)
N 301	4-00247-425	100X9	Resistor Network SIP 1/4W 2% (Common)
N 302	4-00247-425	100X9	Resistor Network SIP 1/4W 2% (Common)
N 303	4-00247-425	100X9	Resistor Network SIP 1/4W 2% (Common)
N 304	4-00283-421	47X4	Res. Network, SIP, 1/4W,2% (Isolated)
N 305	4-00247-425	100X9	Resistor Network SIP 1/4W 2% (Common)
N 401	4-00247-425	100X9	Resistor Network SIP 1/4W 2% (Common)

Part List

N 402	4-00247-425	100X9	Resistor Network SIP 1/4W 2% (Common)
N 403	4-00247-425	100X9	Resistor Network SIP 1/4W 2% (Common)
N 404	4-00247-425	100X9	Resistor Network SIP 1/4W 2% (Common)
N 405	4-00422-421	82X5	Res. Network, SIP, 1/4W,2% (Isolated)
N 501	4-00247-425	100X9	Resistor Network SIP 1/4W 2% (Common)
N 601	4-00247-425	100X9	Resistor Network SIP 1/4W 2% (Common)
N 701	4-00247-425	100X9	Resistor Network SIP 1/4W 2% (Common)
N 702	4-00247-425	100X9	Resistor Network SIP 1/4W 2% (Common)
N 703	4-00247-425	100X9	Resistor Network SIP 1/4W 2% (Common)
N 704	4-00247-425	100X9	Resistor Network SIP 1/4W 2% (Common)
N 705	4-00247-425	100X9	Resistor Network SIP 1/4W 2% (Common)
N 1501	4-00247-425	100X9	Resistor Network SIP 1/4W 2% (Common)
P 101	4-00326-441	200	Pot, Multi-Turn Trim, 3/8" Square
PC1	7-00267-701	SR430-ECL	Printed Circuit Board
Q 101	3-00018-324	MRF904	Transistor, TO-72 Package
Q 102	3-00178-327	MRF965	Transistor, TO-46 Package
Q 103	3-00022-325	2N3906	Transistor, TO-92 Package
Q 201	3-00027-325	2N5770	Transistor, TO-92 Package
Q 202	3-00027-325	2N5770	Transistor, TO-92 Package
Q 203	3-00027-325	2N5770	Transistor, TO-92 Package
Q 204	3-00027-325	2N5770	Transistor, TO-92 Package
Q 205	3-00027-325	2N5770	Transistor, TO-92 Package
Q 301	3-00027-325	2N5770	Transistor, TO-92 Package
Q 302	3-00027-325	2N5770	Transistor, TO-92 Package
Q 303	3-00027-325	2N5770	Transistor, TO-92 Package
Q 304	3-00027-325	2N5770	Transistor, TO-92 Package
R 101	4-00374-407	51.1	Resistor, Metal Film, 1/8W, 1%, 50PPM
R 102	4-00347-407	7.50K	Resistor, Metal Film, 1/8W, 1%, 50PPM
R 103	4-00347-407	7.50K	Resistor, Metal Film, 1/8W, 1%, 50PPM
R 104	4-00348-407	2.21K	Resistor, Metal Film, 1/8W, 1%, 50PPM
R 105	4-00088-401	51K	Resistor, Carbon Film, 1/4W, 5%
R 106	4-00079-401	4.7K	Resistor, Carbon Film, 1/4W, 5%
R 107	4-00322-407	316	Resistor, Metal Film, 1/8W, 1%, 50PPM
R 108	4-00327-407	47.5	Resistor, Metal Film, 1/8W, 1%, 50PPM
R 109	4-00021-401	1.0K	Resistor, Carbon Film, 1/4W, 5%
R 110	4-00322-407	316	Resistor, Metal Film, 1/8W, 1%, 50PPM
R 111	4-00358-402	510	Resistor, Carbon Comp, 1/2W, 5%
R 112	4-00030-401	10	Resistor, Carbon Film, 1/4W, 5%
R 113	4-00021-401	1.0K	Resistor, Carbon Film, 1/4W, 5%
R 114	4-00021-401	1.0K	Resistor, Carbon Film, 1/4W, 5%
R 115	4-00188-407	4.99K	Resistor, Metal Film, 1/8W, 1%, 50PPM
R 116	4-00134-407	1.24K	Resistor, Metal Film, 1/8W, 1%, 50PPM
R 117	4-00350-407	3.74K	Resistor, Metal Film, 1/8W, 1%, 50PPM
R 118	4-00351-407	2.32K	Resistor, Metal Film, 1/8W, 1%, 50PPM
R 119	4-00050-401	2.4K	Resistor, Carbon Film, 1/4W, 5%
R 120	4-00021-401	1.0K	Resistor, Carbon Film, 1/4W, 5%
R 121	4-00030-401	10	Resistor, Carbon Film, 1/4W, 5%
R 122	4-00030-401	10	Resistor, Carbon Film, 1/4W, 5%
R 206	4-00034-401	10K	Resistor, Carbon Film, 1/4W, 5%
R 207	4-00063-401	3.0K	Resistor, Carbon Film, 1/4W, 5%
R 208	4-00080-401	47	Resistor, Carbon Film, 1/4W, 5%
R 209	4-00080-401	47	Resistor, Carbon Film, 1/4W, 5%
R 210	4-00030-401	10	Resistor, Carbon Film, 1/4W, 5%
R 211	4-00030-401	10	Resistor, Carbon Film, 1/4W, 5%
R 212	4-00027-401	1.5K	Resistor, Carbon Film, 1/4W, 5%

Part List

R 213	4-00031-401	100	Resistor, Carbon Film, 1/4W, 5%
R 214	4-00034-401	10K	Resistor, Carbon Film, 1/4W, 5%
R 215	4-00034-401	10K	Resistor, Carbon Film, 1/4W, 5%
R 216	4-00063-401	3.0K	Resistor, Carbon Film, 1/4W, 5%
R 217	4-00021-401	1.0K	Resistor, Carbon Film, 1/4W, 5%
R 218	4-00080-401	47	Resistor, Carbon Film, 1/4W, 5%
R 219	4-00080-401	47	Resistor, Carbon Film, 1/4W, 5%
R 220	4-00030-401	10	Resistor, Carbon Film, 1/4W, 5%
R 221	4-00030-401	10	Resistor, Carbon Film, 1/4W, 5%
R 222	4-00081-401	470	Resistor, Carbon Film, 1/4W, 5%
R 223	4-00031-401	100	Resistor, Carbon Film, 1/4W, 5%
R 224	4-00034-401	10K	Resistor, Carbon Film, 1/4W, 5%
R 225	4-00021-401	1.0K	Resistor, Carbon Film, 1/4W, 5%
R 226	4-00080-401	47	Resistor, Carbon Film, 1/4W, 5%
R 227	4-00150-407	13.0K	Resistor, Metal Film, 1/8W, 1%, 50PPM
R 228	4-00158-407	2.00K	Resistor, Metal Film, 1/8W, 1%, 50PPM
R 229	4-00063-401	3.0K	Resistor, Carbon Film, 1/4W, 5%
R 230	4-00080-401	47	Resistor, Carbon Film, 1/4W, 5%
R 231	4-00030-401	10	Resistor, Carbon Film, 1/4W, 5%
R 232	4-00030-401	10	Resistor, Carbon Film, 1/4W, 5%
R 233	4-00081-401	470	Resistor, Carbon Film, 1/4W, 5%
R 234	4-00031-401	100	Resistor, Carbon Film, 1/4W, 5%
R 235	4-00062-401	270	Resistor, Carbon Film, 1/4W, 5%
R 236	4-00031-401	100	Resistor, Carbon Film, 1/4W, 5%
R 237	4-00031-401	100	Resistor, Carbon Film, 1/4W, 5%
R 238	4-00031-401	100	Resistor, Carbon Film, 1/4W, 5%
R 239	4-00031-401	100	Resistor, Carbon Film, 1/4W, 5%
R 240	4-00021-401	1.0K	Resistor, Carbon Film, 1/4W, 5%
R 241	4-00103-401	820	Resistor, Carbon Film, 1/4W, 5%
R 242	4-00021-401	1.0K	Resistor, Carbon Film, 1/4W, 5%
R 243	4-00103-401	820	Resistor, Carbon Film, 1/4W, 5%
R 301	4-00076-401	390	Resistor, Carbon Film, 1/4W, 5%
R 302	4-00076-401	390	Resistor, Carbon Film, 1/4W, 5%
R 303	4-00065-401	3.3K	Resistor, Carbon Film, 1/4W, 5%
R 304	4-00027-401	1.5K	Resistor, Carbon Film, 1/4W, 5%
R 305	4-00027-401	1.5K	Resistor, Carbon Film, 1/4W, 5%
R 306	4-00065-401	3.3K	Resistor, Carbon Film, 1/4W, 5%
R 307	4-00590-401	12K	Resistor, Carbon Film, 1/4W, 5%
R 308	4-00050-401	2.4K	Resistor, Carbon Film, 1/4W, 5%
R 309	4-00098-401	680	Resistor, Carbon Film, 1/4W, 5%
R 310	4-00062-401	270	Resistor, Carbon Film, 1/4W, 5%
R 311	4-00065-401	3.3K	Resistor, Carbon Film, 1/4W, 5%
R 312	4-00086-401	51	Resistor, Carbon Film, 1/4W, 5%
R 314	4-00086-401	51	Resistor, Carbon Film, 1/4W, 5%
R 315	4-00032-401	100K	Resistor, Carbon Film, 1/4W, 5%
R 316	4-00062-401	270	Resistor, Carbon Film, 1/4W, 5%
R 317	4-00080-401	47	Resistor, Carbon Film, 1/4W, 5%
R 318	4-00031-401	100	Resistor, Carbon Film, 1/4W, 5%
R 319	4-00080-401	47	Resistor, Carbon Film, 1/4W, 5%
R 320	4-00031-401	100	Resistor, Carbon Film, 1/4W, 5%
R 321	4-00099-401	680K	Resistor, Carbon Film, 1/4W, 5%
R 322	4-00031-401	100	Resistor, Carbon Film, 1/4W, 5%
R 323	4-00086-401	51	Resistor, Carbon Film, 1/4W, 5%
R 324	4-00022-401	1.0M	Resistor, Carbon Film, 1/4W, 5%
R 404	4-00065-401	3.3K	Resistor, Carbon Film, 1/4W, 5%

Part List

R 405	4-00027-401	1.5K	Resistor, Carbon Film, 1/4W, 5%
R 406	4-00021-401	1.0K	Resistor, Carbon Film, 1/4W, 5%
R 407	4-00103-401	820	Resistor, Carbon Film, 1/4W, 5%
R 408	4-00031-401	100	Resistor, Carbon Film, 1/4W, 5%
R 409	4-00086-401	51	Resistor, Carbon Film, 1/4W, 5%
R 501	4-00471-401	82	Resistor, Carbon Film, 1/4W, 5%
R 502	4-00041-401	150	Resistor, Carbon Film, 1/4W, 5%
R 601	4-00471-401	82	Resistor, Carbon Film, 1/4W, 5%
R 602	4-00041-401	150	Resistor, Carbon Film, 1/4W, 5%
U 101	3-00106-340	LT1007	Integrated Circuit (Thru-hole Pkg)
U 102	3-00106-340	LT1007	Integrated Circuit (Thru-hole Pkg)
U 201	3-00091-340	LF412	Integrated Circuit (Thru-hole Pkg)
U 202	3-00294-340	AD96685	Integrated Circuit (Thru-hole Pkg)
U 203	3-00294-340	AD96685	Integrated Circuit (Thru-hole Pkg)
U 204	3-00294-340	AD96685	Integrated Circuit (Thru-hole Pkg)
U 205	3-00180-340	MC10H107	Integrated Circuit (Thru-hole Pkg)
U 301	3-00266-340	MC10H116	Integrated Circuit (Thru-hole Pkg)
U 302	3-00554-340	SP4633	Integrated Circuit (Thru-hole Pkg)
U 303	3-00359-340	MC10H125	Integrated Circuit (Thru-hole Pkg)
U 304	3-00160-340	74HC4046	Integrated Circuit (Thru-hole Pkg)
U 305	3-00090-340	LF411	Integrated Circuit (Thru-hole Pkg)
U 306	3-00171-340	74HC191	Integrated Circuit (Thru-hole Pkg)
U 307	6-00071-621	25.000 MHZ	Crystal Oscillator
U 308	3-00206-340	MC10H102	Integrated Circuit (Thru-hole Pkg)
U 309	3-00194-340	MC10H131	Integrated Circuit (Thru-hole Pkg)
U 310	3-00194-340	MC10H131	Integrated Circuit (Thru-hole Pkg)
U 311	3-00194-340	MC10H131	Integrated Circuit (Thru-hole Pkg)
U 312	3-00194-340	MC10H131	Integrated Circuit (Thru-hole Pkg)
U 313	3-00194-340	MC10H131	Integrated Circuit (Thru-hole Pkg)
U 314	3-00359-340	MC10H125	Integrated Circuit (Thru-hole Pkg)
U 401	3-00206-340	MC10H102	Integrated Circuit (Thru-hole Pkg)
U 402	3-00194-340	MC10H131	Integrated Circuit (Thru-hole Pkg)
U 403	3-00194-340	MC10H131	Integrated Circuit (Thru-hole Pkg)
U 404	3-00194-340	MC10H131	Integrated Circuit (Thru-hole Pkg)
U 405	3-00194-340	MC10H131	Integrated Circuit (Thru-hole Pkg)
U 406	3-00194-340	MC10H131	Integrated Circuit (Thru-hole Pkg)
U 407	3-00208-340	MC10H109	Integrated Circuit (Thru-hole Pkg)
U 408	3-00269-340	MC10H158	Integrated Circuit (Thru-hole Pkg)
U 409	3-00269-340	MC10H158	Integrated Circuit (Thru-hole Pkg)
U 410	3-00357-340	MC10H106	Integrated Circuit (Thru-hole Pkg)
U 411	3-00359-340	MC10H125	Integrated Circuit (Thru-hole Pkg)
U 412	3-00358-340	74HC294	Integrated Circuit (Thru-hole Pkg)
U 413	3-00359-340	MC10H125	Integrated Circuit (Thru-hole Pkg)
U 414	3-00194-340	MC10H131	Integrated Circuit (Thru-hole Pkg)
U 501	3-00194-340	MC10H131	Integrated Circuit (Thru-hole Pkg)
U 503	3-00359-340	MC10H125	Integrated Circuit (Thru-hole Pkg)
U 504	3-00238-340	74F74	Integrated Circuit (Thru-hole Pkg)
U 505	3-00207-340	74F191	Integrated Circuit (Thru-hole Pkg)
U 506	3-00466-340	74HCT191	Integrated Circuit (Thru-hole Pkg)
U 507	3-00466-340	74HCT191	Integrated Circuit (Thru-hole Pkg)
U 508	3-00467-340	74HCT74	Integrated Circuit (Thru-hole Pkg)
U 509	3-00400-340	74HCT32	Integrated Circuit (Thru-hole Pkg)
U 511	3-00406-340	74HCT374	Integrated Circuit (Thru-hole Pkg)
U 512	3-00356-340	74F374	Integrated Circuit (Thru-hole Pkg)
U 513	3-00180-340	MC10H107	Integrated Circuit (Thru-hole Pkg)

Part List

U 514	3-00206-340	MC10H102	Integrated Circuit (Thru-hole Pkg)
U 601	3-00194-340	MC10H131	Integrated Circuit (Thru-hole Pkg)
U 602	3-00359-340	MC10H125	Integrated Circuit (Thru-hole Pkg)
U 603	3-00238-340	74F74	Integrated Circuit (Thru-hole Pkg)
U 604	3-00207-340	74F191	Integrated Circuit (Thru-hole Pkg)
U 605	3-00466-340	74HCT191	Integrated Circuit (Thru-hole Pkg)
U 606	3-00466-340	74HCT191	Integrated Circuit (Thru-hole Pkg)
U 607	3-00356-340	74F374	Integrated Circuit (Thru-hole Pkg)
U 608	3-00406-340	74HCT374	Integrated Circuit (Thru-hole Pkg)
U 701	3-00180-340	MC10H107	Integrated Circuit (Thru-hole Pkg)
U 702	3-00194-340	MC10H131	Integrated Circuit (Thru-hole Pkg)
U 703	3-00194-340	MC10H131	Integrated Circuit (Thru-hole Pkg)
U 704	3-00194-340	MC10H131	Integrated Circuit (Thru-hole Pkg)
U 705	3-00355-340	MC10H141	Integrated Circuit (Thru-hole Pkg)
U 706	3-00355-340	MC10H141	Integrated Circuit (Thru-hole Pkg)
U 707	3-00355-340	MC10H141	Integrated Circuit (Thru-hole Pkg)
U 708	3-00355-340	MC10H141	Integrated Circuit (Thru-hole Pkg)
U 709	3-00359-340	MC10H125	Integrated Circuit (Thru-hole Pkg)
U 710	3-00359-340	MC10H125	Integrated Circuit (Thru-hole Pkg)
U 711	3-00359-340	MC10H125	Integrated Circuit (Thru-hole Pkg)
U 712	3-00359-340	MC10H125	Integrated Circuit (Thru-hole Pkg)
U 713	3-00356-340	74F374	Integrated Circuit (Thru-hole Pkg)
U 714	3-00356-340	74F374	Integrated Circuit (Thru-hole Pkg)
U 1501	3-00200-340	MC10124	Integrated Circuit (Thru-hole Pkg)
U 1502	3-00200-340	MC10124	Integrated Circuit (Thru-hole Pkg)
U 1503	3-00200-340	MC10124	Integrated Circuit (Thru-hole Pkg)
Z 0	0-00025-005	3/8"	Lugs
Z 0	0-00089-033	4"	Tie
Z 0	0-00122-053	2-1/4" #24	Wire #24 UL1007 Strip 1/4x1/4 Tin
Z 0	0-00163-007	TO-5	Heat Sinks
Z 0	0-00165-003	TO-18	Insulators
Z 0	0-00407-032	SOLDR SLV RG174	Termination
Z 0	1-00073-120	INSL	Connector, BNC
Z 0	5-00027-503	.01U	Capacitor, Ceramic Disc, 50V, +80/-20%, Z5U
Z 0	5-00100-517	2.2U	Capacitor, Tantalum, 35V, 20%, Rad
Z 0	6-00212-630	1"X.25"CYL	Ferrite Beads
Z 0	6-00213-630	2-HOLE	Ferrite Beads
Z 0	7-00282-720	SR430-22	Fabricated Part

TTL LOGIC BOARD

<u>REF.</u>	<u>SRS part</u>	<u>VALUE</u>	<u>DESCRIPTION</u>
C 1	5-00100-517	2.2U	Capacitor, Tantalum, 35V, 20%, Rad
C 2	5-00225-548	.1U AXIAL	Capacitor, Ceramic, 50V, +80/-20% Z5U AX
C 3	5-00225-548	.1U AXIAL	Capacitor, Ceramic, 50V, +80/-20% Z5U AX
C 4	5-00225-548	.1U AXIAL	Capacitor, Ceramic, 50V, +80/-20% Z5U AX
C 5	5-00225-548	.1U AXIAL	Capacitor, Ceramic, 50V, +80/-20% Z5U AX
C 6	5-00225-548	.1U AXIAL	Capacitor, Ceramic, 50V, +80/-20% Z5U AX
C 7	5-00225-548	.1U AXIAL	Capacitor, Ceramic, 50V, +80/-20% Z5U AX
C 8	5-00225-548	.1U AXIAL	Capacitor, Ceramic, 50V, +80/-20% Z5U AX
C 9	5-00225-548	.1U AXIAL	Capacitor, Ceramic, 50V, +80/-20% Z5U AX

Part List

C 65	5-00225-548	.1U AXIAL	Capacitor, Ceramic, 50V,+80/-20% Z5U AX
C 801	5-00052-512	.01U	Cap, Stacked Metal Film 50V 5% -40/+85c
C 901	5-00052-512	.01U	Cap, Stacked Metal Film 50V 5% -40/+85c
C 902	5-00052-512	.01U	Cap, Stacked Metal Film 50V 5% -40/+85c
C 903	5-00052-512	.01U	Cap, Stacked Metal Film 50V 5% -40/+85c
C 904	5-00002-501	100P	Capacitor, Ceramic Disc, 50V, 10%, SL
C 1301	5-00002-501	100P	Capacitor, Ceramic Disc, 50V, 10%, SL
C 1601	5-00008-501	22P	Capacitor, Ceramic Disc, 50V, 10%, SL
C 1602	5-00023-529	.1U	Cap, Monolythic Ceramic, 50V, 20%, Z5U
C 1603	5-00023-529	.1U	Cap, Monolythic Ceramic, 50V, 20%, Z5U
C 1604	5-00061-513	.001U	Capacitor, Mylar/Poly, 50V, 5%, Rad
C 1605	5-00061-513	.001U	Capacitor, Mylar/Poly, 50V, 5%, Rad
JP801	1-00110-130	30 PIN DIL	Connector, Male
JP1200	1-00038-130	40 PIN DIL	Connector, Male
JP1201	1-00038-130	40 PIN DIL	Connector, Male
JP1601	1-00035-130	20 PIN DIL	Connector, Male
JP1602	1-00038-130	40 PIN DIL	Connector, Male
JP1603	1-00114-116	10 PIN, WHITE	Header, Amp, MTA-156
N 801	4-00650-426	10X150/.01U	Resistor/Capacitor Network
N 802	4-00650-426	10X150/.01U	Resistor/Capacitor Network
N 1001	4-00592-425	4.7KX9	Resistor Network SIP 1/4W 2% (Common)
N 1002	4-00592-425	4.7KX9	Resistor Network SIP 1/4W 2% (Common)
N 1003	4-00592-425	4.7KX9	Resistor Network SIP 1/4W 2% (Common)
N 1004	4-00592-425	4.7KX9	Resistor Network SIP 1/4W 2% (Common)
P 1601	4-00008-440	500	Trim Pot, Single Turn, In-Line Leads
PC1	7-00241-701	SR430-TTL	Printed Circuit Board
Q 1001	3-00026-325	2N5210	Transistor, TO-92 Package
Q 1002	3-00026-325	2N5210	Transistor, TO-92 Package
R 801	4-00041-401	150	Resistor, Carbon Film, 1/4W, 5%
R 901	4-00027-401	1.5K	Resistor, Carbon Film, 1/4W, 5%
R 902	4-00041-401	150	Resistor, Carbon Film, 1/4W, 5%
R 903	4-00041-401	150	Resistor, Carbon Film, 1/4W, 5%
R 904	4-00041-401	150	Resistor, Carbon Film, 1/4W, 5%
R 1001	4-00034-401	10K	Resistor, Carbon Film, 1/4W, 5%
R 1002	4-00034-401	10K	Resistor, Carbon Film, 1/4W, 5%
R 1301	4-00027-401	1.5K	Resistor, Carbon Film, 1/4W, 5%
R 1302	4-00027-401	1.5K	Resistor, Carbon Film, 1/4W, 5%
R 1303	4-00086-401	51	Resistor, Carbon Film, 1/4W, 5%
R 1304	4-00065-401	3.3K	Resistor, Carbon Film, 1/4W, 5%
R 1305	4-00034-401	10K	Resistor, Carbon Film, 1/4W, 5%
R 1306	4-00021-401	1.0K	Resistor, Carbon Film, 1/4W, 5%
R 1307	4-00079-401	4.7K	Resistor, Carbon Film, 1/4W, 5%
R 1308	4-00021-401	1.0K	Resistor, Carbon Film, 1/4W, 5%
R 1309	4-00034-401	10K	Resistor, Carbon Film, 1/4W, 5%
R 1601	4-00164-407	20.0K	Resistor, Metal Film, 1/8W, 1%, 50PPM
R 1602	4-00138-407	10.0K	Resistor, Metal Film, 1/8W, 1%, 50PPM
R 1603	4-00206-407	8.06K	Resistor, Metal Film, 1/8W, 1%, 50PPM
R 1604	4-00057-401	220	Resistor, Carbon Film, 1/4W, 5%
R 1605	4-00130-407	1.00K	Resistor, Metal Film, 1/8W, 1%, 50PPM
R 1606	4-00185-407	4.02K	Resistor, Metal Film, 1/8W, 1%, 50PPM
R 1607	4-00130-407	1.00K	Resistor, Metal Film, 1/8W, 1%, 50PPM
R 1608	4-00057-401	220	Resistor, Carbon Film, 1/4W, 5%
R 1609	4-00185-407	4.02K	Resistor, Metal Film, 1/8W, 1%, 50PPM
R 1610	4-00034-401	10K	Resistor, Carbon Film, 1/4W, 5%
R 1611	4-00034-401	10K	Resistor, Carbon Film, 1/4W, 5%

Part List

U 801	3-00367-341	8KX8-45	STATIC RAM, I.C.
U 802	3-00367-341	8KX8-45	STATIC RAM, I.C.
U 803	3-00367-341	8KX8-45	STATIC RAM, I.C.
U 804	3-00367-341	8KX8-45	STATIC RAM, I.C.
U 805	3-00299-341	32KX8-100L	STATIC RAM, I.C.
U 806	3-00365-340	74F157	Integrated Circuit (Thru-hole Pkg)
U 901	6-00073-621	16.000 MHZ	Crystal Oscillator
U 902	3-00274-340	74AC74	Integrated Circuit (Thru-hole Pkg)
U 903	3-00048-340	74HC73	Integrated Circuit (Thru-hole Pkg)
U 904	3-00360-340	74F32	Integrated Circuit (Thru-hole Pkg)
U 905	3-00238-340	74F74	Integrated Circuit (Thru-hole Pkg)
U 906	3-00238-340	74F74	Integrated Circuit (Thru-hole Pkg)
U 907	3-00360-340	74F32	Integrated Circuit (Thru-hole Pkg)
U 908	3-00207-340	74F191	Integrated Circuit (Thru-hole Pkg)
U 909	3-00207-340	74F191	Integrated Circuit (Thru-hole Pkg)
U 910	3-00207-340	74F191	Integrated Circuit (Thru-hole Pkg)
U 911	3-00207-340	74F191	Integrated Circuit (Thru-hole Pkg)
U 912	3-00361-340	74F373	Integrated Circuit (Thru-hole Pkg)
U 913	3-00361-340	74F373	Integrated Circuit (Thru-hole Pkg)
U 1001	3-00044-340	74HC244	Integrated Circuit (Thru-hole Pkg)
U 1002	3-00363-340	74HCT354	Integrated Circuit (Thru-hole Pkg)
U 1003	3-00044-340	74HC244	Integrated Circuit (Thru-hole Pkg)
U 1004	3-00363-340	74HCT354	Integrated Circuit (Thru-hole Pkg)
U 1005	3-00045-340	74HC32	Integrated Circuit (Thru-hole Pkg)
U 1006	3-00362-340	74F283	Integrated Circuit (Thru-hole Pkg)
U 1007	3-00362-340	74F283	Integrated Circuit (Thru-hole Pkg)
U 1008	3-00362-340	74F283	Integrated Circuit (Thru-hole Pkg)
U 1009	3-00362-340	74F283	Integrated Circuit (Thru-hole Pkg)
U 1010	3-00356-340	74F374	Integrated Circuit (Thru-hole Pkg)
U 1011	3-00356-340	74F374	Integrated Circuit (Thru-hole Pkg)
U 1012	3-00299-341	32KX8-100L	STATIC RAM, I.C.
U 1013	3-00299-341	32KX8-100L	STATIC RAM, I.C.
U 1014	3-00046-340	74HC374	Integrated Circuit (Thru-hole Pkg)
U 1015	3-00046-340	74HC374	Integrated Circuit (Thru-hole Pkg)
U 1016	3-00044-340	74HC244	Integrated Circuit (Thru-hole Pkg)
U 1017	3-00299-341	32KX8-100L	STATIC RAM, I.C.
U 1018	3-00299-341	32KX8-100L	STATIC RAM, I.C.
U 1019	3-00044-340	74HC244	Integrated Circuit (Thru-hole Pkg)
U 1020	3-00364-340	74F86	Integrated Circuit (Thru-hole Pkg)
U 1021	3-00364-340	74F86	Integrated Circuit (Thru-hole Pkg)
U 1022	3-00364-340	74F86	Integrated Circuit (Thru-hole Pkg)
U 1023	3-00364-340	74F86	Integrated Circuit (Thru-hole Pkg)
U 1101	3-00045-340	74HC32	Integrated Circuit (Thru-hole Pkg)
U 1103	3-00171-340	74HC191	Integrated Circuit (Thru-hole Pkg)
U 1104	3-00171-340	74HC191	Integrated Circuit (Thru-hole Pkg)
U 1105	3-00171-340	74HC191	Integrated Circuit (Thru-hole Pkg)
U 1106	3-00171-340	74HC191	Integrated Circuit (Thru-hole Pkg)
U 1107	3-00165-340	74HC08	Integrated Circuit (Thru-hole Pkg)
U 1201	3-00342-340	74ALS138	Integrated Circuit (Thru-hole Pkg)
U 1301	3-00044-340	74HC244	Integrated Circuit (Thru-hole Pkg)
U 1302	3-00046-340	74HC374	Integrated Circuit (Thru-hole Pkg)
U 1303	3-00046-340	74HC374	Integrated Circuit (Thru-hole Pkg)
U 1304	3-00046-340	74HC374	Integrated Circuit (Thru-hole Pkg)
U 1305	3-00046-340	74HC374	Integrated Circuit (Thru-hole Pkg)
U 1306	3-00046-340	74HC374	Integrated Circuit (Thru-hole Pkg)

Part List

U 1308	3-00049-340	74HC74	Integrated Circuit (Thru-hole Pkg)
U 1309	3-00049-340	74HC74	Integrated Circuit (Thru-hole Pkg)
U 1408	3-00155-340	74HC04	Integrated Circuit (Thru-hole Pkg)
U 1602	3-00059-340	AD7542JN	Integrated Circuit (Thru-hole Pkg)
U 1603	3-00087-340	LF347	Integrated Circuit (Thru-hole Pkg)
U 1604	3-00076-340	DG211	Integrated Circuit (Thru-hole Pkg)

HARDWARE

<u>REF.</u>	<u>SRS part</u>	<u>VALUE</u>	<u>DESCRIPTION</u>
F 5	6-00004-611	1A 3AG	Fuse
Z 0	0-00014-002	6J4	Power_Entry Hardware
Z 0	0-00043-011	4-40 KEP	Nut, Kep
Z 0	0-00048-011	6-32 KEP	Nut, Kep
Z 0	0-00079-031	4-40X3/16 M/F	Standoff
Z 0	0-00084-032	36154	Termination
Z 0	0-00089-033	4"	Tie
Z 0	0-00098-042	#6 LOCK	Washer, lock
Z 0	0-00113-053	10" #24	Wire #24 UL1007 Strip 1/4x1/4 Tin
Z 0	0-00116-050	11-3/4"#18	Wire #18 UL1007 Stripped 3/8x3/8 No Tin
Z 0	0-00120-050	16" #18	Wire #18 UL1007 Stripped 3/8x3/8 No Tin
Z 0	0-00123-053	21" #24	Wire #24 UL1007 Strip 1/4x1/4 Tin
Z 0	0-00124-053	22-1/2"#24	Wire #24 UL1007 Strip 1/4x1/4 Tin
Z 0	0-00126-053	3-1/2" #24	Wire #24 UL1007 Strip 1/4x1/4 Tin
Z 0	0-00136-053	8-1/2" #24	Wire #24 UL1007 Strip 1/4x1/4 Tin
Z 0	0-00149-020	4-40X1/4PF	Screw, Flathead Phillips
Z 0	0-00168-023	6-32X5/16R	Screw, Roundhead Phillips
Z 0	0-00187-021	4-40X1/4PP	Screw, Panhead Phillips
Z 0	0-00190-030	#8X1"	Spacer
Z 0	0-00210-020	4-40X5/16PF	Screw, Flathead Phillips
Z 0	0-00212-021	6-32X2PP	Screw, Panhead Phillips
Z 0	0-00241-021	4-40X3/16PP	Screw, Panhead Phillips
Z 0	0-00248-026	10-32X3/8TRUSSP	Screw, Black, All Types
Z 0	0-00256-043	#6 SHOULDER	Washer, nylon
Z 0	0-00257-000	HANDLE3	Hardware, Misc.
Z 0	0-00259-021	4-40X1/2"PP	Screw, Panhead Phillips
Z 0	0-00287-053	8.5 #24 GRN	Wire #24 UL1007 Strip 1/4x1/4 Tin
Z 0	0-00310-010	HEX 3/8-32	Nut, Hex
Z 0	0-00318-004	SR430	Knobs
Z 0	0-00320-004	SR430 CAP	Knobs
Z 0	0-00330-050	5-1/2" #18	Wire #18 UL1007 Stripped 3/8x3/8 No Tin
Z 0	0-00331-031	4-40X5/8 F/F	Standoff
Z 0	0-00335-000	FAN GUARD 2	Hardware, Misc.
Z 0	0-00336-027	#4X1/4PP-B	Screw, Sheet Metal
Z 0	0-00337-027	#4X3/8PP-B	Screw, Sheet Metal
Z 0	0-00338-023	2-56X1/4RP	Screw, Roundhead Phillips
Z 0	0-00339-042	#2 LOCK	Washer, lock
Z 0	0-00340-016	F0204	Power Button
Z 0	0-00343-027	#4X1/4PF-B	Screw, Sheet Metal
Z 0	0-00368-053	21" #24	Wire #24 UL1007 Strip 1/4x1/4 Tin
Z 0	0-00369-053	21" #24	Wire #24 UL1007 Strip 1/4x1/4 Tin
Z 0	0-00394-031	6-32X13/16	Standoff

Part List

Z 0	0-00415-031	4-40X1/2 M/F	Standoff
Z 0	0-00416-020	8-32X1/4PF	Screw, Flathead Phillips
Z 0	0-00418-000	CLIP, CABLE	Hardware, Misc.
Z 0	0-00443-000	SWITCH	Hardware, Misc.
Z 0	0-00466-050	23" #18 BLACK	Wire #18 UL1007 Stripped 3/8x3/8 No Tin
Z 0	0-00467-050	23" #18 RED	Wire #18 UL1007 Stripped 3/8x3/8 No Tin
Z 0	0-00500-000	554808-1	Hardware, Misc.
Z 0	0-00521-048	3" #18	Wire, #18 UL1015 Strip 3/8 x 3/8 No Tin
Z 0	0-00527-050	13" #18	Wire #18 UL1007 Stripped 3/8x3/8 No Tin
Z 0	0-00893-026	8-32X3/8PF	Screw, Black, All Types
Z 0	1-00002-113	10 PIN,18AWG/OR	Connector, Amp, MTA-156
Z 0	1-00003-120	BNC	Connector, BNC
Z 0	1-00033-113	5 PIN, 18AWG/OR	Connector, Amp, MTA-156
Z 0	1-00073-120	INSL	Connector, BNC
Z 0	1-00076-171	4 PIN SIL	Cable Assembly, Ribbon
Z 0	1-00110-130	30 PIN DIL	Connector, Male
Z 0	1-00118-113	20 PIN,18AWG/OR	Connector, Amp, MTA-156
Z 0	1-00120-113	3 PIN, 18AWG/OR	Connector, Amp, MTA-156
Z 0	1-00121-131	4 PIN DIF DISK	Connector, Female
Z 0	1-00128-171	20 COND	Cable Assembly, Ribbon
Z 0	1-00131-171	30 COND DIL	Cable Assembly, Ribbon
Z 0	1-00132-171	34 COND	Cable Assembly, Ribbon
Z 0	1-00133-171	40 COND	Cable Assembly, Ribbon
Z 0	1-00134-171	40 COND	Cable Assembly, Ribbon
Z 0	1-00138-130	5 PIN SI	Connector, Male
Z 0	1-00141-171	5 PIN SIL	Cable Assembly, Ribbon
Z 0	1-00183-171	20 COND	Cable Assembly, Ribbon
Z 0	1-00193-131	12 PIN SIF	Connector, Female
Z 0	2-00023-218	DPDT	Switch, Panel Mount, Power, Rocker
Z 0	2-00034-220	ENA1J-B20	SOFTPOT
Z 0	2-00035-222	SAS50B	Thermostat
Z 0	4-00649-455	100K	Trim Pot, Cond. Plastic, PC Mount
Z 0	4-00681-436	SG240	Thermistor, ICL (Inrush Current Limiter)
Z 0	6-00059-610	PLATFORM	Transformer
Z 0	6-00076-600	2" SPKR	Misc. Components
Z 0	6-00213-630	2-HOLE	Ferrite Beads
Z 0	7-00124-720	TRANSCOVER2-MOD	Fabricated Part
Z 0	7-00254-721	PLTFM-4	Machined Part
Z 0	7-00270-735	PLTFM-7	Injection Molded Plastic
Z 0	7-00272-735	PLTFM-9	Injection Molded Plastic
Z 0	7-00275-740	SR430	Keypad, Conductive Rubber
Z 0	7-00276-720	SR430-20	Fabricated Part
Z 0	7-00277-711	SR430-21	Rear Panel
Z 0	7-00281-720	PLTFM-18	Fabricated Part
Z 0	7-00284-720	PLTFM-20	Fabricated Part
Z 0	7-00286-720	7" CRT SCREEN	Fabricated Part
Z 0	7-00287-721	PLTFM-23	Machined Part
Z 0	7-00289-720	PLTFM-26	Fabricated Part
Z 0	7-00291-709	SR430-23 TO 25	Lexan Overlay
Z 0	7-00292-720	PLTFM-27	Fabricated Part
Z 0	7-00350-720	PLTFM-29	Fabricated Part
Z 0	7-00396-701	PLTFM FP	Printed Circuit Board
Z 0	7-00414-720	SR770-17	Fabricated Part
Z 0	7-00431-720	SR770-21/22	Fabricated Part
Z 0	7-00435-720	SR770-26	Fabricated Part

Part List

Z 0	7-00473-720	SR770-27/28/29	Fabricated Part
Z 0	8-00034-850	FLOPPY	Disk Drive
Z 0	8-00040-840	7" Z-AXIS	CRT Display
Z 0	9-00267-917	GENERIC	Product Labels

MISCELLANEOUS

<u>REF.</u>	<u>SRS part</u>	<u>VALUE</u>	<u>DESCRIPTION</u>
U 301	3-00345-342	64KX8-120	EPROM/PROM, I.C.
U 302	3-00345-342	64KX8-120	EPROM/PROM, I.C.
U 303	3-00345-342	64KX8-120	EPROM/PROM, I.C.
U 304	3-00345-342	64KX8-120	EPROM/PROM, I.C.
Z 0	0-00159-000	FAN GUARD	Hardware, Misc.
Z 0	0-00179-000	RIGHT FOOT	Hardware, Misc.
Z 0	0-00180-000	LEFT FOOT	Hardware, Misc.
Z 0	0-00185-021	6-32X3/8PP	Screw, Panhead Phillips
Z 0	0-00204-000	REAR FOOT	Hardware, Misc.
Z 0	0-00223-029	6-32X3/8TR PH	Screw, Truss Phillips
Z 0	0-00248-026	10-32X3/8TRUSSP	Screw, Black, All Types
Z 0	0-00259-021	4-40X1/2"PP	Screw, Panhead Phillips
Z 0	0-00315-021	6-32X7/16 PP	Screw, Panhead Phillips
Z 0	7-00147-720	BAIL	Fabricated Part
Z 0	7-00394-720	SR770-6	Fabricated Part
Z 0	7-00395-720	SR770-7	Fabricated Part



Stanford Research Systems

1290 D Reamwood Avenue, Sunnyvale, CA 94089

Phone: 408-744-9040 FAX: 408-744-9049

email: info@thinkSRS.com Web: www.thinkSRS.com

Addendum

RE: Disk Utilities of the SR430

Date: Sept. 10, 2002

Some of the SRS instruments have build-in floppy disk drives. The SR430 only works properly with low-density disks (DS/DD).

Recently, it has become increasingly difficult to find low-density disks (DS/DD). However there is a quick and easy way to convert a high-density disk to a low density one. Just follow the procedure below:

1. Orient the high-density disk so that the label side is facing up and the metal "slider" is facing down. Notice there are two small rectangular holes on the top of the floppy disk.
2. Use a single piece of sturdy tape (must be opaque) to cover both sides of the hole at the upper-left corner of the floppy disk. Be sure to stretch the tape tightly so that it will not sag.
3. Format the disk in one of the above mentioned instruments.